

Paper 5

Past Exam Questions

Organised by Experiment Type

Summer 2002 to Winter 2021 (46 Papers)

Name: _____

Class: _____

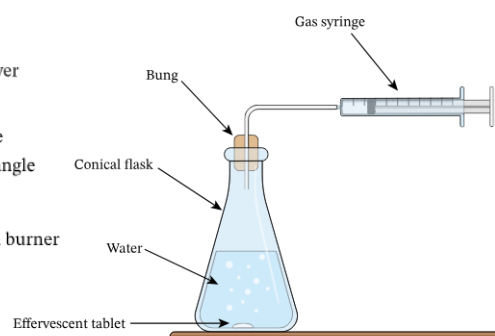
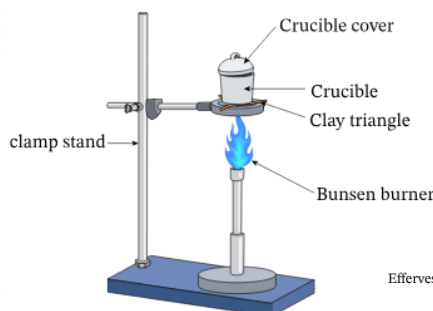
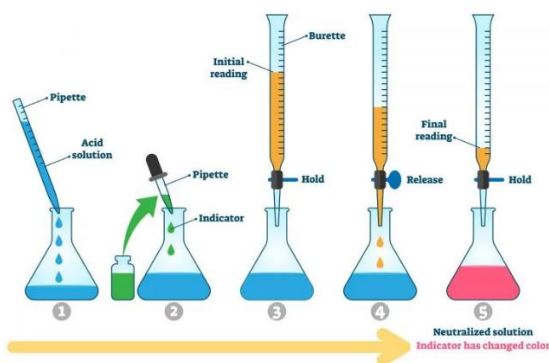
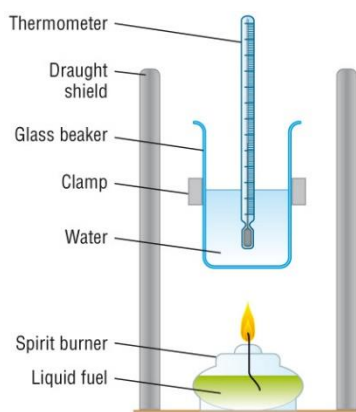

Contents

Calendars and time management	3
Planning your days.....	5
ALvI ALL P5 Analysis Experiment and question types – Notes and points of interest.....	9
Graph analysis of mark frequencies for specific syllabus topics and of experiment type	10
Tables of analysis of mark frequencies for specific syllabus topics and of experiment type.....	11
ALvI ALL P5 Analysis Experiment and question types – ordered by time	12
ALvI ALL P5 Analysis Experiment and question types – ordered by experiment type then topic #	17
CAIE A Level Chemistry 9701 Syllabus Details for Paper 5 (pages 64-7)	27
Paper 5 Exam Questions	35
Rate experiment	35
Titration	114
Gas volumes.....	162
States of matter	206
Electrolysis	258
Thermometric	288
Miscellaneous	331
Gravimetric	341
Thermometric titration.....	385
Mark Scheme	402
Rate experiment MS	402
Titration MS	432
Gas volume MS	449
States of matter MS.....	465
Electrolysis MS.....	491
Thermometric MS.....	499
Miscellaneous MS.....	519
Gravimetric MS	521
Thermometric titration MS.....	544
Important values, constants, and standards & The Periodic Table.....	555

Scan this code for an electronic version of this book:



Calendars and time management

Organising your months in 2024

January						
S	M	T	W	T	F	S
	1	2	3	4	5	6
7	8	9	10	11	12	13
14	15	16	17	18	19	20
21	22	23	24	25	26	27
28	29	30	31			

February						
S	M	T	W	T	F	S
				1	2	3
4	5	6	7	8	9	10
11	12	13	14	15	16	17
18	19	20	21	22	23	24
25	26	27	28	29		

March						
S	M	T	W	T	F	S
					1	2
3	4	5	6	7	8	9
10	11	12	13	14	15	16
17	18	19	20	21	22	23
24	25	26	27	28	29	30
31						

April						
S	M	T	W	T	F	S
	1	2	3	4	5	6
7	8	9	10	11	12	13
14	15	16	17	18	19	20
21	22	23	24	25	26	27
28	29	30				

May						
S	M	T	W	T	F	S
			1	2	3	4
5	6	7	8	9	10	11
12	13	14	15	16	17	18
19	20	21	22	23	24	25
26	27	28	29	30	31	

June						
S	M	T	W	T	F	S
						1
2	3	4	5	6	7	8
9	10	11	12	13	14	15
16	17	18	19	20	21	22
23	24	25	26	27	28	29
30						

CAIE Chemistry 9701 A Level Chemistry Exam Timetable for Administrative Zone 5 (Time Zone 2):

Chemistry (Multiple Choice)	9701/12	1h 15m	Tuesday 04 June 2024	PM
Chemistry	9701/22	1h 15m	Wednesday 15 May 2024	PM
Chemistry (Practical - Advanced)	9701/33	2h	Thursday 02 May 2024	PM
Chemistry (Practical - Advanced)	9701/34	2h	Thursday 30 May 2024	PM

Organising your weeks

Week Starting	Wk #	Events	Topic Focus
15-Jan	1		
22-Jan	2		
29-Jan	3		
5-Feb	4		
12-Feb	5		
19-Feb	6		



Week Starting	Wk #	Events	Topic Focus
26-Feb	7		
4-Mar	8		
11-Mar	9		
18-Mar	10		
25-Mar	11		
1-Apr	12		
8-Apr	13		
15-Apr	14		
22-Apr	15		
29-Apr	16	Thur 2 nd PM Paper 33 (TZ2)	
6-May	17	Wed 8 th PM Paper 4 (TZ2)	
13-May	18	Wed 15 th PM Paper 2 (TZ2) Wed 15 th PM Paper 5 (TZ2)	
20-May	19		
27-May	20	Thur 30 th PM Paper 34 (TZ2)	
3-Jun	21	Tues 4 th PM Paper 1 (TZ2)	
10-Jun	22		
17-Jun	23		
24-Jun	24		



Planning your days

V1.0

Period	Time	Monday	Tuesday	Wednesday	Thursday	Friday	Saturday	Sunday
	5:00 am							
	5:30 am							
	6:00 am							
	6:30 am							
	7:00 am							
Regstn	7:25 am							
1	7:50 am							
2	8:40 am							
3	9:30 am							
4	10:20 am							
5	11:00 am							
Lunch	11:50 pm							
6	1:10 pm							
7	2:00pm							
8	2:50 pm							
9	3:40 pm							
	4:20 pm							
	5:00 pm							
	5:30 pm							
	6:00 pm							
	6:30 pm							
	7:00 pm							
	7:30 pm							
	8:00 pm							
	8:30 pm							
	9:00 pm							
	9:30 pm							
	10:00 pm							
	10:30 pm							



Planning your days – v2.0

Period	Time	Monday	Tuesday	Wednesday	Thursday	Friday	Saturday	Sunday
	5:00 am							
	5:30 am							
	6:00 am							
	6:30 am							
	7:00 am							
Regstn	7:25 am							
1	7:50 am							
2	8:40 am							
3	9:30 am							
4	10:20 am							
5	11:00 am							
Lunch	11:50 pm							
6	1:10 pm							
7	2:00pm							
8	2:50 pm							
9	3:40 pm							
	4:20 pm							
	5:00 pm							
	5:30 pm							
	6:00 pm							
	6:30 pm							
	7:00 pm							
	7:30 pm							
	8:00 pm							
	8:30 pm							
	9:00 pm							
	9:30 pm							
	10:00 pm							
	10:30 pm							



Planning your days – v3.0

Period	Time	Monday	Tuesday	Wednesday	Thursday	Friday	Saturday	Sunday
	5:00 am							
	5:30 am							
	6:00 am							
	6:30 am							
	7:00 am							
Regstn	7:25 am							
1	7:50 am							
2	8:40 am							
3	9:30 am							
4	10:20 am							
5	11:00 am							
Lunch	11:50 pm							
6	1:10 pm							
7	2:00pm							
8	2:50 pm							
9	3:40 pm							
	4:20 pm							
	5:00 pm							
	5:30 pm							
	6:00 pm							
	6:30 pm							
	7:00 pm							
	7:30 pm							
	8:00 pm							
	8:30 pm							
	9:00 pm							
	9:30 pm							
	10:00 pm							
	10:30 pm							



Planning your days – v4.0

Period	Time	Monday	Tuesday	Wednesday	Thursday	Friday	Saturday	Sunday
	5:00 am							
	5:30 am							
	6:00 am							
	6:30 am							
	7:00 am							
Regstn	7:25 am							
1	7:50 am							
2	8:40 am							
3	9:30 am							
4	10:20 am							
5	11:00 am							
Lunch	11:50 pm							
6	1:10 pm							
7	2:00pm							
8	2:50 pm							
9	3:40 pm							
	4:20 pm							
	5:00 pm							
	5:30 pm							
	6:00 pm							
	6:30 pm							
	7:00 pm							
	7:30 pm							
	8:00 pm							
	8:30 pm							
	9:00 pm							
	9:30 pm							
	10:00 pm							
	10:30 pm							



ALvl ALL P5 Analysis Experiment and question types – Notes and points of interest

For topic numbers that are in the AS course these questions could be used to help students struggling with certain parts of Paper 3 better understand some thinking behind those experiment types, **but the skills assessed for Paper 3 and Paper 5 are not the same, so being really good at these questions may not improve your performance in Paper 3.**

Unusual experiments are highlighted in yellow, e.g. 2005/s/tz1/Q# 3/ is almost only marks assessing understanding of error.

No qualitative experiments in any questions were found.

Organic chemistry is almost entirely absent.

Before 2007 the bulk of the marks were for actually carrying out the quantitative experiment and delivering accurate results, as well as marks for the calculations. From 2007 and onwards a change in the syllabus removed an exam paper on optional A2 topics (Paper 6) and meant that Paper 5 is a written only exam, no longer done with a practical experimental work.

Drawing and interpreting graphs is statistically almost every other question, though some exam papers do not have any graphs in them.

Describing how to make a standard solution is a relatively common part to a question.

“States of matter” main experiments involving the states of substances:

- Boiling point
- Freezing point
- Precipitation
- Crystallization
- Mixing of liquids (e.g. partition coefficient)
- Viscosity (only 1 experiment)

Only 4 experiments cannot easily be categorized, the “Miscellaneous experiments” are investigations involving:

- optical rotation
- chromatography
- colorimetry
- conductance.

One way to approach this resource is to solve exam questions by experiment type, then approach each question type you struggle with, like describing standard solutions, by solving in reverse chronological order only that particular question type. First do the last 5 years, then going back in blocks of 5 years until you are performing on target.

Time for Paper 4 ought to be prioritised in a ratio of about 3 hours to every 1 hour of Paper 5:

Paper 4	Paper 5
A Level Structured Questions 100 marks Structured questions Questions are based on the A Level syllabus content; knowledge of material from the AS Level syllabus content will be required. Externally assessed 38.5% of the A Level	Planning, Analysis and Evaluation 30 marks Questions based on the experimental skills of planning, analysis and evaluation. The context of the questions may be outside the syllabus content. Externally assessed 11.5% of the A Level



Main changes in format, presentation and explanation across time

2006 and before P5 (30marks, 90mins) is more like paper 3, so need to do an experiment. Paper 6 also existed which were questions on the options.

For exam questions where this appears after the exam ID: **“EXPERIMENT Required, no longer needed from 2007 onwards.”** look at the method presented as one way to describe a method, for instance for a titration or a rate experiment, which may be asked for in questions from 2007 and onwards.

2007 first year which had two versions of paper 3. 2007 Paper 5 went from 90minutes to 75minutes 30marks, but no practical experiment part.

2010 introduced Time Zones 1, 2 and 3, before that only 1 paper for summer and winter series, so only 2 versions of each paper per year. (2009 only had w and s)

2012w and before each question section in the mark scheme are given their “Experimental skills and investigations” label.

2013s and onwards no longer gives details about the Skill Sections being assessed by each question.

2015s labels the marks allocated to the different skills:

- Method (M1 to 10)
- Problem Defining (P1 to 4)
- Data (D1 to 3)
- Evaluation (E1 to 5)
- Conclusions (C1 to 3)

2015w no longer gives details about the Skill Sections being assessed by each question.

2016 introduced the March series.

Graph analysis of mark frequencies for specific syllabus topics and of experiment type

Main changes to content across time:

The purple line with purple diamonds represents the last 10 years the darker blue with large black crosses shows the previous 6.5 years. The largest changes between them ranked in order of size of change are:

1. Gravimetric titrations were common before, investigating mass changes (e.g. to work out formulas through thermal decomposition, loss of water of crystallisation or impurities in group 2 oxides like the addition of nitrides), but are now very rare.
2. Electrolysis experiments are now far more common, before they were far rarer.
3. Miscellaneous experiments involving unusual things like optical rotation for optical isomerism, colourimetry, conductance, and chromatography are more common more recently

Tables of analysis of mark frequencies for specific syllabus topics and of experiment type

By topic number (descriptions relate to the subtopic the bulk of the questions deal with):

Topic #	02s to 23s	02s-06w	07s-13s	13w-23s
26 Rate A2	15.3	6.7	7.7	20.2
7 Acid base	7.2	10.1	0.0	11.2
24 Electrochemistry	7.9	0.0	3.9	10.5
6 Redox	9.2	15.8	7.7	9.8
4 States of matter	7.3	10.1	6.2	7.3
5 Enthalpy	7.0	14.8	7.7	7.3
27 Group 2 (thermal decomposition)	9.4	6.4	15.4	5.2
8 Rate AS	6.4	14.4	11.3	4.6
9 Periodicity	2.3	0.0	0.0	3.6
25 Equilibria	2.3	0.0	0.0	3.6
2 Stoichiometry	10.3	21.8	17.2	3.2
10 Group 2	1.9	0.0	0.0	3.0
11 Group 17 – halide precipitates	3.0	0.0	3.9	2.9
14 Organic chemistry	1.3	0.0	0.0	2.0
23 Lattice enthalpy	5.7	0.0	15.2	1.8
21 Organic synthesis	1.1	0.0	0.0	1.7
28 Transition elements	2.1	0.0	3.9	1.4
37 Chromatography	0.5	0.0	0.0	0.8
1	0.0	0.0	0.0	0.0
3	0.0	0.0	0.0	0.0
12	0.0	0.0	0.0	0.0
13	0.0	0.0	0.0	0.0
15	0.0	0.0	0.0	0.0
16	0.0	0.0	0.0	0.0
17	0.0	0.0	0.0	0.0
18	0.0	0.0	0.0	0.0
19	0.0	0.0	0.0	0.0
20	0.0	0.0	0.0	0.0
22	0.0	0.0	0.0	0.0
29	0.0	0.0	0.0	0.0
30	0.0	0.0	0.0	0.0
31	0.0	0.0	0.0	0.0
32	0.0	0.0	0.0	0.0
33	0.0	0.0	0.0	0.0
34	0.0	0.0	0.0	0.0
35	0.0	0.0	0.0	0.0
36	0.0	0.0	0.0	0.0

By experiment type:

Experiment type	02s to 23s	02s-06w	07s-13s	13w-23s	Rank
Rate	23.8	21.1	19.0	26.9	1
Titration	15.6	19.8	3.9	19.5	2
Gas Volumes	12.1	10.1	11.8	13.0	3
States	12.6	5.0	21.6	11.2	4
Electrolysis	5.9	0.0	3.9	8.9	5
Thermometric	10.5	14.8	11.6	8.6	6
Miscellaneous	3.8	0.0	0.0	6.9	7
Gravimetric	10.9	15.1	24.4	3.2	8
Thermal Titration	4.7	14.1	3.9	1.8	9



ALvl ALL P5 Analysis Experiment and question types – ordered by time

This table can be used to look for patterns and the consistency of those patterns across time.

Question ID and locator	Topic #	Main experiment	# marks	Additional experimental details	Additional experimental details	Q#	Graph	Apparatus				Results table: create	Calculation: describe	Prediction	Variables	Anomaly:	Accuracy	Precision	Error	%Error	Reliability	Health & safety	Improvement
								Draw & label	Set up (Method)	Name or describe													
2002/s/tz1/ p5/Q# 1/	6	Titration	19			1	1																
2002/s/tz1/ p5/Q# 2/	27	Gas volume	9	Thermal Decomposition		2		1														1	
2002/w/tz1/ p5/Q# 1/	8	Rate	21			1			1														
2002/w/tz1/ p5/Q# 2/	2	Gravimetric	9	Mass lost		2			1	1													
2003/s/tz1/ p5/Q# 1/	6	Titration	20			1																	
2003/s/tz1/ p5/Q# 2/	2	Gravimetric	10	Mass lost	Gas volume, Titration,	2				1	1												
2003/w/tz1/ p5/Q# 1/	5	Thermometric	25			1			1	1													
2003/w/tz1/ p5/Q# 2/	2	States of matter	5			2			1	1													
2004/s/tz1/ p5/Q# 1/	5	Thermometric	19			1	1																
2004/s/tz1/ p5/Q# 2/	2	Gas volume	11			2		1								1							
2004/w/tz1/ p5/Q# 1/	26	Rate	20			1																	
2004/w/tz1/ p5/Q# 2/	4	States of matter	10			2	1		1	1													
2005/s/tz1/ p5/Q# 1/	2	Gravimetric	8	Mass lost		1																	
2005/s/tz1/ p5/Q# 2/	2	Thermometric titration	12			2		1															
2005/s/tz1/ p5/Q# 3/	2	Gas volume	10	Titration		3												1	1				
2005/w/tz1/ p5/Q# 1/	4	Titration	20			1												1					
2005/w/tz1/ p5/Q# 2/	7	Thermometric titration	10			2				1													
2006/s/tz1/ p5/Q# 1/	8	Rate	22			1	1		1														
2006/s/tz1/ p5/Q# 2/	6	Gravimetric	8	Mass lost	Gas volume	2		1														1	
2006/w/tz1/ p5/Q# 1/	7	Thermometric titration	20			1		1															
2006/w/tz1/ p5/Q# 2/	27	Gravimetric	10	Mass lost		2			1														
2007/s/tz1/ p5/Q# 1/	8	Rate	15		Gas volume	1			1	1				1									

Question ID and locator	Topic #	Main experiment	# marks	Additional experimental details	Additional experimental details	Q #	Graph	Apparatus			Results table: create	Calculation: describe	Prediction	Variables	Anomaly:	Accuracy	Precision	Error	%Error	Reliability	Health & safety	Improvement
								Draw & label	Set up (Method)	Name or describe												
2007/s/tz1/ p5/Q# 2/	6	Gravimetric	15	Mass lost		2	1							1				1				
2007/w/tz1/ p5/Q# 1/	23	Thermometric	15			1		1	1	1		1	1				1				1	
2007/w/tz1/ p5/Q# 2/	8	Rate	14		Gas volume	2	1								1		1					
2008/s/tz1/ p5/Q# 1/	5	Thermometric	15			1			1	1	1	1	1									1
2008/s/tz1/ p5/Q# 2/	2	Gravimetric	15	Mass lost	Gas volume	2	1			1				1		1						1
2008/w/tz1/ p5/Q# 1/	23	States of matter	15			1			1	1			1									1
2008/w/tz1/ p5/Q# 2/	24	Electrolysis	15			2	1			1				1		1						
2009/s/tz1/ p5/Q# 1/	27	Gas volume	15	Thermal Decomposition		1		1					1									1
2009/s/tz1/ p5/Q# 2/	27	States of matter	15			2	1			1				1		1	1					
2009/w/tz1/ p5/Q# 1/	8	Rate	15			1			1				1			1						
2009/w/tz1/ p5/Q# 2/	2	Gravimetric	15			2				1				1			1					
2010/s/tz1/ p5/Q# 1/	5	Thermometric titration	15			1				1		1	1		1							1
2010/s/tz1/ p5/Q# 2/	4	States of matter	9			2	1							1								
2010/s/tz1/ p5/Q# 3/	2	Gravimetric	6	Mass gained		3								1			1					
2010/w/tz1/ p5/Q# 1/	2	States of matter	16			1			1				1									
2010/w/tz1/ p5/Q# 2/	23	States of matter	14			2	1			1		1		1								
2011/s/tz1/ p5/Q# 1/	27	Gas volume	16	Thermal Decomposition		1		1		1			1									1
2011/s/tz1/ p5/Q# 2/	27	Gravimetric	14	Mass lost	Thermal decomposition	2	1			1				1								
2011/w/tz1/ p5/Q# 1/	23	Thermometric	15			1			1													
2011/w/tz1/ p5/Q# 2/	26	Rate	15			2	1			1				1								1
2012/s/tz1/ p5/Q# 1/	28	States of matter	15			1			1				1									1
2012/s/tz1/ p5/Q# 2/	4	Gas volume	15			2	1			1				1								1
2012/w/tz1/ p5/Q# 1/	6	Gravimetric	15	Mass lost		1		1		1	1	1	1									1
2012/w/tz1/ p5/Q# 2/	26	Rate	15			2	1			1				1								1
2013/s/tz1/ p5/Q# 1/	11	Titration	15			1			1			1										1
2013/s/tz1/ p5/Q# 2/	2	Gravimetric	15	Mass lost		2	1							1								1

Question ID and locator	Topic #	Main experiment	# marks	Additional experimental details	Additional experimental details	Q #	Apparatus				Results table: create	Calculation: describe	Prediction	Variables	Anomaly:	Accuracy	Precision	Error	%Error	Reliability	Health & safety	Improvement
							Graph	Draw & label	Set up (Method)	Name or describe												
2013/w/tz1/ p5/Q# 1/	23	Thermometric	15			1		1					1									
2013/w/tz1/ p5/Q# 2/	27	States of matter	15			2	1					1		1				1				
2014/s/tz1/ p5/Q# 1/	27	Gas volume	15	Thermal Decomposition		1		1								1					1	
2014/s/tz1/ p5/Q# 2/	24	Electrolysis	15			2	1							1								
2014/w/tz1/ p5/Q# 1/	9	States of matter	15			1			1							1	1					
2014/w/tz1/ p5/Q# 2/	7	Titration	15	Standard solution		2								1			1					
2015/s/tz1/ p5/Q# 1/	7	Titration	15	Standard solution		1							1									
2015/s/tz1/ p5/Q# 2/	7	Gas volume	15			2	1					1										1
2015/w/tz1/ p5/Q# 1/	4	Gas volume	15			1		1										1				1
2015/w/tz1/ p5/Q# 2/	7	Thermometric titration	15			2	1					1				1	1					
2016/m/tz2/ p5/Q# 1/	26	Rate	20	Titration		1			1				1									
2016/m/tz2/ p5/Q# 2/	5	Thermometric	10			2	1											1				
2016/s/tz1/ p5/Q# 1/	9	Gas volume	15	Titration		1		1														1
2016/s/tz1/ p5/Q# 2/	26	Rate	15			2	1							1						1		
2016/w/tz1/ p5/Q# 1/	10	Titration	15	Standard solution		1			1													1
2016/w/tz1/ p5/Q# 2/	26	Rate	15			2	1							1								
2017/m/tz2/ p5/Q# 1/	5	Gravimetric	18	Mass lost	Thermal decomposition	1	1		1			1						1				
2017/m/tz2/ p5/Q# 2/	28	Miscellaneous	12	Standard solution	Colourimetry	2	1			1												1
2017/s/tz1/ p5/Q# 1/	5	Thermometric	12			1	1	1					1	1								
2017/s/tz1/ p5/Q# 2/	2	Miscellaneous	18	Standard solution	Optical rotation	2	1			1				1			1					
2017/w/tz1/ p5/Q# 1/	8	Rate	14			1				1						1		1				1
2017/w/tz1/ p5/Q# 2/	24	Electrolysis	16			2	1										1	1				
2018/m/tz2/ p5/Q# 1/	4	States of matter	16			1	1	1						1	1	1						
2018/m/tz2/ p5/Q# 2/	6	Titration	14			2			1													
2018/s/tz1/ p5/Q# 1/	24	Electrolysis	12			1		1										1				1
2018/s/tz1/ p5/Q# 2/	26	Rate	18		Gas volume	2	1	1														

Question ID and locator	Topic #	Main experiment	# marks	Additional experimental details	Additional experimental details	Q #	Apparatus				Results table: create	Calculation: describe	Prediction	Variables	Anomaly:	Accuracy	Precision	Error	%Error	Reliability	Health & safety	Improvement
							Graph	Draw & label	Set up (Method)	Name or describe												
2018/w/tz1/ p5/Q# 1/	26	Rate	14			1												1			1	
2018/w/tz1/ p5/Q# 2/	24	Electrolysis	16	Solubility product, K_{sp}		2	1		1	1												
2019/m/tz2/ p5/Q# 1/	26	Rate	20	Standard solution		1	1		1						1			1	1			
2019/m/tz2/ p5/Q# 2/	10	States of matter	10			2		1									1					
2019/s/tz1/ p5/Q# 1/	24	Electrolysis	16	Standard solution		1	1			1				1								
2019/s/tz1/ p5/Q# 2/	21	States of matter	14			2		1													1	
2019/w/tz1/ p5/Q# 1/	24	Titration	13	Standard solution		1				1												
2019/w/tz1/ p5/Q# 2/	4	Rate	17			2	1				1			1								
2020/m/tz2/ p5/Q# 1/	6	Titration	19			1			1						1			1				
2020/m/tz2/ p5/Q# 2/	8	Rate	11			2	1						1		1							
2020/s/tz1/ p5/Q# 1/	5	Thermometric	11			1			1			1					1			1	1	
2020/s/tz1/ p5/Q# 2/	7	Gas volume	19			2	1	1		1					1							1
2020/w/tz1/ p5/Q# 1/	6	Titration	13	Standard solution		1				1								1				
2020/w/tz1/ p5/Q# 2/	14	Gas volume	17			2	1							1					1	1	1	1
2021/m/tz2/ p5/Q# 1/	5	Thermometric	10			1	1	1									1					
2021/m/tz2/ p5/Q# 2/	6	Titration	20	Standard solution		2				1	1											
2021/s/tz1/ p5/Q# 1/	8	Rate	14		Gas volume	1		1					1						1	1		
2021/s/tz1/ p5/Q# 2/	6	Titration	16			2									1		1	1				
2021/w/tz1/ p5/Q# 1/	27	Thermometric	14	Thermal Decomposition		1			1									1				1
2021/w/tz1/ p5/Q# 2/	26	Rate	16		Gas volume	2	1	1					1	1								
2022/m/tz2/ p5/Q# 1/	2	Gravimetric	9	Mass lost		1			1	1								1				
2022/m/tz2/ p5/Q# 2/	25	Miscellaneous	21	Standard solution	Conductivity	2	1							1				1	1	1	1	
2022/s/tz1/ p5/Q# 1/	11	States of matter	14	Standard solution		1	1			1					1			1	1			1
2022/s/tz1/ p5/Q# 2/	26	Rate	16	Titration		2	1			1			1	1							1	
2022/w/tz1/ p5/Q# 1/	11	States of matter	10			1			1									1				
2022/w/tz1/ p5/Q# 2/	4	Gas volume	13			2	1	1					1	1					1	1		
2022/w/tz1/ p5/Q# 3/	26	Rate	7	Standard solution		3				1												

Question ID and locator	Topic #	Main experiment	# marks	Additional experimental details	Additional experimental details	Q #	Graph	Apparatus			Results table: create	Calculation: describe	Prediction	Variables	Anomaly:	Accuracy	Precision	Error	%Error	Reliability	Health & safety	Improvement
								Draw & label	Set up (Method)	Name or describe												
2023/m/tz2/ p5/Q# 1/	7	Titration	15			1			1										1			
2023/m/tz2/ p5/Q# 2/	26	Rate	15	Standard solution		2	1		1				1	1			1	1				
2023/s/tz2/ p5/Q# 1/	25	Titration	9	Partition coefficient, K_{pc}		1			1			1									1	
2023/s/tz2/ p5/Q# 2/	37	Miscellaneous	7		Chromatography	2			1												1	
2023/s/tz2/ p5/Q# 3/	26	Rate	14	Standard solution	Gas volume	3	1		1					1								
Totals			1527				47	22	33	14	26	4	12	21	30	10	9	17	21	12	27	7



ALvl ALL P5 Analysis Experiment and question types – ordered by experiment type then topic

This table allows you to more easily find specific questions because this is the order that they are in in the revision books.

Question ID and locator	Topic #	Main experiment	# marks	Rank (last 10 years)	Additional experimental details	Additional experimental details	Q #	Apparatus				Results table: create	Calculation: describe	Prediction	Variables	Anomaly:	Accuracy	Precision	Error	%Error	Reliability	Health & safety	Improvement
								Graph	Draw & label	Set up (Method)	Name or describe												
2019/w/tz1/ p5/Q# 2/	4	Rate	17	1			2	1					1		1								
2002/w/tz1/ p5/Q# 1/	8	Rate	21	1			1			1													
2006/s/tz1/ p5/Q# 1/	8	Rate	22	1			1	1		1													
2007/s/tz1/ p5/Q# 1/	8	Rate	15	1		Gas volume	1			1			1										
2007/w/tz1/ p5/Q# 2/	8	Rate	14	1		Gas volume	2	1							1		1						
2009/w/tz1/ p5/Q# 1/	8	Rate	15	1			1			1			1				1						
2017/w/tz1/ p5/Q# 1/	8	Rate	14	1			1				1						1		1		1		
2020/m/tz2/ p5/Q# 2/	8	Rate	11	1			2	1						1		1							
2021/s/tz1/ p5/Q# 1/	8	Rate	14	1		Gas volume	1		1					1						1	1		
2004/w/tz1/ p5/Q# 1/	26	Rate	20	1			1																
2011/w/tz1/ p5/Q# 2/	26	Rate	15	1			2	1			1				1						1		
2012/w/tz1/ p5/Q# 2/	26	Rate	15	1			2	1			1				1						1		
2016/m/tz2/ p5/Q# 1/	26	Rate	20	1	Titration		1			1				1									
2016/s/tz1/ p5/Q# 2/	26	Rate	15	1			2	1							1						1		
2016/w/tz1/ p5/Q# 2/	26	Rate	15	1			2	1							1								
2018/s/tz1/ p5/Q# 2/	26	Rate	18	1		Gas volume	2	1	1														
2018/w/tz1/ p5/Q# 1/	26	Rate	14	1			1												1		1		
2019/m/tz2/ p5/Q# 1/	26	Rate	20	1	Standard solution		1	1		1						1				1	1		
2021/w/tz1/ p5/Q# 2/	26	Rate	16	1		Gas volume	2	1	1					1	1								
2022/s/tz1/ p5/Q# 2/	26	Rate	16	1	Titration		2	1			1				1	1						1	
2022/w/tz1/ p5/Q# 3/	26	Rate	7	1	Standard solution		3			1													
2023/m/tz2/ p5/Q# 2/	26	Rate	15	1	Standard solution		2	1		1				1	1				1	1			
2023/s/tz2/ p5/Q# 3/	26	Rate	14	1	Standard solution	Gas volume	3	1		1					1								
2005/w/tz1/ p5/Q# 1/	4	Titration	20	2			1												1				

Question ID and locator	Topic #	Main experiment	# marks	Rank (last 10 years)	Additional experimental details	Additional experimental details	# Q	Graph	Apparatus			Results table: create	Calculation: describe	Prediction	Variables	Anomaly:	Accuracy	Precision	Error	%Error	Reliability	Health & safety	Improvement
									Draw & label	Set up (Method)	Name or describe												
2002/s/tz1/ p5/Q# 1/	6	Titration	19	2			1	1															
2003/s/tz1/ p5/Q# 1/	6	Titration	20	2			1																
2018/m/tz2/ p5/Q# 2/	6	Titration	14	2			2			1													
2020/m/tz2/ p5/Q# 1/	6	Titration	19	2			1			1						1				1			
2020/w/tz1/ p5/Q# 1/	6	Titration	13	2	Standard solution		1				1									1			
2021/m/tz2/ p5/Q# 2/	6	Titration	20	2	Standard solution		2				1	1											
2021/s/tz1/ p5/Q# 2/	6	Titration	16	2			2									1		1	1				
2014/w/tz1/ p5/Q# 2/	7	Titration	15	2	Standard solution		2								1			1	1				
2015/s/tz1/ p5/Q# 1/	7	Titration	15	2	Standard solution		1							1									
2023/m/tz2/ p5/Q# 1/	7	Titration	15	2			1			1										1			
2016/w/tz1/ p5/Q# 1/	10	Titration	15	2	Standard solution		1			1												1	
2013/s/tz1/ p5/Q# 1/	11	Titration	15	2			1			1			1									1	
2019/w/tz1/ p5/Q# 1/	24	Titration	13	2	Standard solution		1				1												
2023/s/tz2/ p5/Q# 1/	25	Titration	9	2	Partition coefficient, K _{pc}		1			1			1									1	
2004/s/tz1/ p5/Q# 2/	2	Gas volume	11	3			2		1							1							
2005/s/tz1/ p5/Q# 3/	2	Gas volume	10	3	Titration		3											1	1				
2012/s/tz1/ p5/Q# 2/	4	Gas volume	15	3			2	1				1			1						1		
2015/w/tz1/ p5/Q# 1/	4	Gas volume	15	3			1		1										1			1	
2022/w/tz1/ p5/Q# 2/	4	Gas volume	13	3			2	1	1					1	1					1	1	1	
2015/s/tz1/ p5/Q# 2/	7	Gas volume	15	3			2	1					1									1	
2020/s/tz1/ p5/Q# 2/	7	Gas volume	19	3			2	1	1		1					1							1
2016/s/tz1/ p5/Q# 1/	9	Gas volume	15	3	Titration		1		1													1	
2020/w/tz1/ p5/Q# 2/	14	Gas volume	17	3			2	1							1					1	1	1	1
2002/s/tz1/ p5/Q# 2/	27	Gas volume	9	3	Thermal Decomposition		2		1														1



Question ID and locator	Topic #	Main experiment	# marks	Rank (last 10 years)	Additional experimental details	Additional experimental details	# Q	Graph	Apparatus				Results table: create	Calculation: describe	Prediction	Variables	Anomaly:	Accuracy	Precision	Error	%Error	Reliability	Health & safety	Improvement
									Draw & label	Set up (Method)	Name or describe													
2009/s/tz1/ p5/Q# 1/	27	Gas volume	15	3	Thermal Decomposition		1		1					1								1		
2011/s/tz1/ p5/Q# 1/	27	Gas volume	16	3	Thermal Decomposition		1		1		1			1								1		
2014/s/tz1/ p5/Q# 1/	27	Gas volume	15	3	Thermal Decomposition		1		1									1				1		
2003/w/tz1/ p5/Q# 2/	2	States of matter	5	4			2			1		1												
2010/w/tz1/ p5/Q# 1/	2	States of matter	16	4			1			1		1			1									
2004/w/tz1/ p5/Q# 2/	4	States of matter	10	4			2	1		1		1												
2010/s/tz1/ p5/Q# 2/	4	States of matter	9	4			2	1								1								
2018/m/tz2/ p5/Q# 1/	4	States of matter	16	4			1	1	1							1	1	1						
2014/w/tz1/ p5/Q# 1/	9	States of matter	15	4			1			1								1	1					
2019/m/tz2/ p5/Q# 2/	10	States of matter	10	4			2		1										1					
2022/s/tz1/ p5/Q# 1/	11	States of matter	14	4	Standard solution		1	1			1						1				1	1	1	
2022/w/tz1/ p5/Q# 1/	11	States of matter	10	4			1			1											1			
2019/s/tz1/ p5/Q# 2/	21	States of matter	14	4			2		1														1	
2008/w/tz1/ p5/Q# 1/	23	States of matter	15	4			1			1		1	1		1								1	
2010/w/tz1/ p5/Q# 2/	23	States of matter	14	4			2	1				1		1		1								
2009/s/tz1/ p5/Q# 2/	27	States of matter	15	4			2	1				1				1		1						
2013/w/tz1/ p5/Q# 2/	27	States of matter	15	4			2	1						1		1					1			
2012/s/tz1/ p5/Q# 1/	28	States of matter	15	4			1			1					1								1	
2008/w/tz1/ p5/Q# 2/	24	Electrolysis	15	5			2	1				1				1		1						
2014/s/tz1/ p5/Q# 2/	24	Electrolysis	15	5			2	1								1								
2017/w/tz1/ p5/Q# 2/	24	Electrolysis	16	5			2	1											1	1				
2018/s/tz1/ p5/Q# 1/	24	Electrolysis	12	5			1		1												1		1	
2018/w/tz1/ p5/Q# 2/	24	Electrolysis	16	5	Solubility product, K _{sp}		2	1		1	1													
2019/s/tz1/ p5/Q# 1/	24	Electrolysis	16	5	Standard solution		1	1			1					1								

Question ID and locator	Topic #	Main experiment	# marks	Rank (last 10 years)	Additional experimental details	Additional experimental details	# Q	Apparatus				Results table: create	Calculation: describe	Prediction	Variables	Anomaly:	Accuracy	Precision	Error	%Error	Reliability	Health & safety	Improvement
								Graph	Draw & label	Set up (Method)	Name or describe												
2003/w/tz1/ p5/Q# 1/	5	Thermometric	25	6			1			1													
2004/s/tz1/ p5/Q# 1/	5	Thermometric	19	6			1	1															
2008/s/tz1/ p5/Q# 1/	5	Thermometric	15	6			1			1		1	1	1									1
2016/m/tz2/ p5/Q# 2/	5	Thermometric	10	6			2	1												1			
2017/s/tz1/ p5/Q# 1/	5	Thermometric	12	6			1	1	1					1	1								
2020/s/tz1/ p5/Q# 1/	5	Thermometric	11	6			1			1			1						1			1	1
2021/m/tz2/ p5/Q# 1/	5	Thermometric	10	6			1	1	1										1				
2007/w/tz1/ p5/Q# 1/	23	Thermometric	15	6			1		1	1		1		1	1							1	
2011/w/tz1/ p5/Q# 1/	23	Thermometric	15	6			1			1		1											
2013/w/tz1/ p5/Q# 1/	23	Thermometric	15	6			1		1					1									
2021/w/tz1/ p5/Q# 1/	27	Thermometric	14	6	Thermal Decomposition		1			1										1			1
2017/s/tz1/ p5/Q# 2/	2	Miscellaneous	18	7	Standard solution	Optical rotation	2	1			1				1				1				
2022/m/tz2/ p5/Q# 2/	25	Miscellaneous	21	7	Standard solution	Conductivity	2	1							1					1	1		1
2017/m/tz2/ p5/Q# 2/	28	Miscellaneous	12	7	Standard solution	Colourimetry	2	1			1												1
2023/s/tz2/ p5/Q# 2/	37	Miscellaneous	7	7		Chromatography	2			1													1
2002/w/tz1/ p5/Q# 2/	2	Gravimetric	9	8	Mass lost		2			1		1											
2003/s/tz1/ p5/Q# 2/	2	Gravimetric	10	8	Mass lost	Gas volume, Titration,	2					1	1										
2005/s/tz1/ p5/Q# 1/	2	Gravimetric	8	8	Mass lost		1																
2008/s/tz1/ p5/Q# 2/	2	Gravimetric	15	8	Mass lost	Gas volume	2	1				1			1			1					1
2009/w/tz1/ p5/Q# 2/	2	Gravimetric	15	8			2					1			1				1				
2010/s/tz1/ p5/Q# 3/	2	Gravimetric	6	8	Mass gained		3								1				1				
2013/s/tz1/ p5/Q# 2/	2	Gravimetric	15	8	Mass lost		2	1							1							1	
2022/m/tz2/ p5/Q# 1/	2	Gravimetric	9	8	Mass lost		1			1	1									1			
2017/m/tz2/ p5/Q# 1/	5	Gravimetric	18	8	Mass lost	Thermal decomposition	1	1		1				1						1			
2006/s/tz1/ p5/Q# 2/	6	Gravimetric	8	8	Mass lost	Gas volume	2			1													1

Question ID and locator	Topic #	Main experiment	# marks	Rank (last 10 years)	Additional experimental details	Additional experimental details	# Q	Apparatus				Results table: create	Calculation: describe	Prediction	Variables	Anomaly:	Accuracy	Precision	Error	%Error	Reliability	Health & safety	Improvement
								Graph	Draw & label	Set up (Method)	Name or describe												
2007/s/tz1/ p5/Q# 2/	6	Gravimetric	15	8	Mass lost		2	1							1					1			
2012/w/tz1/ p5/Q# 1/	6	Gravimetric	15	8	Mass lost		1		1		1	1		1								1	
2006/w/tz1/ p5/Q# 2/	27	Gravimetric	10	8	Mass lost		2			1													
2011/s/tz1/ p5/Q# 2/	27	Gravimetric	14	8	Mass lost	Thermal decomposition	2	1			1				1								
2005/s/tz1/ p5/Q# 2/	2	Thermometric titration	12	9			2	1															
2010/s/tz1/ p5/Q# 1/	5	Thermometric titration	15	9			1				1		1	1		1						1	
2005/w/tz1/ p5/Q# 2/	7	Thermometric titration	10	9			2				1												
2006/w/tz1/ p5/Q# 1/	7	Thermometric titration	20	9			1	1															
2015/w/tz1/ p5/Q# 2/	7	Thermometric titration	15	9			2	1					1					1	1				
Totals			1527					47	22	33	14	26	4	12	21	30	10	9	17	21	12	27	7



CAIE A Level Chemistry 9701 Paper 5: Planning, Analysis and Evaluation

Percentage of all marks awarded for each Experiment Type from w2022 to s2002, Timezone 1 for summer and winter only (51 exam papers in total)

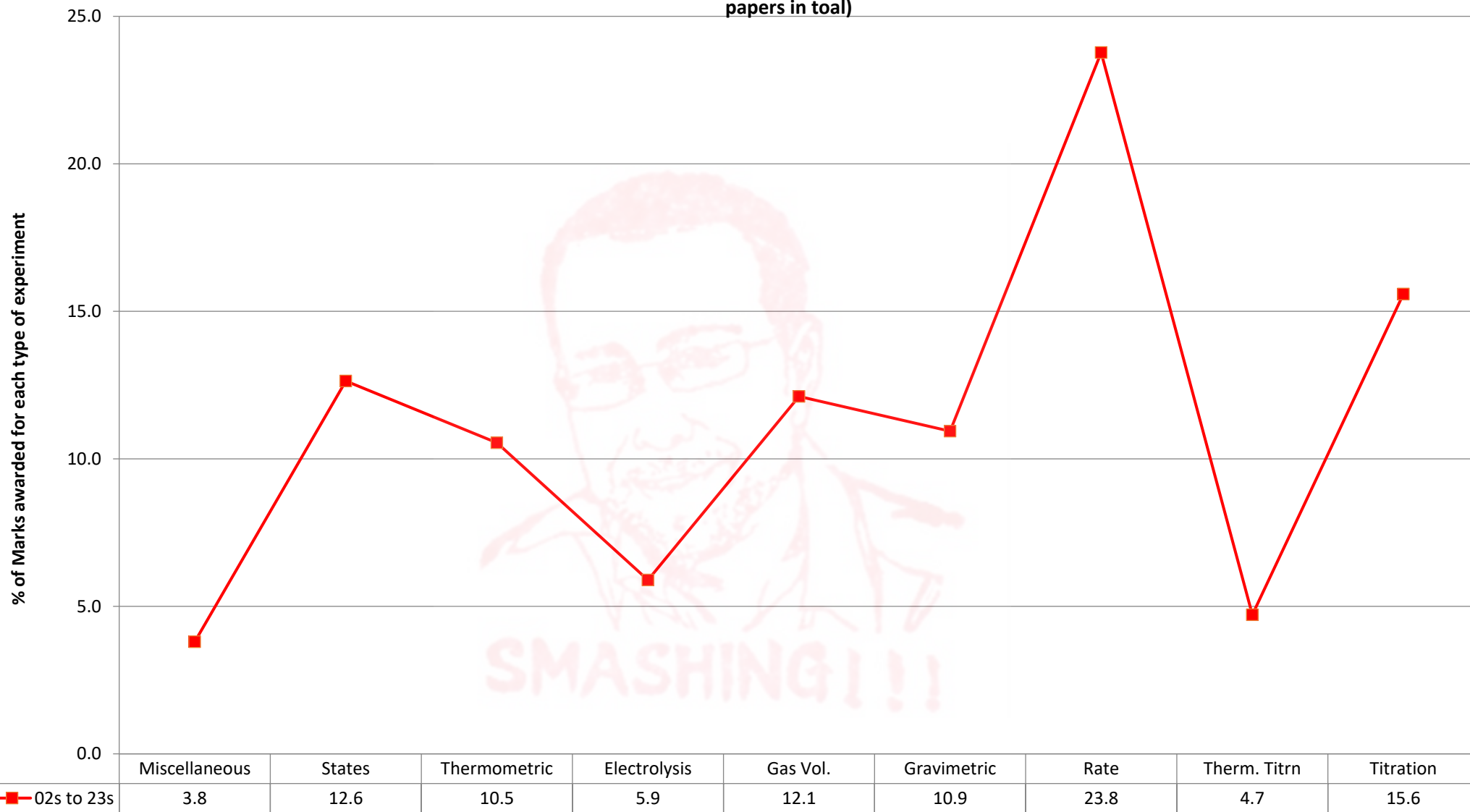

Paper 5 Experiment type



CAIE A Level Chemistry 9701 **Paper 5: Planning, Analysis and Evaluation**
 Percentage of all marks awarded for each Experiment Type from w2022 to s2002, Timezone 1 for summer
 and winter only (51 exam papers in total)

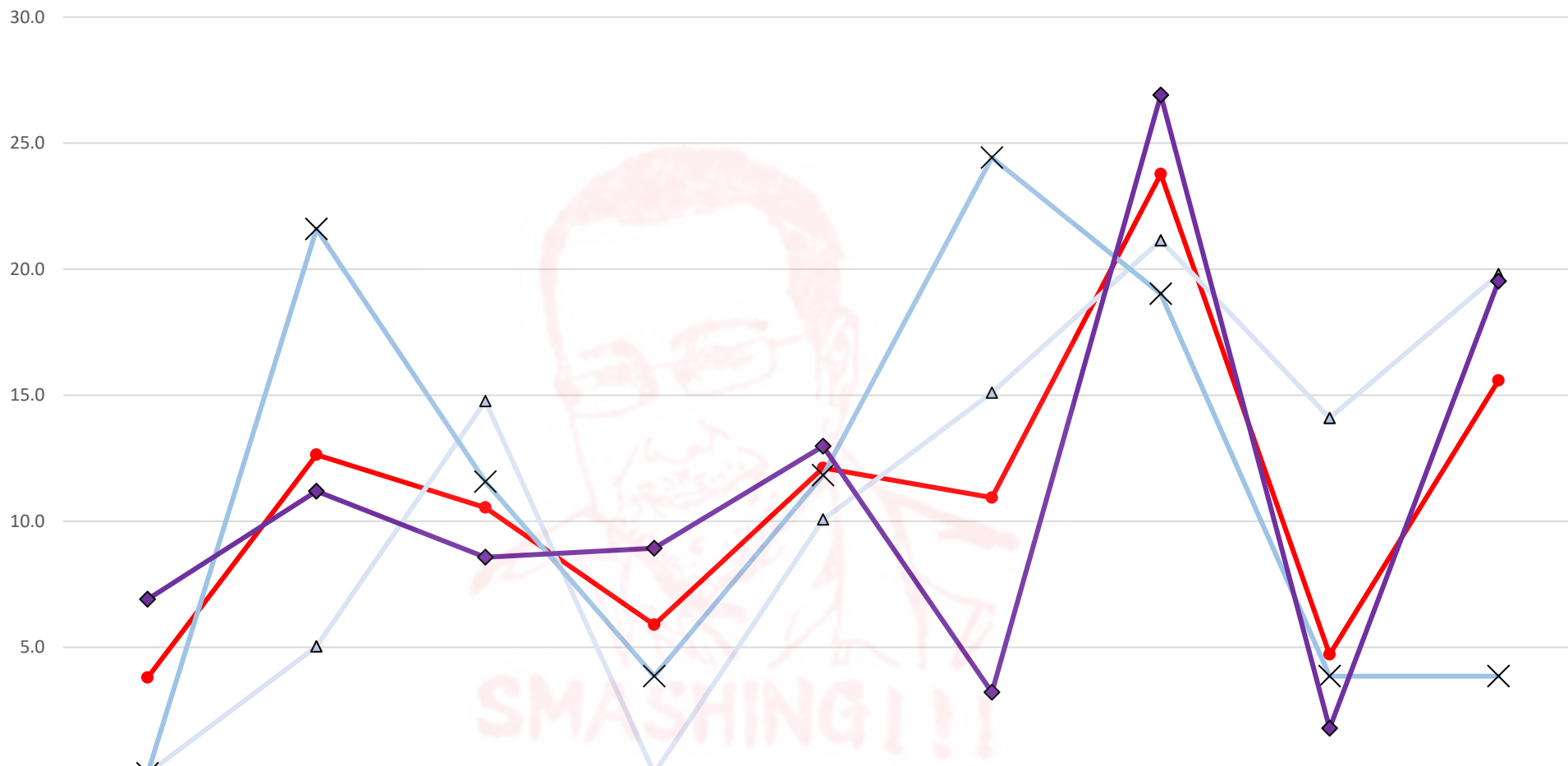

	Miscellaneous	States	Thermometric	Electrolysis	Gas Vol.	Gravimetric	Rate	Therm. Titrn	Titration
02s to 23s	3.8	12.6	10.5	5.9	12.1	10.9	23.8	4.7	15.6
02s-06w	0.0	5.0	14.8	0.0	10.1	15.1	21.1	14.1	19.8
07s-13s	0.0	21.6	11.6	3.9	11.8	24.4	19.0	3.9	3.9
13w-23s	6.9	11.2	8.6	8.9	13.0	3.2	26.9	1.8	19.5

02s to 23s 02s-06w 07s-13s 13w-23s



CAIE A Level Chemistry 9701 Paper 5: Planning, Analysis and Evaluation

Percentage of all marks awarded for each topic from w2022 to s2002, Timezone 1 for summer and winter only (51 exam papers in total)

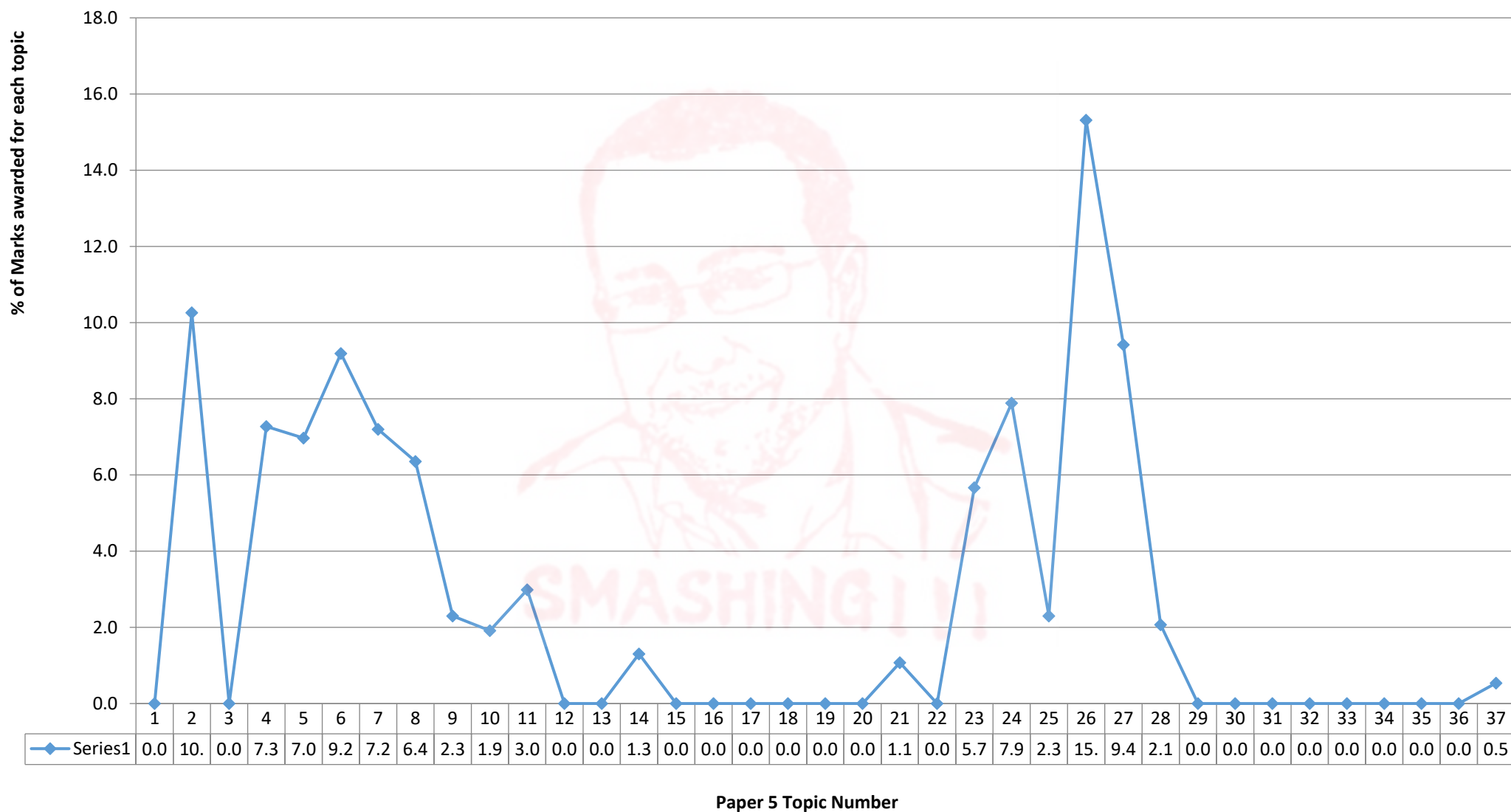

CAIE A Level Chemistry 9701 **Paper 5**: Planning, Analysis and Evaluation

Percentage of all marks awarded for each Topic Number from w2022 to s2002, Timezone 1 for summer and winter only (51 exam papers in total)

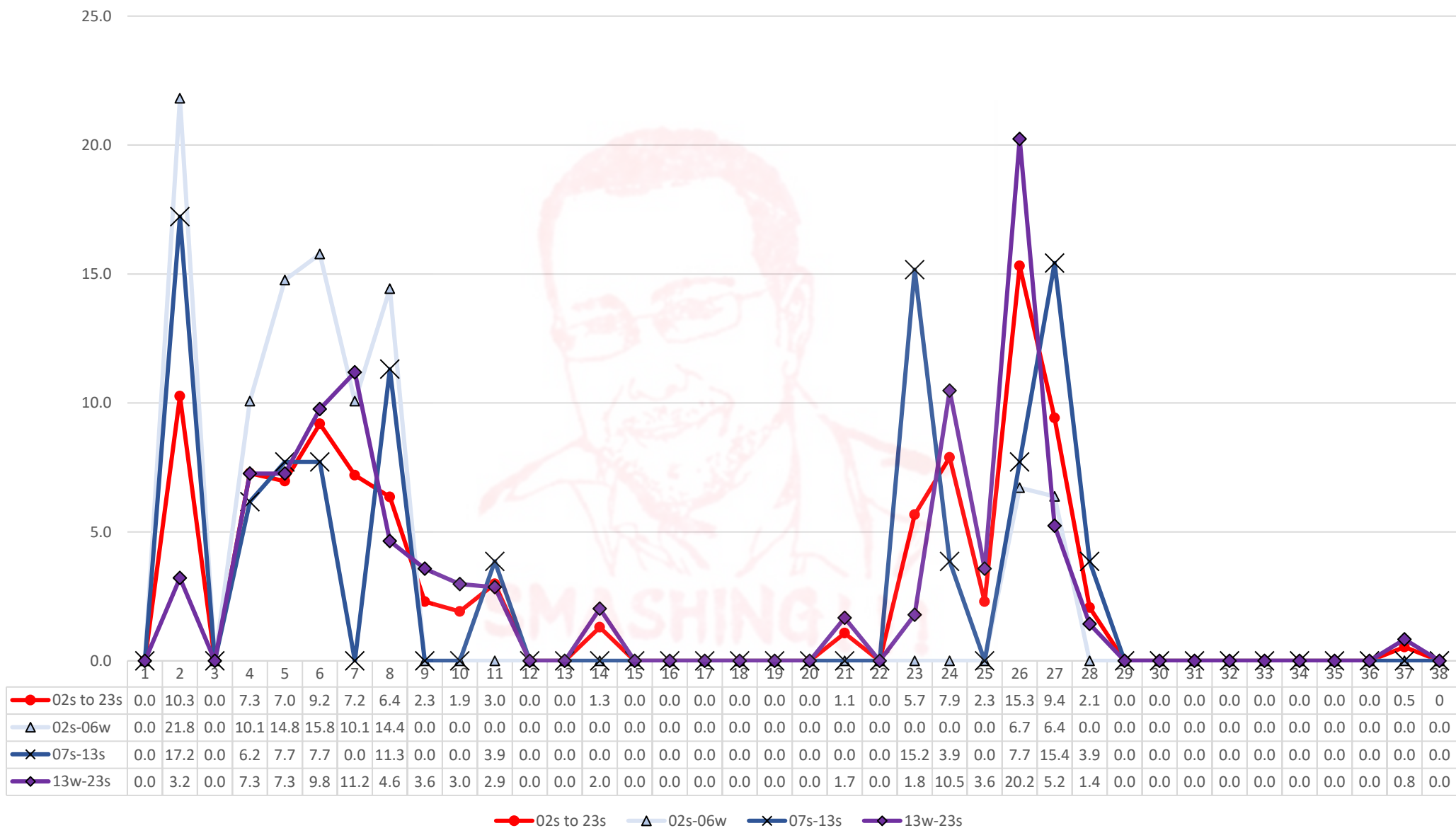

CAIE A Level Chemistry 9701 Paper 5: Planning, Analysis and Evaluation - SIMPLIFIED

Percentage of all marks awarded for each Topic Number from w2022 to s2002, Timezone 1 for summer and winter only (51 exam papers in total)

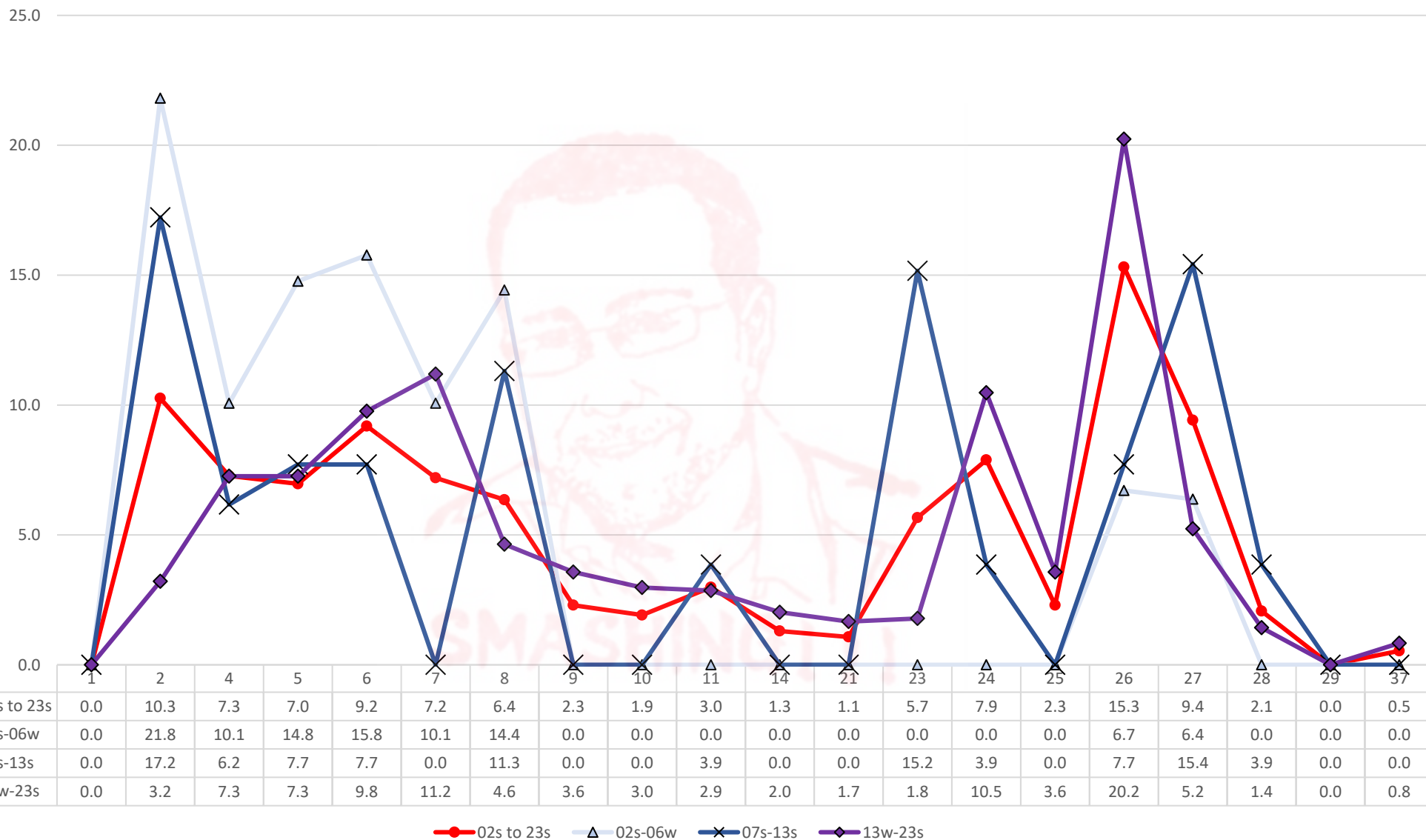

Paper 5 Planning, Analysis and Evaluation

Paper 5 is a timetabled, written paper focusing on the higher-order experimental skills of:

- planning
- analysis
- drawing conclusions
- evaluation.

This exam will not require laboratory facilities.

It should be emphasised that candidates cannot be adequately prepared for this exam without extensive laboratory work of A Level standard during their course of study. This requires many hours of laboratory-based work with careful supervision from teachers to ensure that experiments are planned and carried out safely.

Paper 5 consists of two or more questions totalling 30 marks.

Candidates may be required to design an experimental investigation of a given problem. Such questions may not be highly structured: candidates may be expected to answer using extended, structured writing illustrated with appropriate diagrams, flow charts, tables or equations.

Candidates may be asked to express a prediction in the form of a written hypothesis linking independent and dependent variables, or in the form of a graph showing the expected outcome.

There may be questions in which candidates are given experimental data and are required to analyse, evaluate and draw conclusions from this.

Some questions may be set in areas of chemistry that are difficult to investigate experimentally in school laboratories, possibly for reasons of cost or safety. No question will require knowledge of theory or equipment that is beyond that expected of A Level practical work in the syllabus. Information that candidates are not expected to know will be provided in the examination paper.

Mark allocations for Paper 5

Marks will be allocated for Paper 5 according to the table below. The expectations for each skill are listed in the sections that follow.

Skill	Breakdown of skills	Minimum mark allocation*
Planning	Defining the problem	12 marks
	Method	
Analysis, conclusion and evaluation	Dealing with data	12 marks
	Conclusion	
	Evaluation	

* The remaining 6 marks will be allocated across the skills in this grid and their allocation may vary from paper to paper.

Expectations for each skill (Paper 5)

Candidates will be provided with information about the aims of an experiment, and some background information relating to it.

Planning

Defining the problem

Candidates should be able to:

- identify a safe and efficient procedure that when followed would lead to a reliable result
- identify the steps necessary to carry out the procedure
- identify apparatus that is suitable for carrying out each step of the procedure
- show an understanding of the risks of a proposed experiment
- identify the independent variable in an experiment
- identify the dependent variable in an experiment
- express the aim of an experiment in terms of a prediction, and express this in words or in the form of a predicted graph
- identify any variables that are to be controlled
- show an understanding of how and why the procedure suggested will be effective.

Method

Candidates should be able to:

- describe the method to be used when carrying out the experiment to its full conclusion, including, as appropriate, preparation of results tables, proposed graphs to plot, key points to consider in any evaluation of the method and results, and reference back to the prediction
- describe the arrangement of apparatus, by use of words or labelled diagrams, and the steps in the procedure to be followed in order to collect all relevant data
- suggest the use of appropriate measuring instruments so that the data are recorded to a suitable precision
- suggest appropriate volumes and concentrations of reagents
- describe precautions that should be taken to keep risks to a minimum; these include use of a fume hood for hazardous gases, use of a face mask for hazardous particles, avoidance of naked flames for flammable materials and wearing chemically resistant gloves for handling irritant materials
- describe how to vary the independent variable and how the dependent variable is to be measured, and describe how each of the other key variables might be controlled
- explain how any control experiments might be used to verify that it is the independent variable that is affecting the dependent variable and not some other factor
- describe the outcome of steps in the procedure where these are relevant to the overall experiment
- draw up appropriately headed tables for data to be recorded and describe how the data might be used in order to reach a conclusion
- describe standard laboratory practice when carrying out quantitative determinations, e.g. making up of standard solutions, weighing by difference, concordancy of titrations, heating to constant mass, taking more readings about the inflexion point of a plot of data values.

Analysis, conclusions and evaluation

Dealing with data

Candidates should be able to:

- identify the calculations and means of presentation of data that are necessary to be able to draw conclusions from provided data
- use calculations to enable simplification or explanation of data, including calculation of mean, percentage and percentage gain or loss
- use tables and graphs to draw attention to the key points in quantitative data, including the variability of data
- analyse data to draw appropriate conclusions
- plot an appropriate graph from provided or calculated data fulfilling the criteria for plotting detailed in the Paper 3 section on page 55.
- plot a graph of y against x and use the graph to find the values of m and c in an equation of the form $y = mx + c$
- suggest appropriate axes from a range of data values
- calculate the percentage error of a measurement
- calculate quantities from raw data
- use the correct number of significant figures for these calculated quantities.

Conclusion

Candidates should be able to:

- draw a conclusion from an investigation, providing a detailed description of the key features of the data and analyses, and considering whether experimental data support the conclusion reached
- make detailed scientific explanations of the data, analyses and conclusion described
- make further predictions and suggest improvements
- conclude whether errors in experimentally obtained data could be accounted for by a measurement error or by other factors.

Evaluation

Candidates should be able to:

- identify anomalous values in provided data, suggest possible explanations for anomalous readings and suggest appropriate means of dealing with such anomalies
- identify the extent to which provided readings have been adequately replicated and the benefit of this
- describe the adequacy of the range of data provided
- use provided information to assess the extent to which selected variables have been effectively controlled
- identify and explain the weaknesses of the experimental procedure used
- suggest and explain the effect that a change in the concentrations of reagents or the conditions used for the experiment might have on the results obtained
- suggest the consequences that the incorrect use of apparatus might have on the results obtained
- explain that data that obey a line of best fit are reliable because there are no anomalous points
- comment on the validity of data with regards to their suitability to prove or disprove a prediction
- identify instances where additional readings being taken during the experiment would be advantageous in order to give a more comprehensive range of values
- draw together all available information to make judgements about the reliability of the investigation and the trustworthiness of its outcomes
- comment on the quality of data and state whether or not the data support a prediction
- use evaluations and provided information to make informed judgements on the confidence with which conclusions may be drawn.

Apparatus and materials

This section gives guidance to schools concerning the apparatus and materials that are expected to be available within the centre for use during practical exams. The lists are not intended to be exhaustive. Unless otherwise stated, for apparatus the number given is 'per candidate'. Centres should keep these apparatus and materials in stock and candidates should be accustomed to using them.

Apparatus

Glassware should, where possible, conform to the quality specifications given, or supervisors should otherwise satisfy themselves that the glassware used is of an appropriate accuracy.

- 1 × 10 cm³ pipette (ISO648 or grade B)
- 1 × 25 cm³ pipette (ISO648 or grade B)
- 1 × pipette filler
- 2 × 50 cm³ burette (ISO385 or grade B)
- 2 × 150 cm³ or 250 cm³ conical flask
- 1 × 25 cm³ measuring cylinder (ISO6706 or ISO4788 or grade B)
- 1 × 50 cm³ measuring cylinder (ISO6706 or ISO4788 or grade B)
- 1 × 250 cm³ plastic or glass measuring cylinder
- 2 × burette stand and clamp
- 1 × 250 cm³ one-mark graduated volumetric flask (ISO1042 or grade B)
- 2 × 100 cm³ beaker, squat form with lip
- 2 × 250 cm³ beaker, squat form with lip
- 1 × funnel (for filling burette)
- 1 × white tile
- 1 × stand and clamp
- 1 × tub suitable for acting as trough (minimum capacity 1 dm³)
- 1 × side-arm conical flask with bung connected to approximately 50 cm of plastic/rubber delivery tube OR additional 150 cm³ or 250 cm³ conical flask with one-hole bung connected to approximately 50 cm of plastic/rubber delivery tube
- 1 × thermometer (-10 °C to +110 °C at 1 °C)
- 2 × plastic or cardboard cup, capacity approximately 150 cm³
- 1 × glass rod
- 1 × stop-clock to measure to an accuracy of 1 second
- 2 × teat/dropping pipette
- 1 × spatula
- 2 × crucible with lid (approximate capacity 15 cm³)
- 1 × crucible tongs
- 1 × pipe-clay triangle
- 1 × tripod
- 1 × gauze
- 1 × Bunsen burner (propane or butane burners are suitable, spirit burners are not recommended)
- 1 × heat-proof mat
- 1 × test-tube holder
- 2 × boiling tube, approximately 150 mm × 25 mm
- 2 × hard-glass test-tube
- 8 × test-tube, approximately 125 mm × 16 mm
- 1 × test-tube rack
- balance, single-pan, direct reading, minimum accuracy 0.01g (1 per 8 –12 candidates) weighing to 200 g
- 1 × wash bottle
- 1 × pen for labelling glassware
- red and blue litmus papers
- aluminium foil
- wooden splints

Plan Marks

Marks for the Plan (a-d) may be awarded from the Table(s) of Results or from the Processing of Results

Processing of Results Marks

Marks in the final section (e-g) may be found in and awarded from the Planning Section

Marks for the Table of Results

The three marks in this section can only be awarded in the Table of Results Section

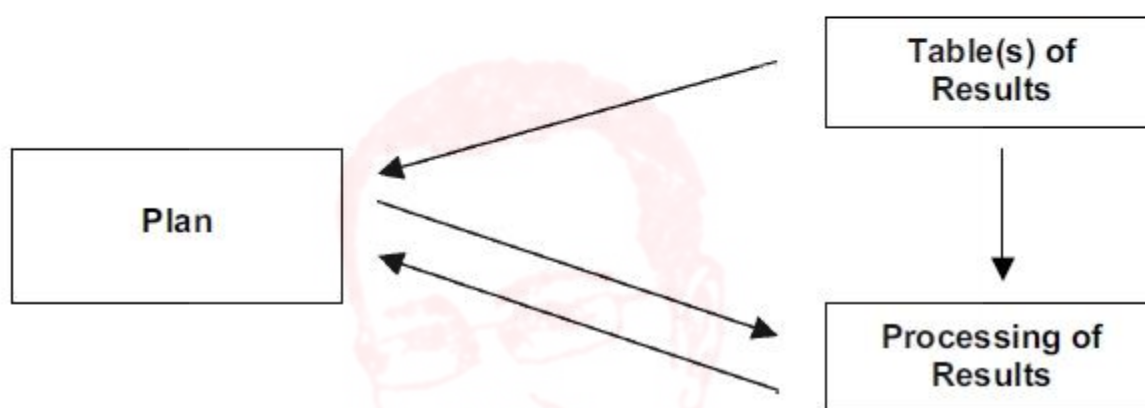

Total for Question 2 **10**

Total for Paper **30**

Page 2	Mark Scheme	Syllabus	Paper
	GCE A/AS LEVEL – October/November 2008	9701	05

Skill		Breakdown of marks	
Planning	15 marks	Defining the problem	5 marks
		Methods	10 marks
Analysis, conclusions and evaluation	15 marks	Dealing with data	8 marks
		Evaluation	4 marks
		Conclusion	3 marks

Statement Bank

PLANNING (PLAN)

Defining the problem (problem)

P1	identify the independent variable in the experiment or investigation
P2	identify the dependent variable in the experiment or investigation
P3	express the aim in terms of a prediction or hypothesis, and express this in words or in the form of a predicted graph
P4	identify the variables that are to be controlled

Methods (methods)

M1	describe the method to be used to vary the independent variable, and the means that they will propose to ensure that they have measured its value accurately
M2	describe how the dependent variable is to be measured
M3	describe how each of the other key variables is to be controlled
M4	explain how any control experiments will be used to verify that is the independent variable that is affecting the dependent variable and not some other factor
M5	describe the arrangement of apparatus and the steps in the procedure to be followed
M6	suggest appropriate volumes and concentrations of reagents
M7	assess the risks in their proposed methods
M8	describe precautions that should be taken to keep risks to a minimum
M9	draw up tables for data that they might wish to record
M10	describe how the data might be used in order to reach a conclusion

ANALYSIS, CONCLUSIONS AND EVALUATION (ACE)

Dealing with data (data)

D1	identify the calculations and means of presentation of data that are necessary to be able to draw conclusions from provided data
D2	use calculations to enable simplification or explanation of data
D3	use tables and graphs to draw attention to the key points in quantitative data, including the variability of data

Evaluation (evaluation)

E1	identify anomalous values in provided data and suggest appropriate means of dealing with such anomalies within familiar contexts, suggest possible explanations for anomalous readings
E2	within familiar contexts, suggest possible explanations for anomalous readings
E3	identify the extent to which provided readings have been adequately replicated, and describe the adequacy of the range of data provided
E4	use provided information to assess the extent to which selected variables have been effectively controlled
E5	use these evaluations and provided information to make informed judgements on the confidence with which conclusions may be drawn

Conclusions (conclusions)

C1	draw conclusions from an investigation, providing a detailed description of the key features of the data and analyses, and considering whether experimental data supports a given hypothesis
C2	make detailed scientific explanations of the data, analysis and conclusions that they have described
C3	make further predictions, ask informed and relevant questions and suggest improvements

Skill	Total marks	Breakdown of marks			Question 1	Question 2
			Statement	Marks		
Planning	15 marks	Defining the <u>problem</u>	P	5	5	0
		<u>Methods</u>	M	10	10	0
Analysis, conclusions and evaluation	15 marks	Dealing with <u>data</u>	D	8	0	8
		<u>Evaluation</u>	E	4	0	4
		<u>Conclusion</u>	C	3	0	3

ALvl Chemistry/2020/m/TZ 2/ Paper 5/Q# 1/www.SmashingScience.org

Science-Specific Marking Principles

1	Examiners should consider the context and scientific use of any keywords when awarding marks. Although keywords may be present, marks should not be awarded if the keywords are used incorrectly.
2	The examiner should not choose between contradictory statements given in the same question part, and credit should not be awarded for any correct statement that is contradicted within the same question part. Wrong science that is irrelevant to the question should be ignored.
3	Although spellings do not have to be correct, spellings of syllabus terms must allow for clear and unambiguous separation from other syllabus terms with which they may be confused (e.g. ethane / ethene, glucagon / glycogen, refraction / reflection).
4	The error carried forward (ecf) principle should be applied, where appropriate. If an incorrect answer is subsequently used in a scientifically correct way, the candidate should be awarded these subsequent marking points. Further guidance will be included in the mark scheme where necessary and any exceptions to this general principle will be noted.

5 'List rule' guidance (see examples below)

For questions that require n responses (e.g. State two reasons ...):

- The response should be read as continuous prose, even when numbered answer spaces are provided
- Any response marked *ignore* in the mark scheme should not count towards n
- Incorrect responses should not be awarded credit but will still count towards n
- Read the entire response to check for any responses that contradict those that would otherwise be credited. Credit should not be awarded for any responses that are contradicted within the rest of the response. Where two responses contradict one another, this should be treated as a single incorrect response
- Non-contradictory responses after the first n responses may be ignored even if they include incorrect science.

6 Calculation specific guidance

Correct answers to calculations should be given full credit even if there is no working or incorrect working, unless the question states 'show your working'.

For questions in which the number of significant figures required is not stated, credit should be awarded for correct answers when rounded by the examiner to the number of significant figures given in the mark scheme. This may not apply to measured values.

For answers given in standard form, (e.g. $a \times 10^n$) in which the convention of restricting the value of the coefficient (a) to a value between 1 and 10 is not followed, credit may still be awarded if the answer can be converted to the answer given in the mark scheme.

Unless a separate mark is given for a unit, a missing or incorrect unit will normally mean that the final calculation mark is not awarded. Exceptions to this general principle will be noted in the mark scheme.

7 Guidance for chemical equations

Multiples / fractions of coefficients used in chemical equations are acceptable unless stated otherwise in the mark scheme.

State symbols given in an equation should be ignored unless asked for in the question or stated otherwise in the mark scheme.

Examples of how to apply the list rule

State three reasons.... [3]

A	1. Correct	✓	2
	2. Correct	✓	
	3. Wrong	✗	
B (4 responses)	1. Correct, Correct	✓, ✓	3
	2. Correct	✓	
	3. Wrong	ignore	
C (4 responses)	1. Correct	✓	2
	2. Correct, Wrong	✓, ✗	
	3. Correct	ignore	
D (4 responses)	1. Correct	✓	2
	2. Correct, CON (of 2.)	✗, (discount 2)	
	3. Correct	✓	
E (4 responses)	1. Correct	✓	3
	2. Correct	✓	
	3. Correct, Wrong	✓	

F (4 responses)	1. Correct	✓	2
	2. Correct	✓	
	3. Correct CON (of 3.)	✗ (discount 3)	
G (5 responses)	1. Correct	✓	3
	2. Correct	✓	
	3. Correct Correct CON (of 4.)	✓ ignore ignore	
H (4 responses)	1. Correct	✓	2
	2. Correct	✗	
	3. CON (of 2.) Correct	(discount 2) ✓	
I (4 responses)	1. Correct	✓	2
	2. Correct	✗	
	3. Correct CON (of 2.)	✓ (discount 2)	

Rate experiment

Topic Chem 4 Q# 1/ ALvl Chemistry/2019/w/TZ 1/ Paper 5/Q# 2/www.SmashingScience.org

2 The viscosity of a substance is a measure of how quickly the substance flows when it is subjected to a force such as gravity. The viscosity of a liquid or solution is dependent on:

- size of molecules
- strength of intermolecular forces of attraction
- temperature.

It is possible to calculate the mean molecular mass (mean M_r) of a polymer in solution by measuring the viscosity of solutions of the polymer at different concentrations.

Measurements related to the viscosity of a solution can be made using a capillary viscometer, shown in the diagram.

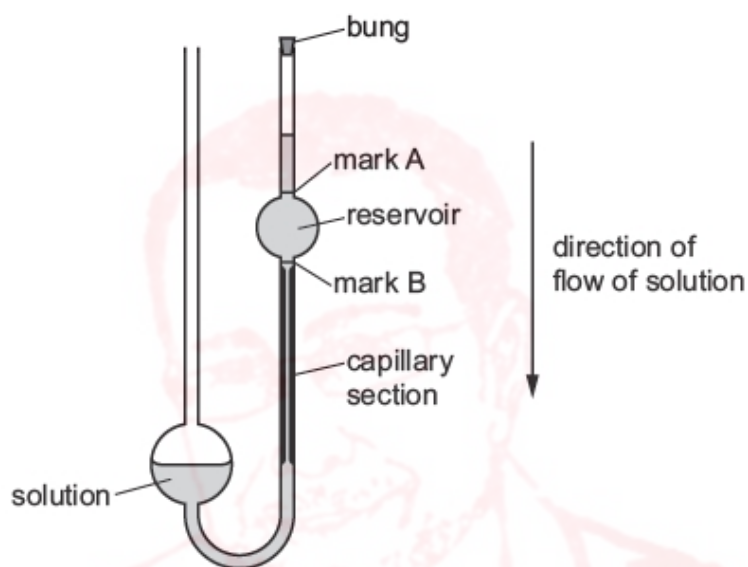

- The apparatus is set up as shown.
- The bung is removed and the solution falls through the capillary section.
- The time taken for the top of the solution to pass between the two marks at the top (A) and bottom (B) of the reservoir is recorded.
- This time taken is related to the viscosity of the solution.

A student plans an experiment to calculate the mean M_r of molecules of poly(phenylethene). The student plans to make solutions of different concentrations of poly(phenylethene) dissolved in methylbenzene, $C_6H_5CH_3$, an organic solvent.

(a) Before the experiment, a mixture of concentrated nitric acid and concentrated hydrochloric acid is passed through the capillary viscometer. The capillary viscometer is then rinsed, first with water, and then with propanone.

Suggest why the capillary viscometer is rinsed with water and then with propanone.

rinse with water

.....

rinse with propanone

.....

(b) A constant, η , related to the viscosity of a solution can be found by plotting a graph of $\left(\frac{1}{c}\right)\log\left(\frac{t}{t_0}\right)$ on the vertical axis against c on the horizontal axis.

c = concentration of poly(phenylethene) in $\text{C}_6\text{H}_5\text{CH}_3$ (in g dm^{-3})

t = time taken for the solution to pass between marks A and B (in s)

t_0 = time taken for pure $\text{C}_6\text{H}_5\text{CH}_3$ to pass between marks A and B (in s)

The results of a series of experiments using different concentrations of poly(phenylethene) in $\text{C}_6\text{H}_5\text{CH}_3$ are shown. The values of $\frac{t}{t_0}$ have been calculated for you.

Process the results to complete the table.

Record all your data to **three** significant figures.

concentration of poly(phenylethene), c / g dm^{-3}	$\frac{1}{c}$ / $\text{dm}^3 \text{g}^{-1}$	time taken, t / s	$\frac{t}{t_0}$	$\log\left(\frac{t}{t_0}\right)$	$\left(\frac{1}{c}\right)\log\left(\frac{t}{t_0}\right)$ / $\text{dm}^3 \text{g}^{-1}$
16.0		176	2.26		
14.0		164	2.10		
12.0		151	1.94		
10.0		138	1.77		
8.0		125	1.60		
6.0		113	1.45		
4.0		102	1.31		
2.0		89	1.14		

[3]

(c) Plot a graph on the grid to show the relationship between $\left(\frac{1}{c}\right)\log\left(\frac{t}{t_0}\right)$ and c .

Use a cross (x) to plot each data point. Draw the straight line of best fit.

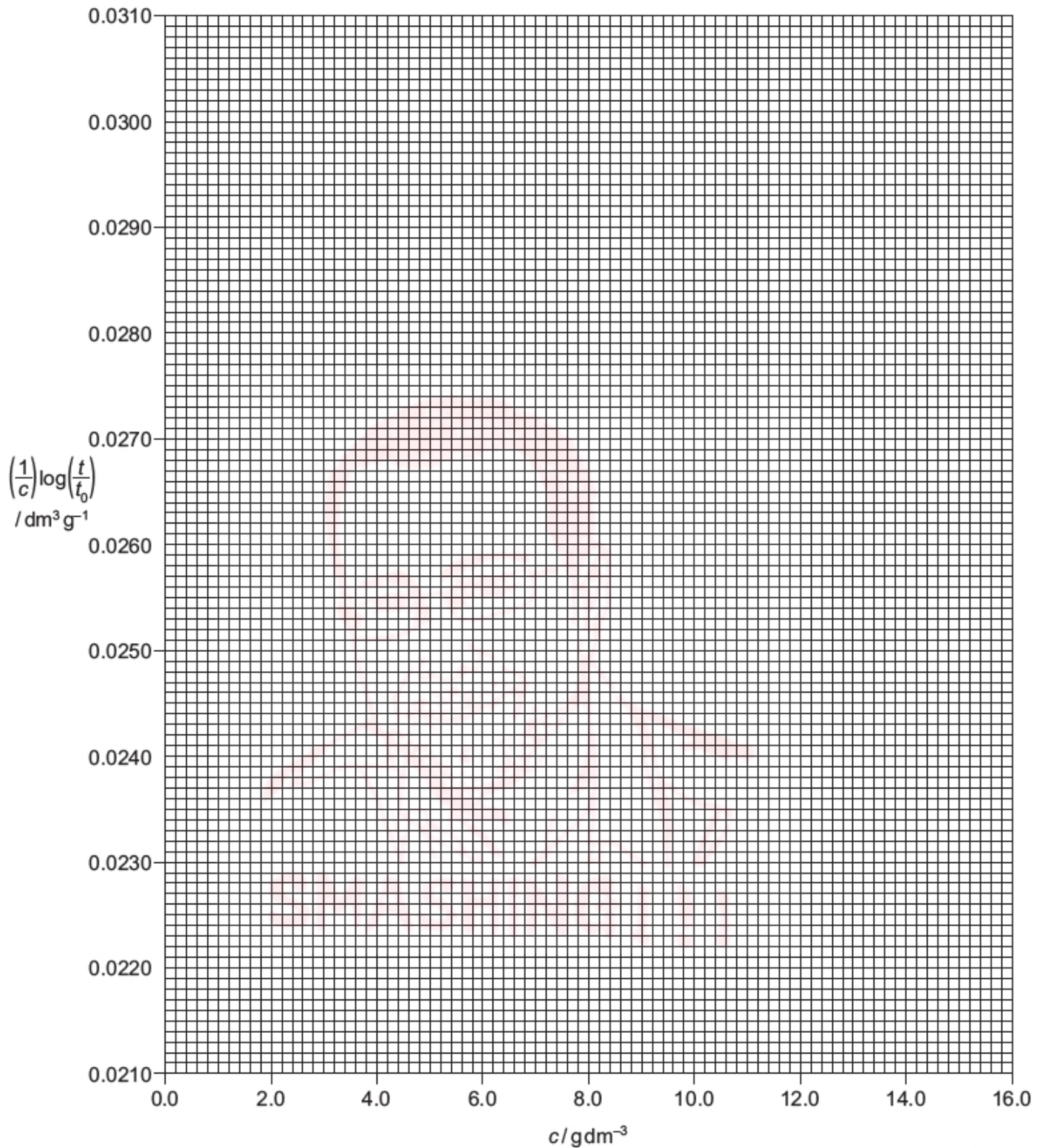

[2]

(d) (i) Capillary viscometer measurements are usually made at 25 °C.

Predict the effect on the time taken for the solution to fall between marks A and B if a solution of temperature 18 °C is tested in the viscometer.

Explain your answer.

.....

.....

.....

..... [2]

(ii) Suggest how a student could ensure that a measurement is made at 25 °C.

.....

..... [1]

(e) The data you have plotted shows an anomaly that comes from the results obtained.

Circle the anomalous point on the graph.

Suggest a reason for this anomaly. Assume that for this result, the concentration of the solution was correct.

.....

.....

..... [1]

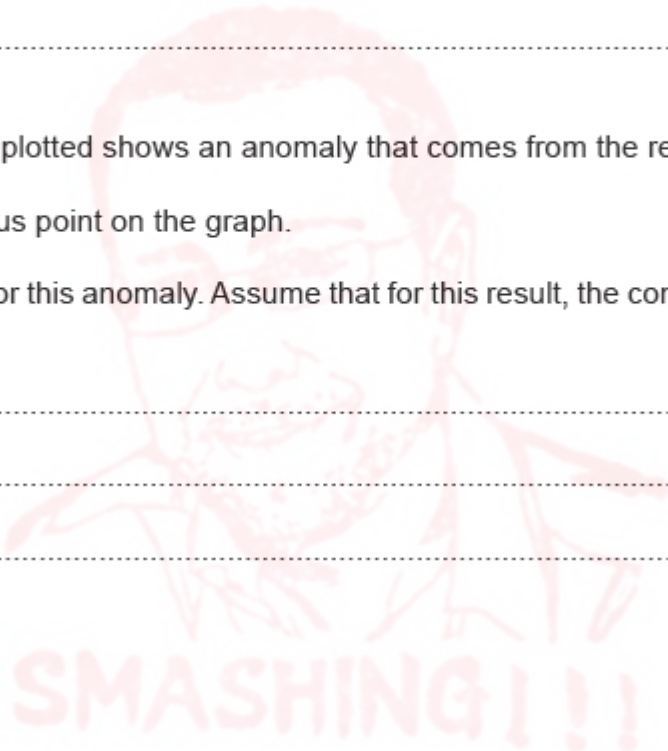

(f) The y-axis intercept on the graph in (c) is equal to $\frac{\eta}{2.30}$, where η is a constant for poly(phenylethene) at 25 °C.

(i) Use the graph you plotted in (c) to find a value for η .

$$\eta = \dots\dots\dots \text{ dm}^3\text{g}^{-1} \quad [1]$$

The relationship between η and the mean M_r is shown.
(K and a have specific values for solutions of poly(phenylethene).)

$$\eta = K \times (\text{mean } M_r)^a$$

For a solution of poly(phenylethene) dissolved in $\text{C}_6\text{H}_5\text{CH}_3$ the relationship can be expressed as shown.

$$\log(\text{mean } M_r) = 1.59 \log \eta + 7.03$$

(ii) Use your value of η calculated in (f)(i) to calculate a value for the mean M_r of poly(phenylethene) in this experiment.

$$\text{mean } M_r = \dots\dots\dots \quad [2]$$

(iii) Poly(phenylethene) forms when molecules of phenylethene, $\text{CH}_2\text{CHC}_6\text{H}_5$, undergo addition polymerisation.

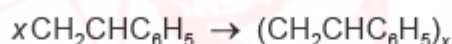

Use the value of mean M_r you calculated in (f)(ii) to calculate a value for x , the number of repeat units in the polymer.

Your answer should give the nearest whole-number value of x .

If you were unable to calculate a value in (f)(ii), then you may use mean $M_r = 1.56 \times 10^5$, but this may not be the correct answer.

[A_r : C, 12.0; H, 1.0]

$$x = \dots\dots\dots$$

[1]



- (g) In the equation, $\eta = K \times (\text{mean } M_r)^a$, a depends on the strength of the intermolecular forces between the solvent and the solute.

The value of a increases as the intermolecular forces between solvent and solute increase.

Predict how the value of a for poly(ethanol) dissolved in water differs from a for poly(phenylethene) dissolved in $\text{C}_6\text{H}_5\text{CH}_3$.

Explain your answer.

.....

.....

.....

..... [2]

[Total: 17]



EXPERIMENT Required, no longer needed from 2007 onwards.

1 You are to investigate the reaction between substance **X**, iodine and hydrogen ions.

FA 1 is 1.00 mol dm^{-3} sulphuric acid.

FA 2 is an aqueous solution of substance **X**.

FA 3 is $0.0038 \text{ mol dm}^{-3}$ iodine, I_2 .

Fill a burette with solution **FA 3**.

(a) Using the measuring cylinder provided, measure out 20.0 cm^3 of **FA 1** and 20.0 cm^3 of **FA 2**, as shown in column 1 of *Table 1.1*, into a 250 cm^3 conical flask. It is not necessary to rinse the measuring cylinder between solutions.

Measure out 4.0 cm^3 of **FA 3** from the burette into a test-tube.

Start the reaction by tipping the **FA 3** from the test-tube into the conical flask. Start the stop-clock with one hand and swirl the contents of the flask with the other. Place the flask on a white tile and stop the clock as soon as the colour disappears.

Record the time (in seconds, to the nearest second) in *Table 1.1*.

Repeat the experiment using the different volumes of **FA 1**, **FA 2** and **FA 3** as shown in *Table 1.1*. Where water is required, use the measuring cylinder to add the water to the other solutions in the conical flask.

Experiment 2 is the same as experiment 1 to give you the opportunity of practising the technique.

The 'rate of reaction' can be calculated by using the relationship:

$$\text{'rate'} = \frac{\text{volume of FA 3 in cm}^3}{\text{time in seconds for colour to disappear}}$$

Table 1.1

	1	2	3	4
volume of FA 1 / cm^3	20.0	20.0	10.0	20.0
volume of FA 2 / cm^3	20.0	20.0	20.0	10.0
volume of water / cm^3	0.0	0.0	10.0	10.0
volume of FA 3 / cm^3	4.0	4.0	4.0	4.0
time for colour to disappear / s				
'rate' of reaction				

Calculate each 'rate' and complete *Table 1.1*.

[10]

As the total volume of liquid is the same in each experiment, the volume of any reagent can be used as a measure of its concentration.

(b) Compare experiments 2 and 3.

(i) Which reagents have the same concentration in both experiments?

[1]

(ii) Which reagent has a different concentration?

[1]

(iii) How is the rate of reaction affected by the change of concentration of the reagent named in (ii)?

[3]

(c) Compare experiments 2 and 4.

(i) Which reagents have the same concentration in both experiments?

[1]

(ii) Which reagent has a different concentration?

[1]

(iii) How is the rate of reaction affected by the change of concentration of the reagent named in (ii)?

[3]

(d) A text-book states that the reaction is zero order with respect to iodine. What volumes of reagents, compared with experiment 2, would you mix to investigate this statement?

FA 1 cm³ FA 2 cm³

water cm³ FA 3 cm³

[1]

[Total : 21]



EXPERIMENT Required, no longer needed from 2007 onwards.

- 1 **FB 1** is an aqueous solution of sodium thiosulphate, $\text{Na}_2\text{S}_2\text{O}_3$.
FB 2 is dilute hydrochloric acid, HCl .

When aqueous sodium thiosulphate is mixed with hydrochloric acid, a fine suspension of solid sulphur is formed.

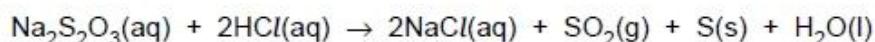

If a beaker containing the reaction mixture is placed over the printed insert provided, the sulphur slowly hides the printing from view.

If the **depth of solution is constant** the printing will always disappear when the same amount of sulphur has been formed.

You are to carry out experiments to determine the order of reaction with respect to sodium thiosulphate.

- (a) Use a 50 cm^3 measuring cylinder to transfer 50 cm^3 of **FB 1** into a 250 cm^3 beaker. Dry the outside of the beaker containing **FB 1** and place it over the printing on the insert sheet.

Measure 5 cm^3 of **FB 2** using a small measuring cylinder or a test-tube graduated at 5 cm^3 .

Pour the 5 cm^3 of **FB 2** from the measuring cylinder/test-tube into the beaker and at the same moment start a stop-clock or note the time on a clock with a seconds display.

Swirl the beaker to mix the solutions thoroughly and place it back over the insert. Then view the insert from above so that it is observed through the depth of the solution.

When the printing on the insert just disappears, record the time to the nearest second in Table 1.1.

Empty the beaker and thoroughly rinse with distilled water.

Repeat the experiment using the volumes of **FB 1**, water and **FB 2** shown in Table 1.1.

Table 1.1

<i>expt</i>	volume of FB 1 / cm^3	volume of water / cm^3	volume of FB 2 / cm^3	time / s	$\left(\frac{1000}{\text{time}}\right)$ / $\text{s}^{-1} \times 10^3$	$\lg(\text{vol FB 1})$	$\lg\left(\frac{1000}{\text{time}}\right)$
1	50	0	5			1.70	
2	40	10	5			1.60	
3	30	20	5			1.48	
4	20	30	5			1.30	
5	15	35	5			1.18	

[6]

Calculate $\left(\frac{1000}{\text{time}}\right)$ correct to one decimal place and $\lg\left(\frac{1000}{\text{time}}\right)$ correct to two decimal places for each experiment. Record your values in Table 1.1. [$\lg = \log_{10}$]

[2]



(b) Plot $\lg\left(\frac{1000}{\text{time}}\right)$ against $\lg(\text{volume of FB 1})$ and draw the best-fit straight line.

Indicate clearly any point which represents an experimental error and was not considered when drawing the best-fit straight line.

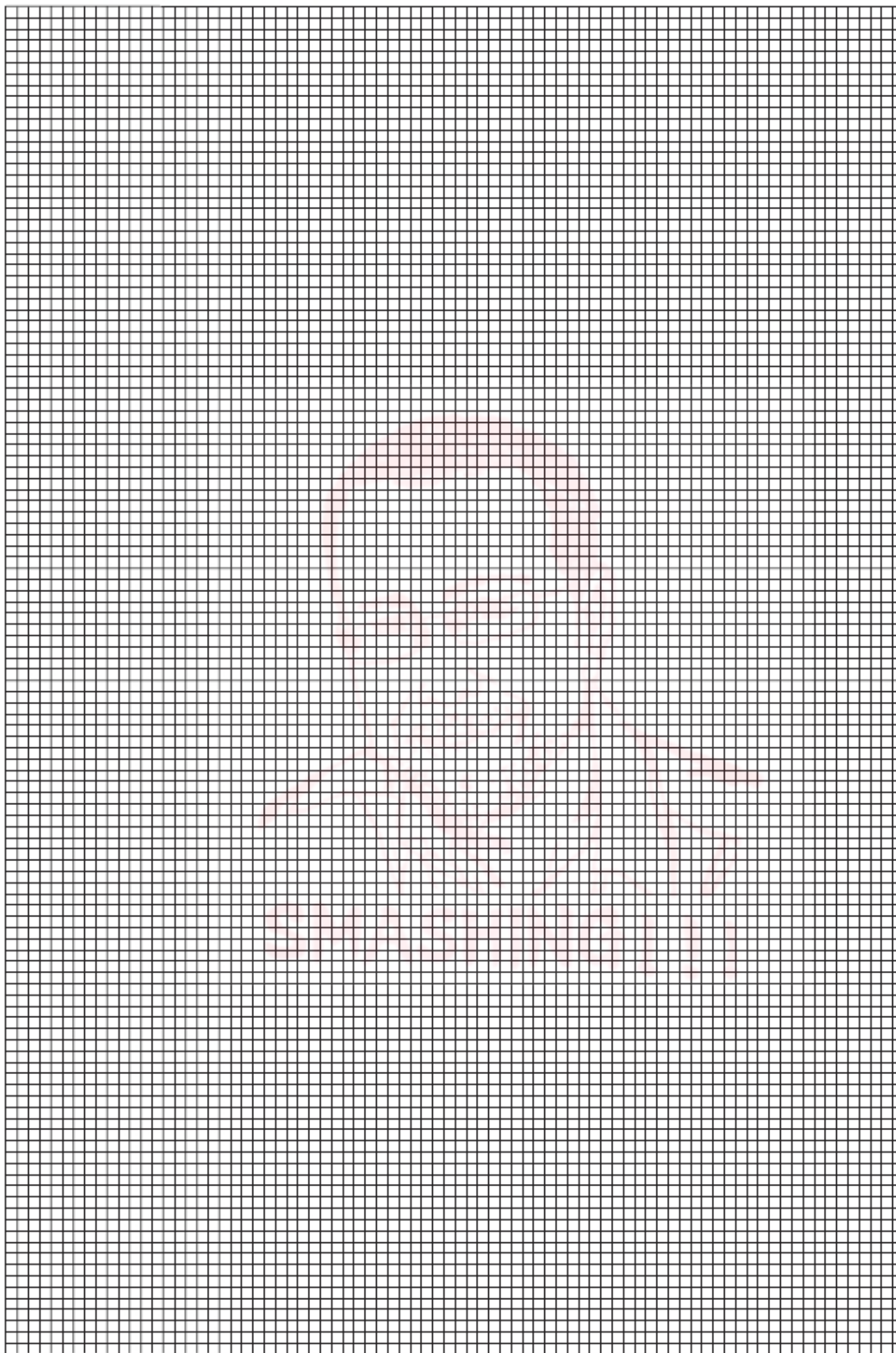

[4]

The rate of reaction with respect to sodium thiosulphate is given by the equation

$$\text{rate} = k [\text{Na}_2\text{S}_2\text{O}_3]^x$$

where k is the rate constant and x is the order of reaction.

The rate equation can be converted into a log form.

$$\lg(\text{rate}) = x \lg[\text{Na}_2\text{S}_2\text{O}_3] + \lg k$$

The rate of reaction can be represented by $\left(\frac{1000}{\text{time}}\right)$, and $[\text{Na}_2\text{S}_2\text{O}_3]$ by the volume of **FB 1** used.

(c) How is the depth of solution kept constant during the experiment?

.....
.....
..... [1]

(d) Explain why the volume of **FB 1** in each experiment is a measure of $[\text{Na}_2\text{S}_2\text{O}_3]$.

.....
.....
..... [2]

(e) The equation

$$\lg(\text{rate}) = x \lg[\text{Na}_2\text{S}_2\text{O}_3] + \lg k$$

is the equation for a straight line and the order of reaction, x , is the gradient of the line.

Calculate the value of x from the graph you have drawn on page 3.

You must:

draw suitable construction lines on the graph,

show the numbers obtained from the graph and their use in the calculation.

The numerical value of x , the order of the reaction, is [3]



ASSESSMENT OF PLANNING SKILLS

The rate of reaction between aqueous sodium thiosulphate solution and hydrochloric acid may also be affected by the concentration of the hydrochloric acid.

- (f) Enter, in Table 1.2, the time and the calculated rate, $\left(\frac{1000}{\text{time}}\right)$, from page 2, for *experiment 2*.

Data from two further experiments, *experiments 6 and 7*, together with that from *experiment 2*, can be used to investigate how the rate of reaction varies as the concentration of hydrochloric acid varies. Enter, in Table 1.2, the volumes of **FB 1**, water and **FB 2** that you would use in *experiments 6 and 7* to obtain this data.

Carry out *experiments 6 and 7*, and record the time and $\left(\frac{1000}{\text{time}}\right)$ for each in Table 1.2.

Table 1.2

<i>expt</i>	volume of FB 1 / cm ³	volume of water / cm ³	volume of FB 2 / cm ³	time / s	$\left(\frac{1000}{\text{time}}\right)$ / s ⁻¹ × 10 ³
2	40	10	5		
6					
7					

[3]

- (g) Use your results to suggest how the rate of reaction depends on the concentration of hydrochloric acid.

.....

.....

..... [1]

[Total: 22]

1 Hydrochloric acid and magnesium ribbon react to produce hydrogen gas.



You are to plan the details of an experiment, based on the volume of gas produced in the reaction, to investigate how the rate of reaction depends on the concentration of the hydrochloric acid.

(a) Using scientific knowledge linking molecular or ionic collisions to rates of reaction, predict the relationship between

(i) the rate of formation of hydrogen gas and the concentration of the hydrochloric acid,

.....
.....
.....

(ii) the rate of formation of hydrogen gas and the temperature of the reaction.

.....
.....
.....

[2]

(b) In an experiment to determine the rate of reaction with respect to HCl identify the independent variable.

..... [1]

(c) Identify **one** variable, other than temperature, that must be controlled in the experiment.

.....
..... [1]



Handwriting practice lines consisting of 20 horizontal dotted lines.

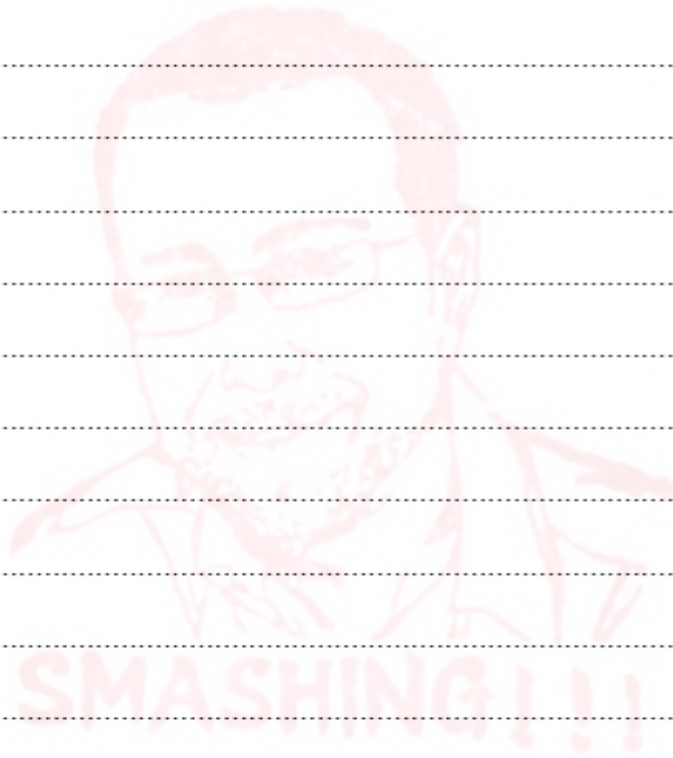

[7]



- 2 Students were asked to investigate how the rate of reaction between magnesium ribbon and hydrochloric acid varied with change in concentration of the acid.

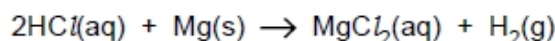

Student 1, looking at the equation, suggested the following.

$$\text{rate of production of hydrogen gas} = k[\text{HCl}]^2$$

This student used the following apparatus to investigate the rate of production of hydrogen gas, H_2 .

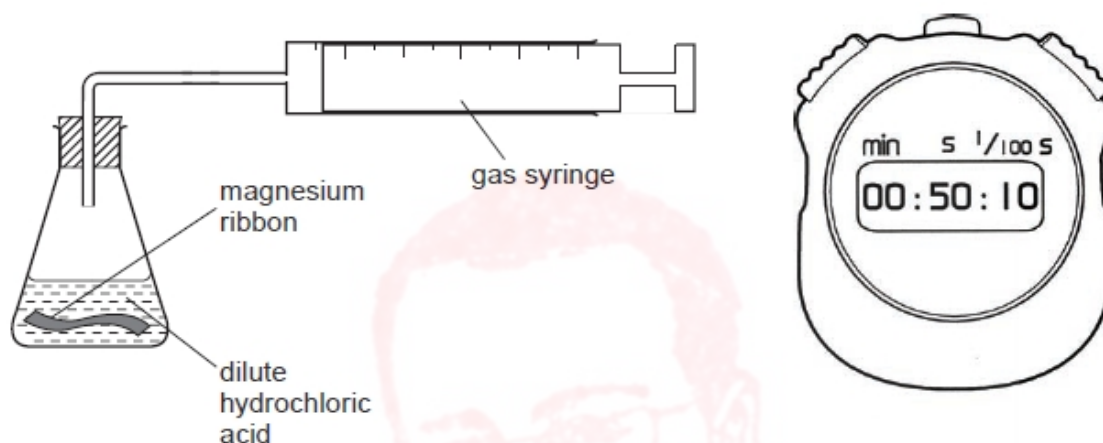

The student used a 500 cm^3 measuring cylinder to measure 100 cm^3 of dilute acid into a conical flask.

A 1 cm length (0.01 g) of magnesium ribbon was dropped into the acid in the flask and the stopper quickly replaced in the flask.

The stop-clock was started and the volume of gas collected was measured at 0.5 minute intervals. The results of the experiment were recorded as shown in the table below.

time / min	volume of H_2 / cm^3	time / min	volume of H_2 / cm^3
0.5	15.5	5.5	80.0
1.0	25.0	6.0	82.5
1.5	34.0	6.5	85.0
2.0	43.0	7.0	87.0
2.5	51.0	7.5	87.5
3.0	59.0	8.0	91.0
3.5	65.0	8.5	92.5
4.0	69.5	9.0	93.5
4.5	74.0	9.5	94.5
5.0	75.0	10.0	95.0

(a) Plot a graph of volume of hydrogen produced against time.

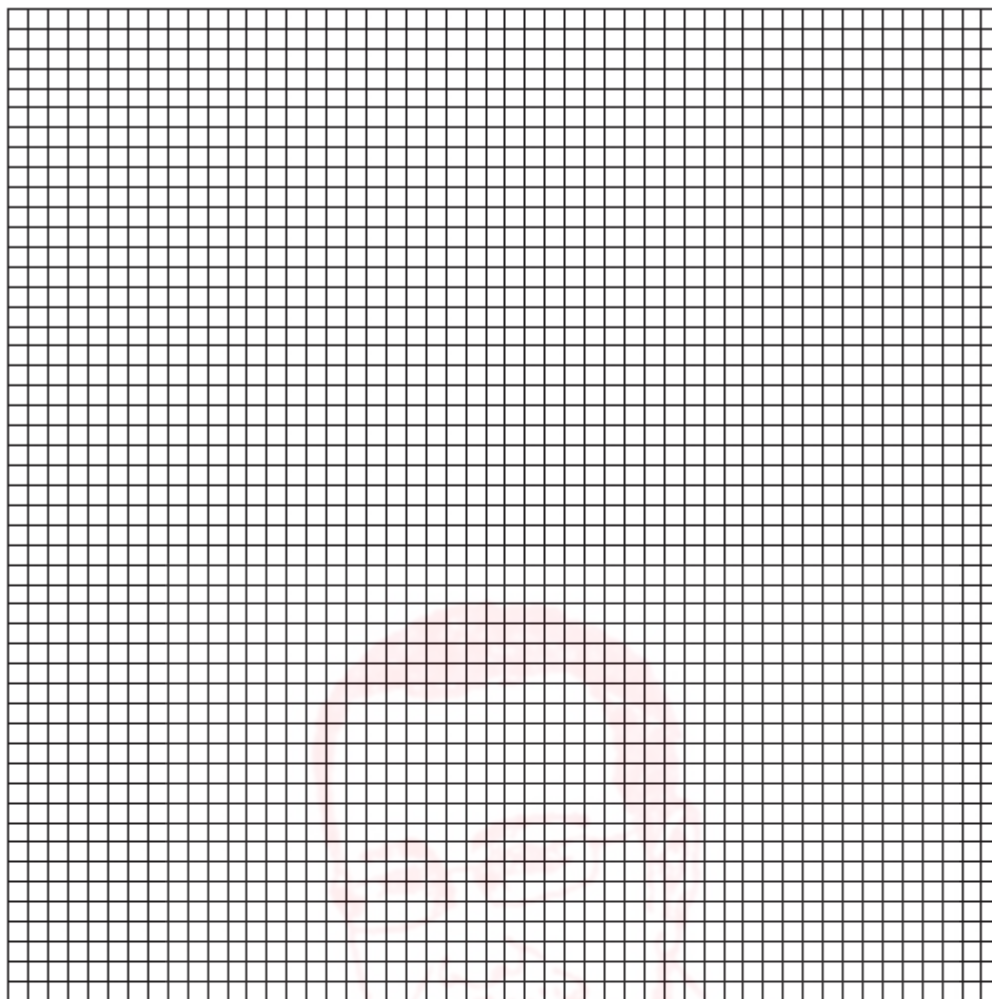

[2]

(b) Identify clearly on your graph any anomalous readings and suggest a reason for these anomalous readings.

.....
..... [1]

(c) On the graph you have plotted, construct a line from which you can calculate the initial rate of reaction.

Calculate the initial rate of reaction and show your working.

initial rate = $\text{cm}^3 \text{min}^{-1}$ [2]



- (d) By considering the experimental method described, explain why the plotted line does not pass through 0,0.

.....
..... [1]

- (e) Identify a further source of error in the method described and suggest a change to the method to reduce this error.

.....
.....
..... [1]

- (f) Students 2-8 carried out similar experiments with different concentrations of acid. The initial rate of reaction was calculated for each of their experiments and is shown in the table below.
Enter in the table the initial rate you have calculated for Student 1.

student	volume of acid used / cm ³	volume of water used / cm ³	mass of magnesium used / g	initial rate / cm ³ min ⁻¹	relative concentration of acid
1	100	0	0.01		1.0
2	45	55	0.01	8.0	
3	90	10	0.01	16.4	
4	60	40	0.01	11.5	
5	100	100	0.01	9.3	
6	35	65	0.01	6.8	
7	80	20	0.01	15.2	
8	60	240	0.01	3.3	

Use the additional column of the table to record calculated values for the relative concentration of the hydrochloric acid.

$$\text{relative concentration of acid} = \frac{\text{volume of acid used}}{\text{total volume}}$$

[1]

1 One method of studying the kinetics of a reaction is by the initial rates method.

To determine the initial rate we can time how long it takes to reach an identifiable point early in the reaction.

In solution, iodide ions, I^- , are oxidised by persulfate ions, $S_2O_8^{2-}$.

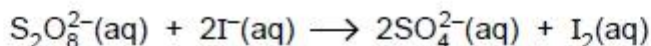

If sodium thiosulfate and starch are added to the reaction mixture, the blue-black colour of an iodine-starch complex appears suddenly. This occurs when all of the thiosulfate ions, $S_2O_3^{2-}$, present in the mixture have reacted with the iodine formed in the reaction above. This is the identifiable point in the reaction.

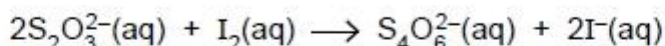

You are to plan an experiment to investigate how the rate of reaction between potassium persulfate and potassium iodide depends on the concentration of potassium persulfate.

A preliminary experiment, using approximate volumes of solution, indicates that the time taken for the iodine-starch complex to form doubles when the potassium persulfate is diluted with an equal amount of water.

(a) Using the results of the preliminary experiment predict the relationship between the concentration of potassium persulfate and the rate of reaction.

.....

Explain your prediction in terms of the particles (ions) present in the solution.

.....

.....

.....[2]

(b) (i) Identify the independent variable in the investigation.

.....

(ii) Identify the dependent variable in the investigation.

.....[2]

(c) Explain why it is important that the iodine formed by oxidation reacts with the sodium thiosulfate and is converted back to iodide ions.

.....

.....

.....[1]



1 Iodide ions, I^- , and persulfate ions, $S_2O_8^{2-}$, react according to the following equation.

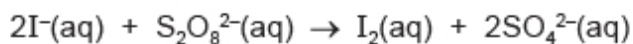

The rate of reaction between these ions can be determined from the time it takes for a certain amount of iodine, $I_2(aq)$, to be produced.

- A mixture of solutions is prepared, containing known volumes of
 - aqueous ammonium persulfate, $(NH_4)_2S_2O_8(aq)$,
 - aqueous sodium thiosulfate, $Na_2S_2O_3(aq)$,
 - starch indicator.
- A known volume of aqueous potassium iodide, $KI(aq)$, is added to this mixture and a timer is started.
- After the reactants are mixed, they react slowly to produce iodine, $I_2(aq)$.
- Any iodine initially produced is removed by a reaction with thiosulfate ions.

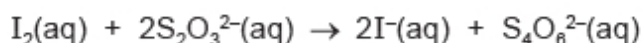

- Iodine, $I_2(aq)$, is continuously removed until all of the thiosulfate ions have been used up.
- After that time any $I_2(aq)$ that is produced turns the starch indicator blue.
- The time of the first appearance of the blue colour is recorded.
- This procedure is repeated with different volumes of reactants, keeping the total volume of the reaction mixture constant by adding the required volume of distilled water.

You are to plan a series of experiments to determine the effect of changing the concentration of iodide ions on the rate of reaction.

You are provided with the following materials.

solid ammonium persulfate, $(NH_4)_2S_2O_8(s)$

0.20 mol dm^{-3} aqueous KI , a source of $I^-(aq)$

$0.0050 \text{ mol dm}^{-3}$ aqueous $Na_2S_2O_3$, a source of $S_2O_3^{2-}(aq)$

starch indicator

- (a) (i)** Calculate the mass of $(NH_4)_2S_2O_8(s)$ that would be required to prepare 250 cm^3 of a standard solution of concentration 1.00 mol dm^{-3} .

[A_r values: N, 14.0; H, 1.0; S, 32.1; O, 16.0]

mass of $(NH_4)_2S_2O_8(s) = \dots\dots\dots \text{ g [1]}$



- (ii) Describe how, after weighing the mass calculated in (i), you would prepare this standard solution for use in your experiment.

Give the name and capacity, in cm^3 , of any apparatus used.

.....

.....

.....

.....

..... [2]

- (iii) Explain how the use of starch solution improves the accuracy of the experiment.

.....

.....

..... [1]

- (b) A student planned five experiments to investigate the effect of iodide concentration, $[\text{I}^-]$, on the rate of reaction. The table shows the volumes used in experiment 1.

Complete the table for experiments 2 to 5.

experiment	volume of 1.00 mol dm^{-3} $(\text{NH}_4)_2\text{S}_2\text{O}_8(\text{aq})$ / cm^3	volume of 0.20 mol dm^{-3} $\text{KI}(\text{aq})$ / cm^3	volume of water / cm^3	volume of $0.0050 \text{ mol dm}^{-3}$ $\text{Na}_2\text{S}_2\text{O}_3(\text{aq})$ / cm^3	volume of starch solution / cm^3
1	25.0	10.0	0.0	5.0	1.0
2				5.0	1.0
3				5.0	1.0
4				5.0	1.0
5				5.0	1.0

[3]



(c) In a different experiment, a student mixed the following solutions and measured the time taken for the reaction.

- 10.0 cm³ of 1.00 mol dm⁻³ (NH₄)₂S₂O₈(aq)
- 5.0 cm³ of 0.0050 mol dm⁻³ Na₂S₂O₃(aq)
- 5.0 cm³ of 0.20 mol dm⁻³ KI(aq)
- 1.0 cm³ of starch indicator

(i) The time taken for the blue colour to appear was 134 seconds (to the nearest second).

Calculate the rate of production of moles of I₂, in mol dm⁻³ s⁻¹.

rate of production of moles of I₂ = mol dm⁻³ s⁻¹ [3]

(ii) What should the student have done to make sure that the results were reliable?

.....
..... [1]

(iii) The 5.0 cm³ of 0.0050 mol dm⁻³ Na₂S₂O₃(aq) was measured using a 50 cm³ burette which had graduations every 0.1 cm³.

Calculate the maximum percentage error in the measured volume of this solution.

percentage error = % [1]

(d) A second student tried to perform the same experiment but found that the reaction mixture turned blue immediately after KI(aq) was added.

State what error the student had made.

.....
..... [1]

- (e) The following information gives some of the hazards associated with the chemicals used in the procedure.

Ammonium persulfate	Solid is oxidising and hazardous to the environment . Contact with combustible material may cause fire. It is classified as health hazard , is harmful if swallowed and is irritating to eyes, respiratory system and skin. Solutions equal to or more concentrated than 0.2mol dm^{-3} should be labelled health hazard and hazardous to the environment . Solutions equal to or more concentrated than 0.05mol dm^{-3} but less concentrated than 0.2mol dm^{-3} should be labelled health hazard .
Potassium iodide	All solutions are low hazard.
Sodium thiosulfate	All solutions are low hazard.

Describe **one** relevant precaution, other than eye protection and a lab coat, that should be taken to keep the risk associated with the chemicals used to a minimum. Explain your answer.

.....

.....

..... [1]

[Total: 14]

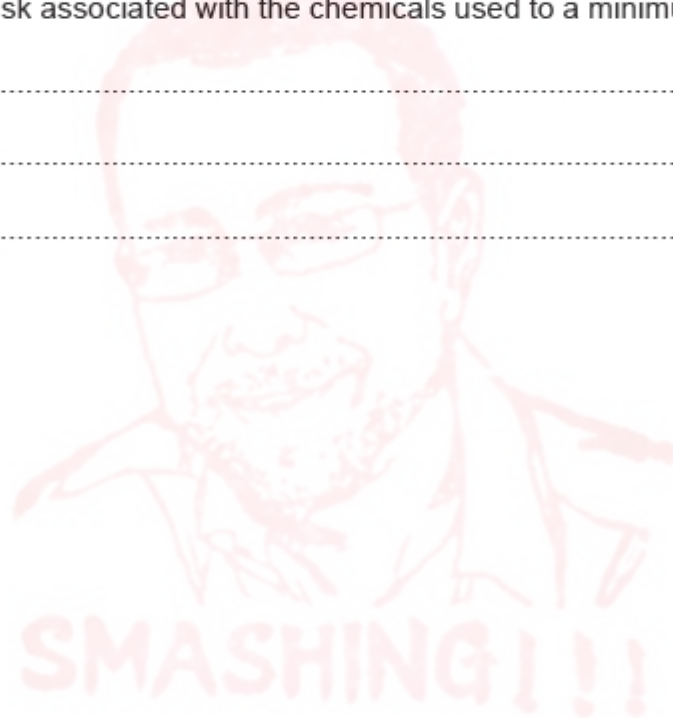

2 The activation energy, E_a , of the reaction between aqueous manganate(VII) ions, MnO_4^- (aq), and aqueous ethanedioate ions, $\text{C}_2\text{O}_4^{2-}$ (aq), can be determined as follows.

- step 1** Use a pipette to transfer 10.00 cm^3 of $0.0200 \text{ mol dm}^{-3} \text{ MnO}_4^-$ (aq) into a boiling tube.
- step 2** Use a second pipette to transfer 10.00 cm^3 of $0.0500 \text{ mol dm}^{-3} \text{ C}_2\text{O}_4^{2-}$ (aq) into a second boiling tube.
- step 3** Place both boiling tubes into a water-bath at approximately 50°C and allow the temperature of both solutions to become equal and constant.
- step 4** Record this constant temperature.
- step 5** Pour the $\text{C}_2\text{O}_4^{2-}$ (aq) solution into the boiling tube containing the MnO_4^- (aq) solution and immediately start the timer. Continue to stir the mixture during the reaction.
- step 6** When the reaction finishes, stop the timer and record the time.
- step 7** Repeat the experiment at different temperatures and record the results.

The student used their recorded data to complete columns 1–3 of the table.

experiment number	average temperature of reaction mixture (T) /K	time (t)/s	$\frac{1}{T}/\text{K}^{-1}$	$\log t$
1	333	11		
2	323	35		
3	315	76		
4	310	145		
5	304	284		

(a) An extra procedural step in the method is required in order to be able to calculate the average temperature of the reaction mixture throughout each experiment.

State the extra procedural step that needs to be done.

..... [1]

(b) Complete the empty columns in the table, giving all values to **three significant figures**. [2]

(c) Suggest why an experiment with an average temperature of 70°C (343K) would produce a result that is less accurate than the other experiments.

..... [1]



(d) Identify the dependent variable.

..... [1]

(e) Plot a graph on the grid to show the relationship between $\log t$ and $\frac{1}{T}$. Use a cross (x) to plot each data point. Draw a line of best fit.

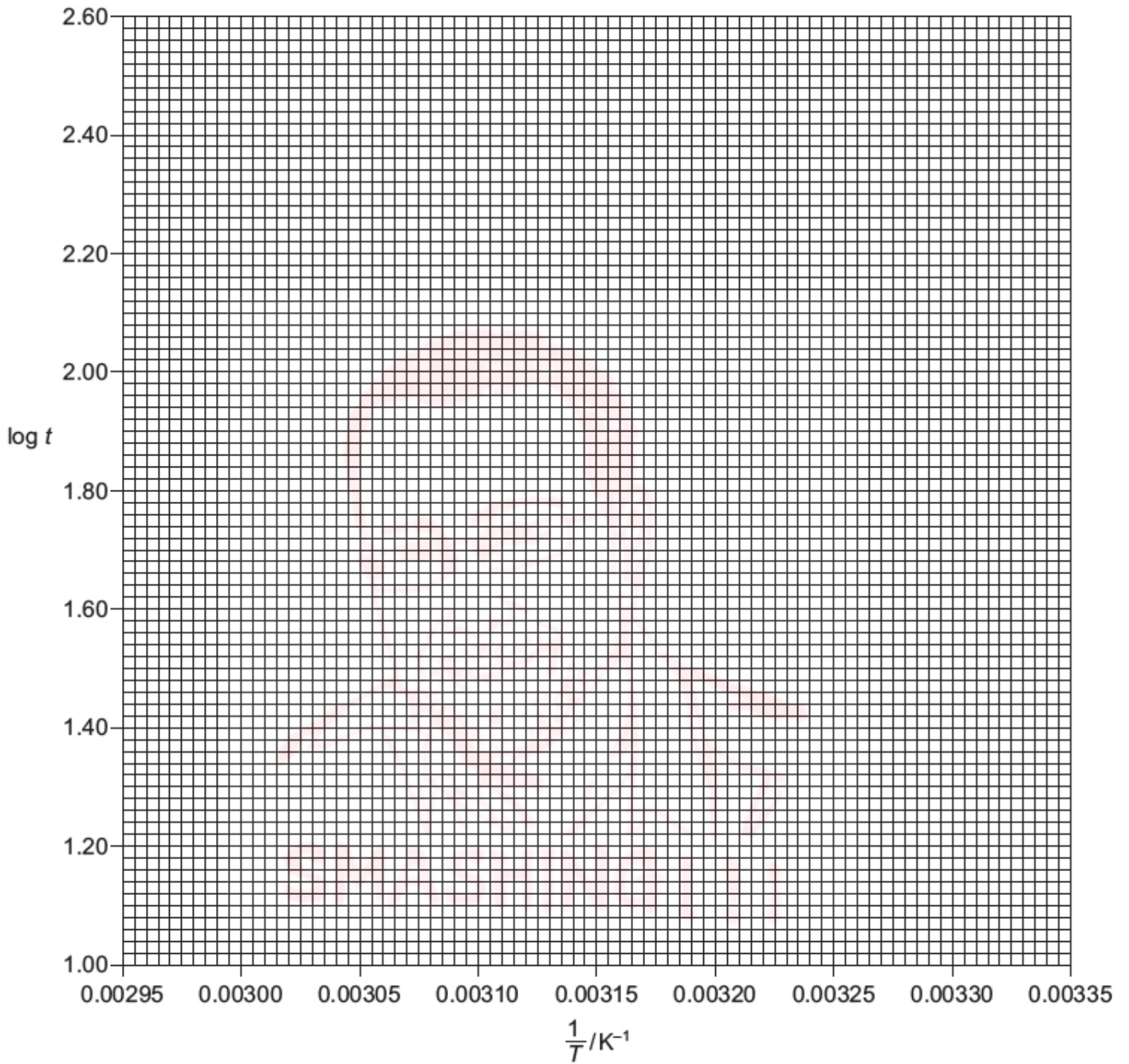

[2]



(f) The equation for the line of best fit is shown.

$$\log t = \frac{E_a}{2.303 RT} + \text{constant}$$

$$R = 8.314 \text{ J mol}^{-1} \text{ K}^{-1}$$

(i) Use your graph to determine the gradient of the line of best fit.

State the coordinates of both points you used in your calculation. These must be selected from your line of best fit.

Give the gradient to **three significant figures**.

coordinates 1 coordinates 2

gradient = K
[2]

(ii) Determine the activation energy, E_a , of this reaction.

Give your answer to **three significant figures**. Include units.

E_a =
units =
[2]

[Total: 11]

1 Hydrogen peroxide decomposes slowly at room temperature to give water and oxygen.



The **initial** rate of this reaction can be increased by the addition of a metal oxide catalyst.

A student is asked to investigate which metal oxide catalyst is best at increasing the **initial** rate of this reaction by using a method which involves the collection of oxygen.

The student is provided with the following metal oxides: copper(II) oxide, iron(III) oxide, manganese(IV) oxide, nickel(II) oxide and titanium(IV) oxide.

The student is also provided with an excess volume, of a known concentration, of aqueous hydrogen peroxide and any laboratory equipment needed.

(a) (i) State the independent variable.

..... [1]

(ii) State the dependent variable.

..... [1]

(b) State two variables that would need to be controlled.

1

2

[2]

(c) Draw a labelled diagram of the assembled apparatus that could be used to carry out these experiments. The apparatus should allow the accurate recording of the oxygen produced.

[3]



(d) (i) What measurements need to be recorded during the course of each experiment to allow the **initial** rate to be determined?

..... [1]

(ii) How is the **initial** rate determined using these measurements?

.....
..... [1]

(e) How can the student ensure that the results are reliable?

..... [1]

(f) Suggest an alternative method to investigate these reactions which does not include the collection of gas.

.....
..... [1]

(g) Once the reaction has finished, how can the student demonstrate that the metal oxide has not been affected by the reaction?

.....
.....
.....
..... [2]

(h) When aqueous hydrogen peroxide is stored there is a small hole in the lid of the bottle. Suggest why this is necessary.

.....
..... [1]

[Total: 14]



EXPERIMENT Required, no longer needed from 2007 onwards.

- 1 In the presence of hydrogen ions, H^+ , bromate(V) ions, BrO_3^- , oxidise bromide ions, Br^- , to bromine, Br_2 .

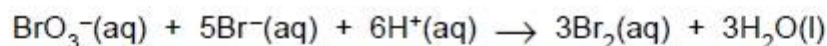

The reaction is relatively slow and can be followed by adding aqueous phenol and the indicator methyl orange to the reaction mixture.

As bromine is formed it reacts rapidly with the phenol present until the latter is used up. The free bromine now in solution bleaches the methyl orange indicator. The reaction is timed from the mixing of the solutions until the colour of the indicator is lost.

You are to investigate how the rate of reaction depends on the concentrations of bromate(V), bromide and hydrogen ions.

FB 1 is aqueous phenol containing methyl orange indicator.

FB 2 is aqueous potassium bromide, KBr .

FB 3 is aqueous potassium bromate(V), KBrO_3 .

FB 4 is 0.50 mol dm^{-3} sulphuric acid, H_2SO_4 .

You will also require a supply of distilled water.

- (a) Fill the burette labelled **FB 1** with the phenol/indicator solution, **FB 1**, and the burette labelled **FB 4** with the sulphuric acid, **FB 4**.

Experiment 1

Run 20 cm^3 of **FB 1** from the burette into the conical flask.

Use measuring cylinder **A** to add 50 cm^3 of **FB 2** to the flask.

From the second burette, run into the flask 20 cm^3 of **FB 4**.

Use measuring cylinder **B** to measure 50 cm^3 of **FB 3**.

Pour the **FB 3** from the measuring cylinder into the flask and at the same time start the stop-clock or note the time on a clock.

Swirl the flask to ensure a uniform solution and place the flask on the white tile. Stop the clock or note the time when the colour of the indicator just disappears to leave a colourless solution. Record the time, to the nearest second, in Table 1.1 at the top of page 3.

Experiment 2

Empty and rinse the flask used in *Experiment 1*. Shake out as much of the rinse water as possible or dry the flask using a paper towel.

Repeat the experiment using the volumes of solution shown in Table 1.1 for *Experiment 2*.

It is important that measuring cylinder **A** is only used for potassium bromide solution, **FB 2**, and water, and measuring cylinder **B** only for potassium bromate solution, **FB 3**.

Experiments 3 and 4

Repeat the experiment using the volumes of solution shown in Table 1.1 for each of these experiments and complete the table.

Table 1.1

Expt	in flask				in measuring cylinder	time /s	rate (1000/time) /s ⁻¹ x 10 ³
	volume of FB 1 (phenol) /cm ³	volume of FB 2 (KBr) /cm ³	volume of FB 4 (H ₂ SO ₄) /cm ³	volume of water /cm ³			
1	20	50	20	0	50		
2	20	50	20	10	40		
3	20	30	20	20	50		
4	20	30	40	0	50		

[1] + [10]

(b) Why is the total volume used in each experiment kept constant?

.....[1]

Processing of results

(c) How is the rate of reaction affected by changing the concentration of BrO₃⁻ ion?

Use, in **calculations**, the experimental data from *Experiment 1* and *Experiment 2* to suggest the order of reaction with respect to the bromate(V) ion, BrO₃⁻.

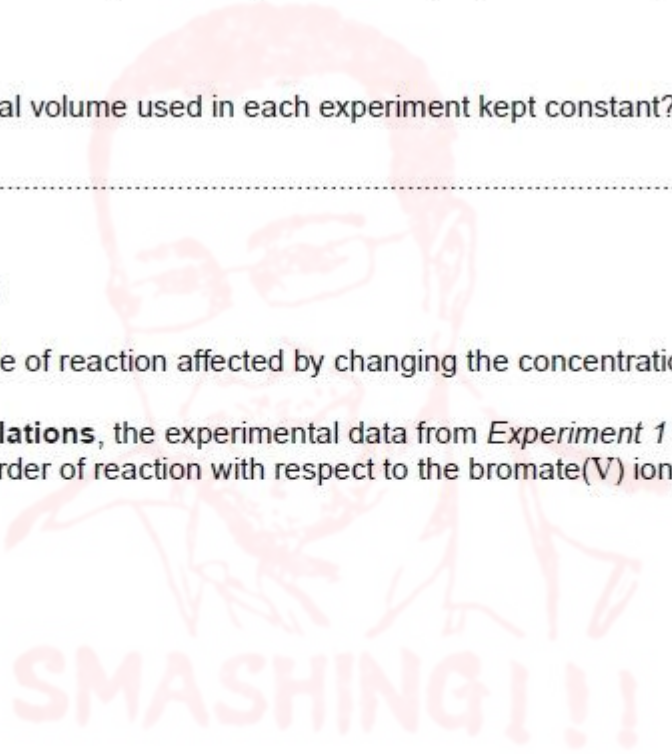

[3]

(d) How is the rate of reaction affected by changing the concentration of Br⁻ ions?

Use, **in calculations**, the experimental data from *Experiment 1* and *Experiment 3* to suggest the order of reaction with respect to the bromide ion, Br⁻.

[3]

(e) How is the rate of reaction affected by changing the concentration of H⁺ ions?

Use, **in calculations**, selected experimental data from *a pair of experiments* to suggest the order of reaction with respect to the hydrogen ion, H⁺.

Which *pair of experiments* have you selected?

.....

Calculations

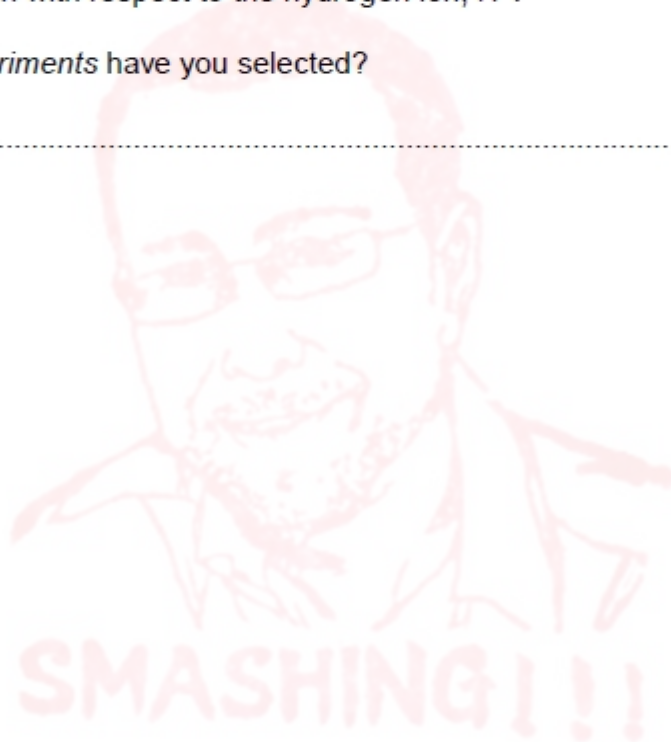

[2]

[Total : 20]

- 2 Chemical reactions occur more rapidly as the temperature of the reaction mixture increases. The mathematical relationship that summarises this is

$$\log_{10} (\text{rate of reaction}) = \frac{-E_A}{19T}$$

where E_A is the **activation energy** of the reaction and T is the **absolute temperature** in Kelvin and the **rate of reaction** can be taken as the reciprocal of the time taken in seconds (**1/time**).

An experiment was carried out to investigate this relationship using dilute hydrochloric acid and aqueous sodium thiosulfate.

- 20 cm³ of dilute hydrochloric acid was placed in a boiling tube contained in a water bath.
- 20 cm³ of aqueous sodium thiosulfate was added to the dilute hydrochloric acid, while stirring and a stopwatch started.
- The temperature of the water bath was recorded.
- After a period of time the liquid became cloudy (opaque) due to the formation of a precipitate of sulfur.
- As soon as this cloudiness (opacity) appeared the time was recorded.
- The temperature of the water bath was raised and the whole experiment repeated.

- (a) The results of several such experiments are recorded below.

Process the results in the table to calculate \log_{10} (rate of reaction), the reciprocal of the absolute temperature ($1/T$) and the 'rate of reaction' ($1/\text{time}$). You should expect the values of \log_{10} (rate of reaction) to be negative.

Record these values to **three significant figures** in the additional columns of the table.

Label the columns you use. For each column you use include units where appropriate and an expression to show how your values are calculated.

You may use the column headings A to F for these expressions (e.g. A–B). [3]

A	B	C	D	E	F
temperature /°C	absolute temperature /K	time /s			
20.0	293	60.3			
30.0	303	46.8			
40.0	313	41.6			
45.0	318	31.6			
50.0	323	28.8			
55.0	328	25.1			
60.0	333	21.0			
65.0	338	20.4			
70.0	343	18.1			
80.0	353	15.1			

- (b) Plot a graph to show the relationship between \log_{10} (rate of reaction) and the reciprocal of the absolute temperature. You are reminded that the values for \log_{10} (rate of reaction) are negative.

Draw the line of best fit.

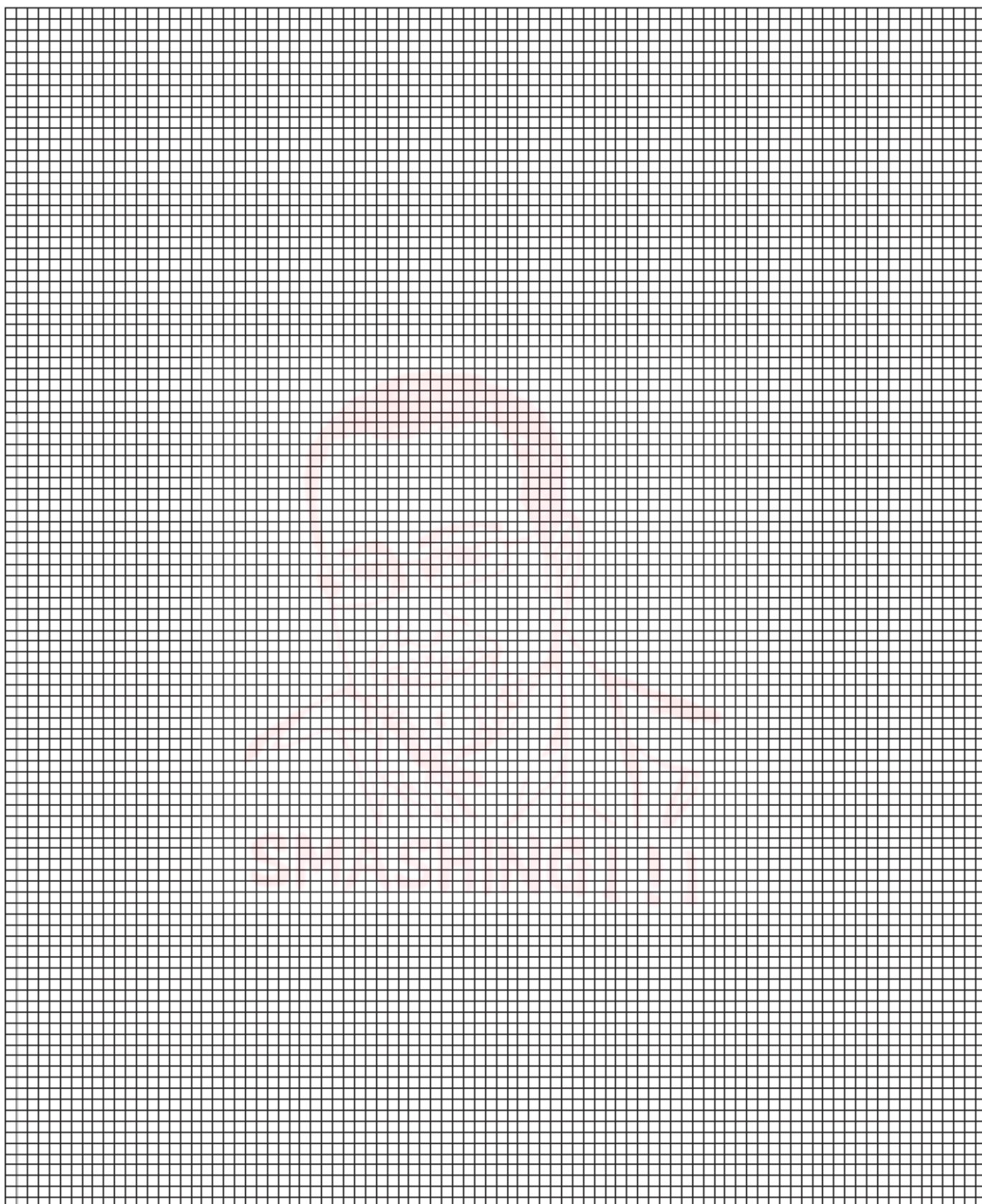

[3]

- (g) By considering the movement of particles in the reaction explain why the rate of reaction increases with increasing temperature.

[2]

[Total: 15]



- 2 In aqueous solution, glucose can be slowly hydrolysed. The reaction appears to be first-order with respect to the glucose. As the hydrolysis proceeds, samples of the glucose solution can be analysed at regular intervals and the concentrations recorded. If the reaction is first-order, the following equation can be used to verify this.

$$\log_{10} a - \log_{10}(a-x) = kt$$

where a is the initial concentration of glucose, x is the decrease in the concentration of the glucose, $a-x$ is the glucose concentration at any time t and k is a constant.

A plot of $\log_{10}(a-x)$ against time will be linear for a first-order reaction and the slope will be equal to $-k$.

- (a) The experimentally determined values of such a hydrolysis experiment carried out at 298 K are recorded below.

You should use a value of $1.000 \text{ mol dm}^{-3}$ for a .

Process the results in the table to enable you to plot a graph of $\log_{10}(a-x)$ against time t .

Record these values to **three significant figures** in the additional columns of the table.

Label the columns you use. For each column you use, include units where appropriate and an expression to show how your values are calculated.

You may use the column headings A to D in these expressions (e.g. A-B).

A	B	C	D
time / min	decrease in the glucose concentration / mol dm^{-3}		
0	0.000		
30	0.101		
60	0.193		
100	0.259		
130	0.370		
180	0.469		
210	0.551		
240	0.573		
270	0.617		
300	0.655		

[2]

- (b) Present the data calculated in (a) in graphical form. Draw the line of best fit. In plotting this graph, it is necessary to show an origin for both axes. Remember that the values of $\log_{10}(a-x)$ are negative.

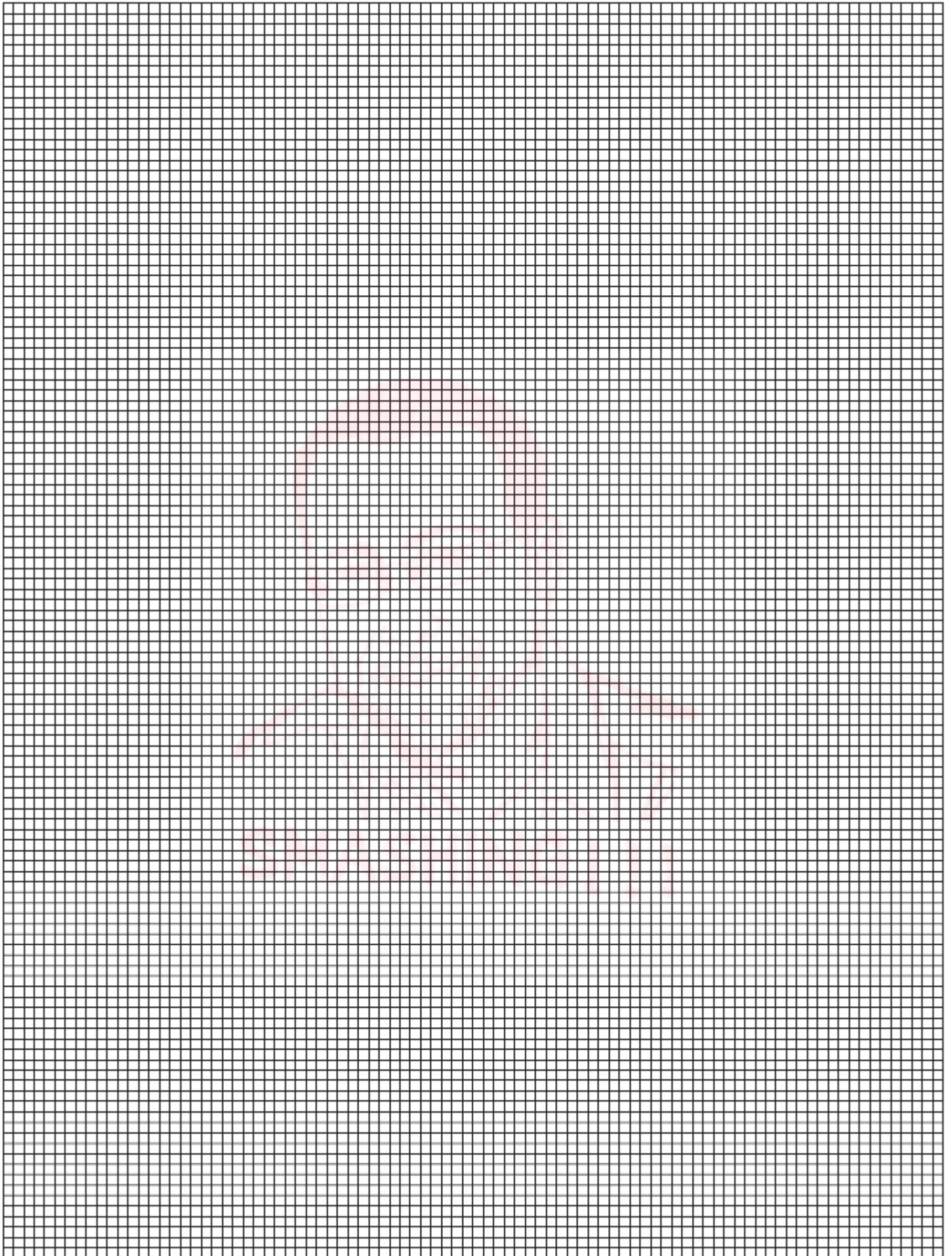

[3]

- (c) Circle and label on the graph in (b) any point(s) you consider to be anomalous. For each anomalous point give a different reason why it is anomalous clearly indicating which point(s) you are describing.

.....

.....

.....

..... [3]

- (d) Comment on the reliability of the data provided in (a).

.....

.....

..... [1]

- (e) Determine the slope of the graph. Mark clearly on the graph any construction lines and show clearly in your calculation how the intercepts were used in the calculation of the slope. Record the value of the slope to **three significant figures** with appropriate units.

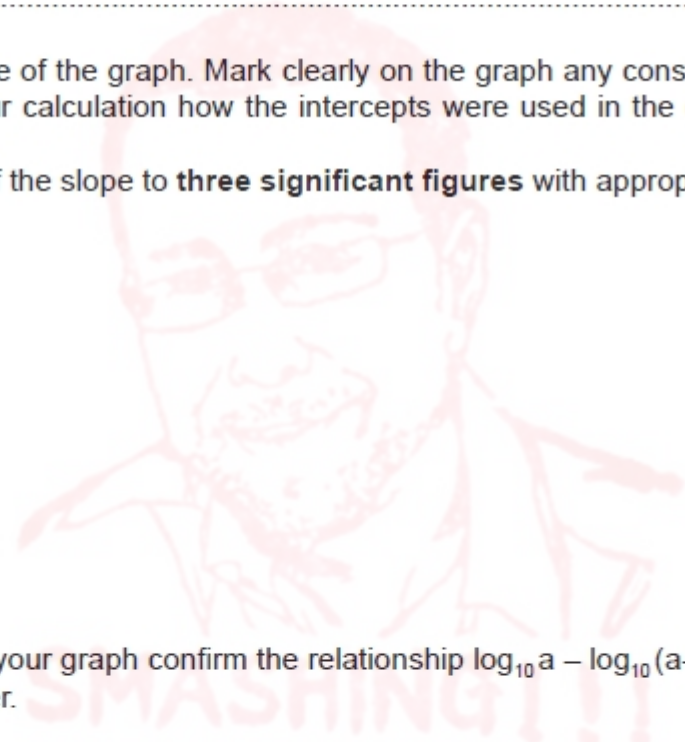

[3]

- (f) Do the results and your graph confirm the relationship $\log_{10} a - \log_{10}(a-x) = kt$? Explain your answer.

[1]

- (g) On your graph, draw another line to show how an increase in temperature would affect your results.

[2]

[Total: 15]



1 Propanone, CH_3COCH_3 , is an organic liquid which is soluble in water.

Aqueous propanone reacts with aqueous iodine. The reaction is catalysed by $\text{H}^+(\text{aq})$ ions.



The order of reaction with respect to iodine can be determined experimentally.

An experiment is carried out using the following solutions.

- solution **A**, 25.0 cm^3 of $1.00 \text{ mol dm}^{-3} \text{ CH}_3\text{COCH}_3(\text{aq})$
- solution **B**, 25.0 cm^3 of $1.00 \text{ mol dm}^{-3} \text{ H}_2\text{SO}_4(\text{aq})$
- solution **C**, 50.0 cm^3 of $0.200 \text{ mol dm}^{-3} \text{ I}_2(\text{aq})$

The solutions are mixed to start the reaction. At certain time intervals, a 10.0 cm^3 portion of the mixture is withdrawn and transferred to a conical flask containing excess sodium hydrogencarbonate, $\text{NaHCO}_3(\text{aq})$. This prevents any further significant reaction taking place by removing the $\text{H}^+(\text{aq})$ ions. The concentration of unreacted $\text{I}_2(\text{aq})$ in each 10.0 cm^3 portion of the mixture can then be determined by titration with aqueous thiosulfate ions, $\text{S}_2\text{O}_3^{2-}(\text{aq})$.

(a) State the size and type of apparatus needed to prepare a suitable volume of a standard solution of $1.00 \text{ mol dm}^{-3} \text{ CH}_3\text{COCH}_3(\text{aq})$ from liquid propanone.

Calculate the mass of propanone needed to prepare this standard solution.

[A_r : C, 12.0; H, 1.0; O, 16.0]

apparatus

mass of propanone g
[3]

(b) Solutions **A**, **B** and **C** need to be added in a specific order and the clock started as the third solution is added.

(i) Suggest the best order of adding the solutions.

1

2

3

[1]

(ii) Explain your choice.

.....

..... [1]

(c) Each 10.0 cm³ portion of mixture removed from the main reaction is added to a separate solution of sodium hydrogencarbonate, NaHCO₃(aq), in a conical flask to remove H⁺(aq) ions.

(i) Which piece of apparatus should be used to transfer each 10.0 cm³ portion of mixture to the conical flask?

..... [1]

(ii) Suggest **two** reasons why NaHCO₃(aq) is preferred to NaOH(aq) as the reagent used to remove H⁺(aq) ions.

reason 1

.....

reason 2

.....

[2]

- (d) The unreacted iodine in each 10.0 cm³ portion of the mixture is titrated against 0.100 mol dm⁻³ aqueous thiosulfate ions, S₂O₃²⁻(aq), to determine the concentration of I₂(aq) in the mixture at the time that the 10.0 cm³ portion was withdrawn.

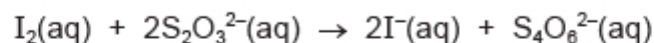

- (i) A 10.0 cm³ portion of mixture is removed at time = 0. This is before any of the 0.200 mol dm⁻³ I₂(aq) had reacted.

Calculate the volume of 0.100 mol dm⁻³ S₂O₃²⁻(aq) needed to react with the iodine present in this 10.0 cm³ portion of mixture.

volume 0.100 mol dm⁻³ S₂O₃²⁻(aq) = cm³ [3]

- (ii) Suggest the name of a suitable indicator to use in the titration and state its colour change.

indicator

colour change

[2]

- (e) State **two** variables which must be recorded in this experiment.

For each variable, state the units.

variable 1 units

variable 2 units

[2]

- (f) State **one** other variable which must be controlled in this experiment.

..... [1]

(g) The order of reaction with respect to iodine is expected to be first order.

(i) Use the axes below to draw a sketch graph of how the concentration of iodine changes during the experiment. Label both axes.

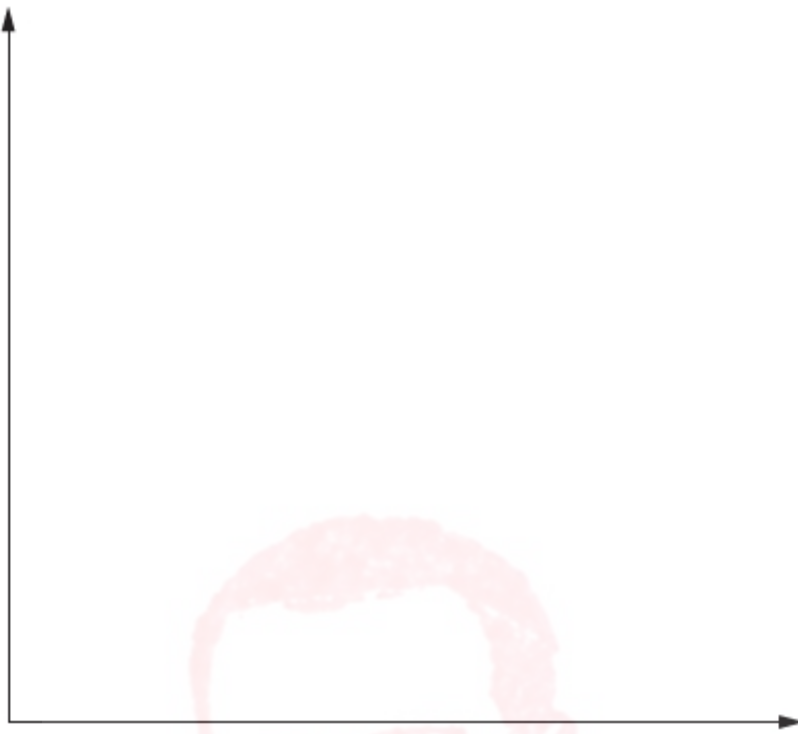

[2]

(ii) How could the graph be used to prove that the order of reaction with respect to iodine is first order?

.....
.....
..... [1]

(h) A student suggested that the temperature at which the experiment was carried out would affect the order of reaction with respect to iodine.

State if the student was correct and explain your answer.

.....
..... [1]

[Total: 20]



- 2 Activation energy, E_{A} , is the minimum energy with which particles must collide so that a reaction occurs. The activation energy for the reaction of magnesium with aqueous hydrogen ions can be determined in the laboratory.

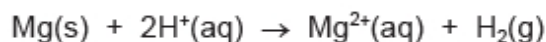

A magnesium strip is placed in dilute hydrochloric acid and the time taken (t), in seconds, for the magnesium to disappear is measured. The initial rate of reaction is calculated as $\frac{1}{\text{time}} \left(\frac{1}{t} \right)$.

If the experiment is repeated at several different temperatures then the following mathematical relationship can be used to calculate E_{A} .

$$\log_{10} \left(\frac{1}{t} \right) = \frac{-E_{\text{A}}}{0.0191} \times \left(\frac{1}{T} \right)$$

T is the temperature measured in K.

$\frac{1}{t}$ is the initial rate of reaction in s^{-1} .

A graph of $\log_{10} \left(\frac{1}{t} \right)$ against $\frac{1}{T}$ can be plotted.

Experimental procedure

1. 25 cm^3 of dilute hydrochloric acid is added to a boiling tube.
2. The boiling tube is placed in a water bath until the dilute hydrochloric acid reaches a constant temperature. This temperature is recorded.
3. A magnesium strip of mass 0.10 g is added to the boiling tube, the mixture stirred and the time taken for the magnesium to disappear is recorded.
4. The temperature of the water bath is changed and the experiment is repeated.

- (a) The results of this experiment, carried out at different temperatures, are recorded in the table below.

Process the results to calculate the reciprocal of temperature $\left(\frac{1}{T}\right)$ and $\log_{10}\left(\frac{1}{t}\right)$. The first value of $\frac{1}{T}$ has been done for you.

Record $\frac{1}{T}$ in **standard form** to **three** significant figures.

Record $\log_{10}\left(\frac{1}{t}\right)$ to **two** decimal places. You should expect $\log_{10}\left(\frac{1}{t}\right)$ to be negative.

temperature /°C	time, t/s	temperature, T/K	$\frac{1}{T}/\text{K}^{-1}$	$\frac{1}{t}/\text{s}^{-1}$	$\log_{10}\left(\frac{1}{t}\right)$
15	83	288	3.47×10^{-3}	1.20×10^{-2}	
20	58	293		1.72×10^{-2}	
27	36	300		2.78×10^{-2}	
30	28	303		3.57×10^{-2}	
34	18	307		5.56×10^{-2}	
38	19	311		5.26×10^{-2}	
40	15	313		6.67×10^{-2}	
43	12	316		8.33×10^{-2}	
48	9	321		1.11×10^{-1}	
55	8	328		1.25×10^{-1}	

[3]

- (b) Plot a graph on the grid on page 7 to show the relationship between $\log_{10}\left(\frac{1}{t}\right)$ and $\frac{1}{T}$.
Use a cross (x) to plot each data point.
Draw a line of best fit.

[2]

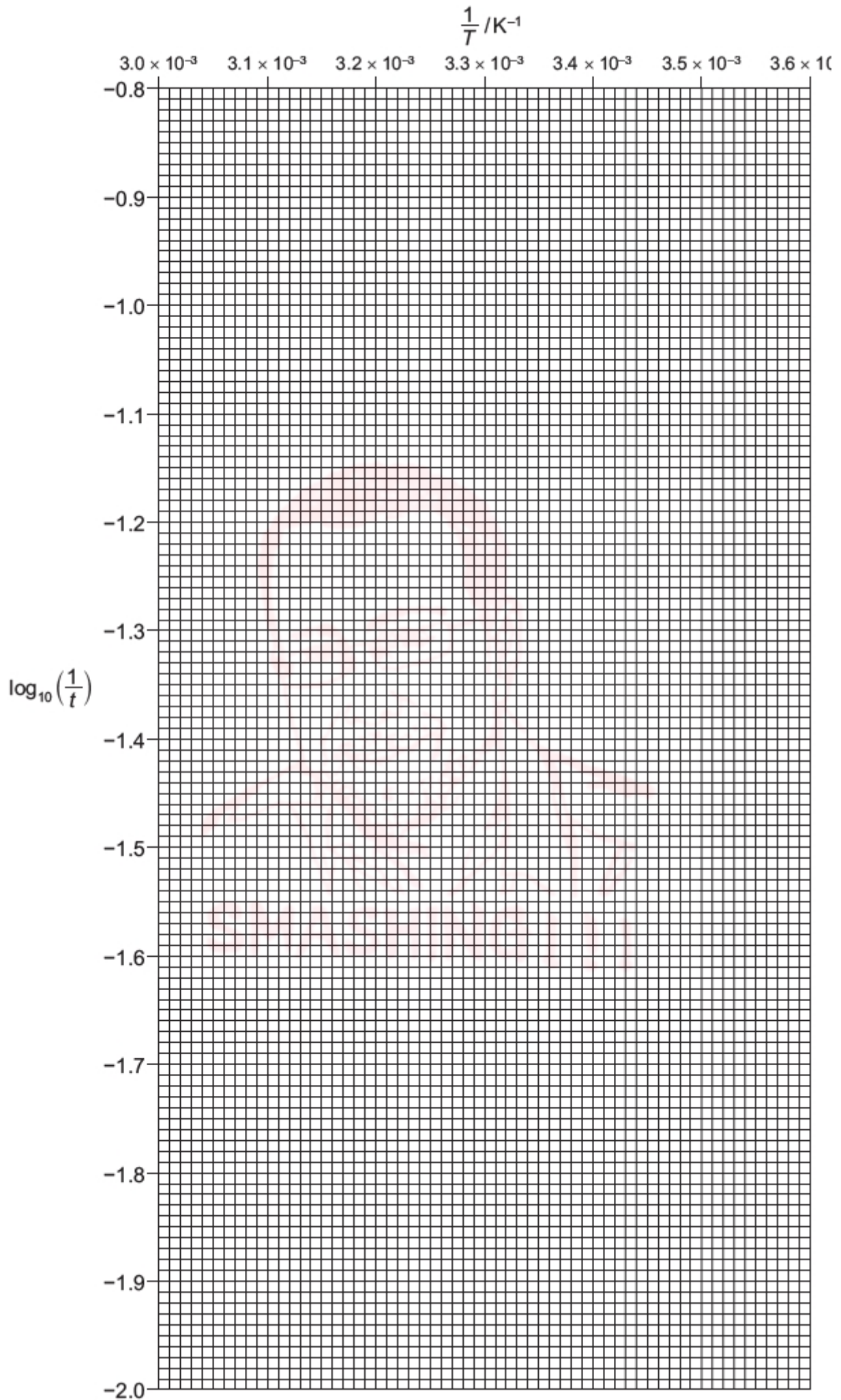

- (c) On your graph, circle the two points you consider to be the most anomalous. Label each one with a different letter. Explain what may have caused each of the anomalies you have identified, giving a different reason each time.

Make it clear in your answer to which point you are referring.

.....
.....
.....
..... [2]

- (d) (i) Determine the gradient of your graph. State the co-ordinates of both points you used for your calculation.

Record the value of the gradient to **three** significant figures.

co-ordinates 1

co-ordinates 2

gradient = [2]

- (ii) Use your gradient from (i) and the mathematical relationship on page 5 to calculate the activation energy, E_A , in kJ mol^{-1} .

Include a sign in your answer.

$E_A = \dots\dots\dots \text{kJ mol}^{-1}$ [2]

- (e) State whether you consider the results to be reliable. Explain your answer.

.....
.....
..... [1]

- (f) Student X commented that data collected at higher temperatures in the experiment may be less accurate than that collected at lower temperatures.

State whether student X is correct. Explain why.

.....
.....
..... [1]

- (g) If the magnesium strip is not stirred it floats to the surface of the hydrochloric acid.

State how this will affect the reaction time. Explain why.

.....
.....
..... [1]

- (h) The experiment in (a) is repeated using dilute ethanoic acid instead of dilute hydrochloric acid. The concentration of both acids is equal. The same temperatures are used as in (a).

State the effect this change in acid will have on the initial rate values. Give a reason for this.

.....
.....
..... [1]

[Total: 15]

- 2 Sucrose, $C_{12}H_{22}O_{11}$, is a naturally occurring sugar found in sugarcane and many fruits. It can be hydrolysed in acidic solution to give glucose and fructose. All three molecules are chiral and will rotate the plane of polarised light. The degree of rotation is known as the **optical rotation**, α .

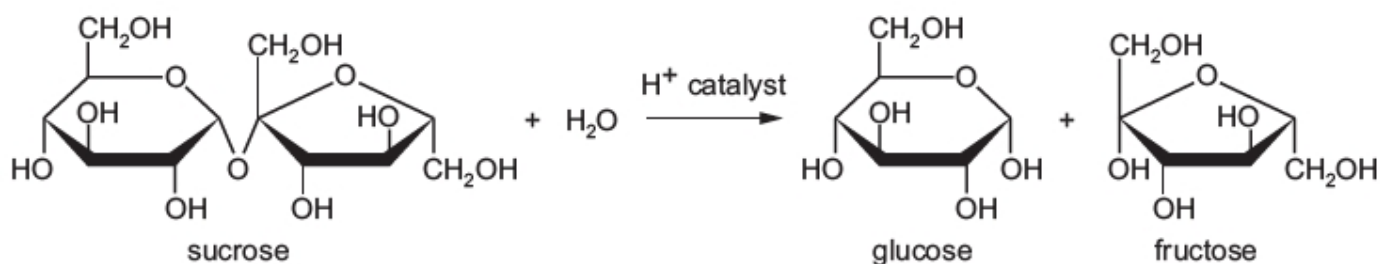

In the presence of excess water, the reaction can be considered to be first order with respect to sucrose concentration.

The progress of the reaction can be monitored using a polarimeter, which measures the optical rotation, α , of the solution. The more concentrated the solution, the greater the optical rotation of the solution.

The concentration of sucrose at time t can be represented as $(\alpha - \alpha_{\text{final}})$, where α_{final} is the optical rotation of the solution after 6 hours.

The mathematical relationship is given by the following equation.

$$\log_{10}(\alpha - \alpha_{\text{final}}) = A - \frac{kt}{2.30}$$

A is a constant.

k is the rate constant.

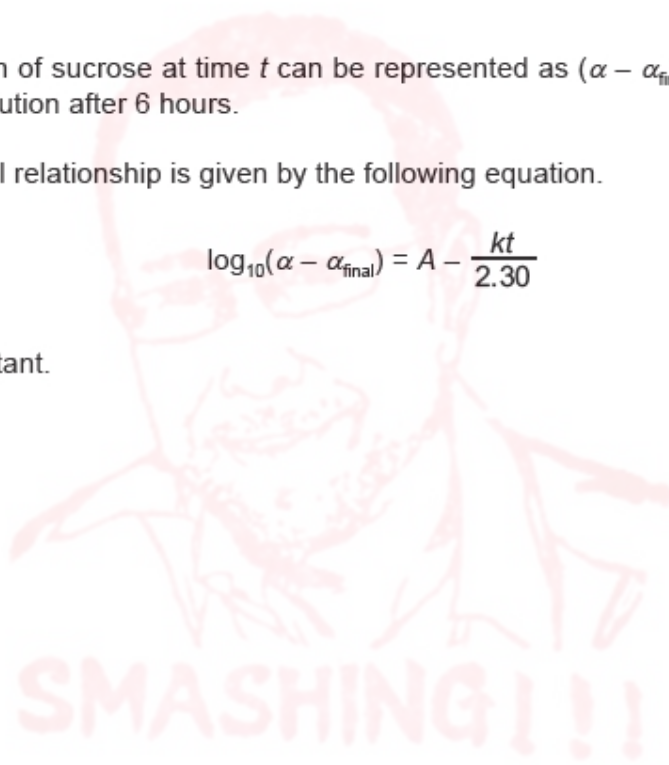

- (a) The experimentally determined values of optical rotation during the hydrolysis of sucrose at 298 K are recorded below.

Process the results to allow you to plot a graph of $\log_{10}(\alpha - \alpha_{\text{final}})$ against time, t .

Calculate $(\alpha - \alpha_{\text{final}})$ and record it to 1 decimal place.

Calculate $\log_{10}(\alpha - \alpha_{\text{final}})$ and record it to 2 decimal places.

time / s	optical rotation, α	$(\alpha - \alpha_{\text{final}})$	$\log_{10}(\alpha - \alpha_{\text{final}})$
0	39.9		
300	29.1		
600	21.3		
900	15.5		
1200	10.6		
1500	6.2		
1800	2.4		
2100	-0.3		
2400	-2.5		
2700	-4.5		

α_{final}	-12.0
-------------------------	-------

[2]

- (b) (i) Plot a graph on the grid on page 9 to show how $\log_{10}(\alpha - \alpha_{\text{final}})$ varies with time, t . Use a cross (x) to plot each data point. Draw the line of best fit.

[2]

- (ii) State and explain whether the results and your graph confirm the relationship $\log_{10}(\alpha - \alpha_{\text{final}}) = A - \frac{kt}{2.30}$.

.....

[1]

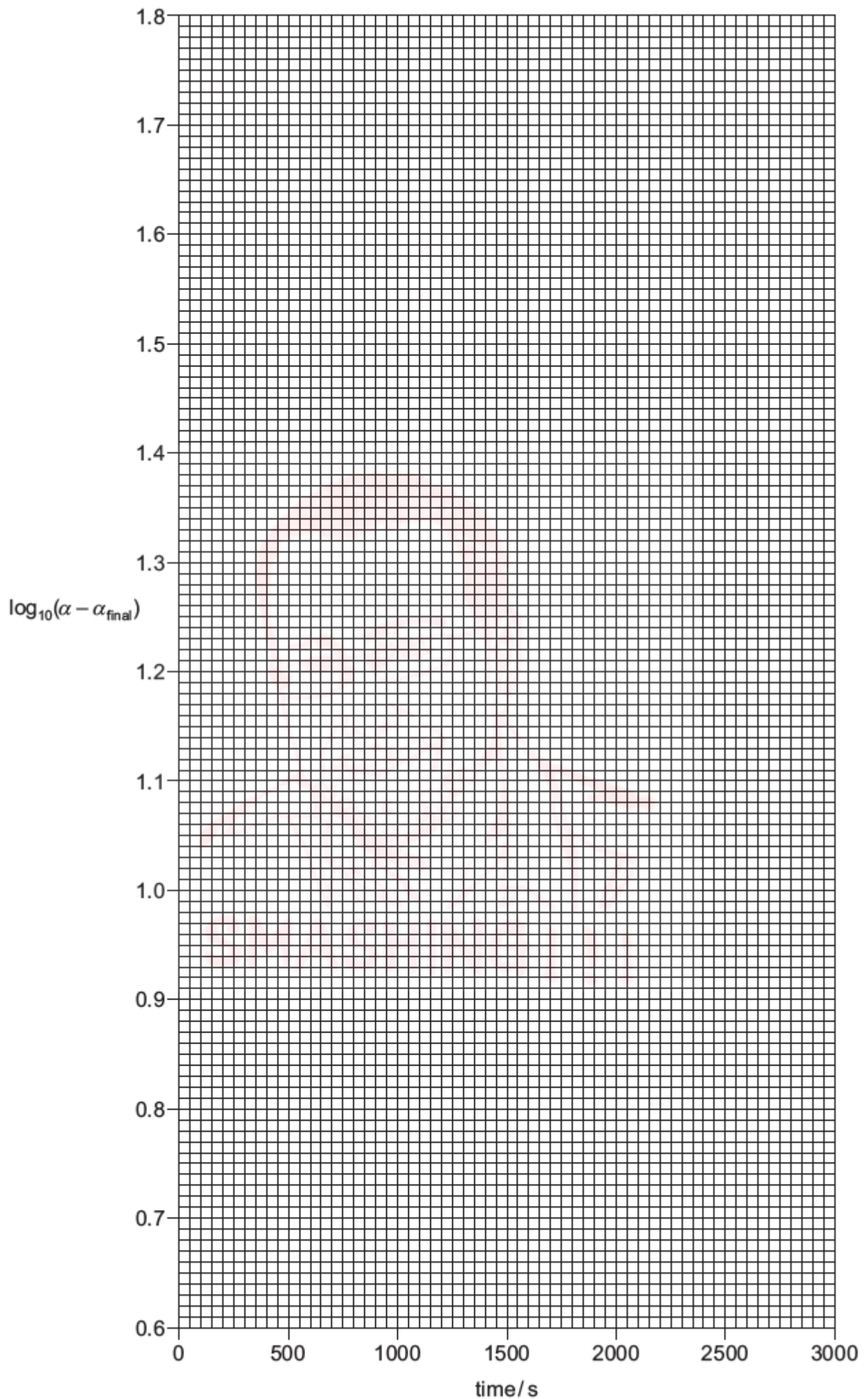

- (c) (i) Determine the gradient of the graph.
State the co-ordinates of both points you used for your calculation.
Record the value of the gradient to **three significant figures**.

co-ordinates 1 co-ordinates 2

gradient = s⁻¹
[2]

- (ii) Use the gradient value to calculate a value for k in the expression shown.

$$\log_{10}(\alpha - \alpha_{\text{final}}) = A - \frac{kt}{2.30}$$

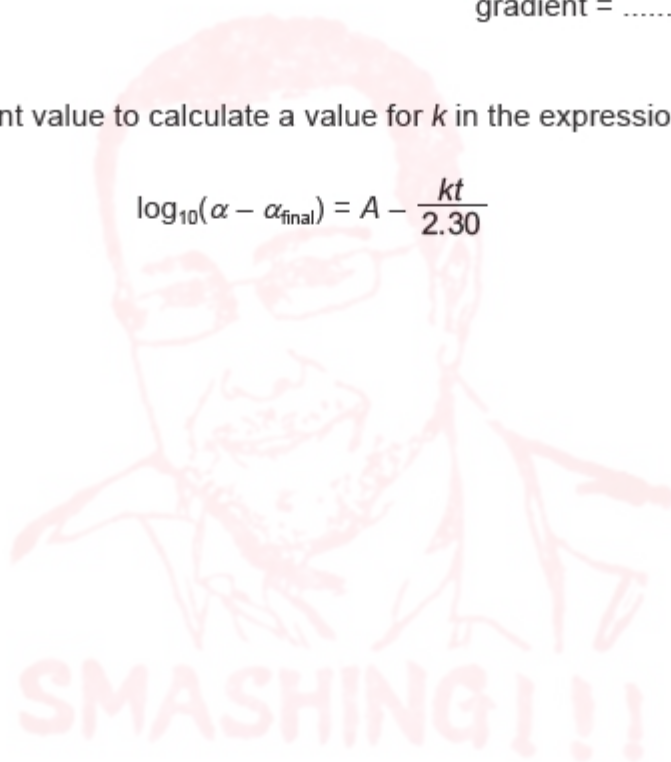

[2]

(d) The graph below shows the results obtained from a second hydrolysis of sucrose reaction performed at a different temperature.

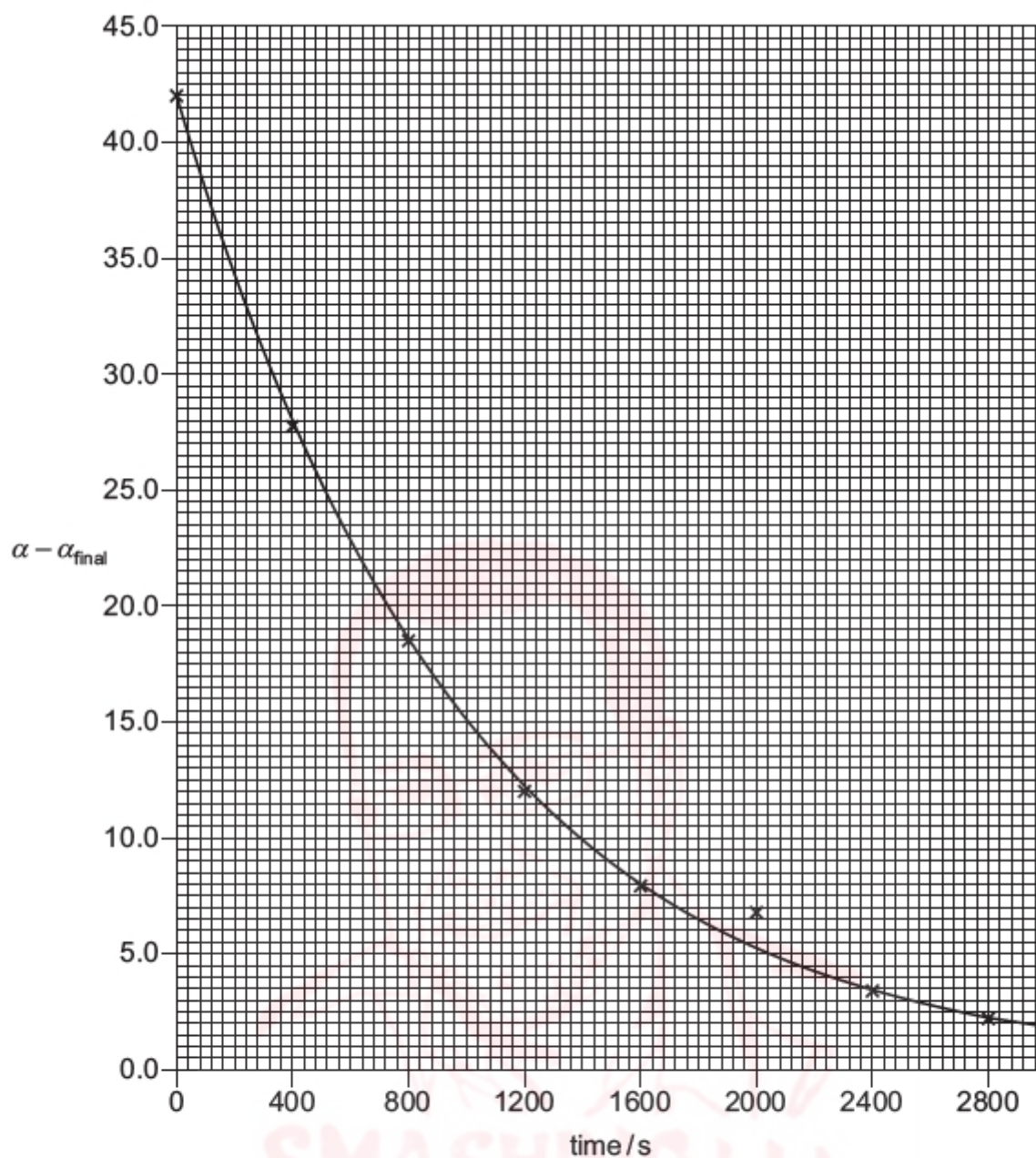

(i) The point at time = 2000 s is considered to be anomalous. Suggest what caused the anomaly.

.....

.....

..... [1]

- (ii) Use the graph to determine the half-life, $t_{1/2}$, of this reaction.
State the co-ordinates of both points you used in your calculation.

co-ordinates 1 co-ordinates 2

half-life = s [2]

- (iii) For a first-order reaction, the following relationship exists.

$$\text{half-life, } t_{1/2} = \frac{0.693}{k'}$$

Use this relationship and your answer to (ii) to determine k' , the rate constant for this second hydrolysis reaction.

If you have been unable to determine the half-life of the reaction in (ii), you may use the value $t_{1/2} = 500$ s, though this is not the correct answer.

$k' = \dots\dots\dots \text{ s}^{-1}$ [1]

- (iv) State whether the temperature of the second reaction was higher or lower than that of the first.

Explain your answer with reference to the answers you obtained in (c)(ii) and (d)(iii).

If you have been unable to calculate a value for k in (c)(ii), you may use the value $k = 8.00 \times 10^{-4}$, though this is not the correct answer.

.....

 [1]

- (v) Would the value of the half-life change if the reaction were repeated with twice the initial concentration of sucrose? Give a reason for your answer.

.....

 [1]

[Total: 15]



2 At temperatures above 5 °C, the benzenediazonium ion, $C_6H_5N_2^+$, reacts with water as shown.

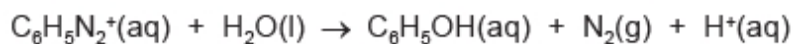

A student investigates this reaction by measuring the volume of nitrogen gas produced at regular time intervals.

The diagram shows the experimental set-up used to investigate this reaction.

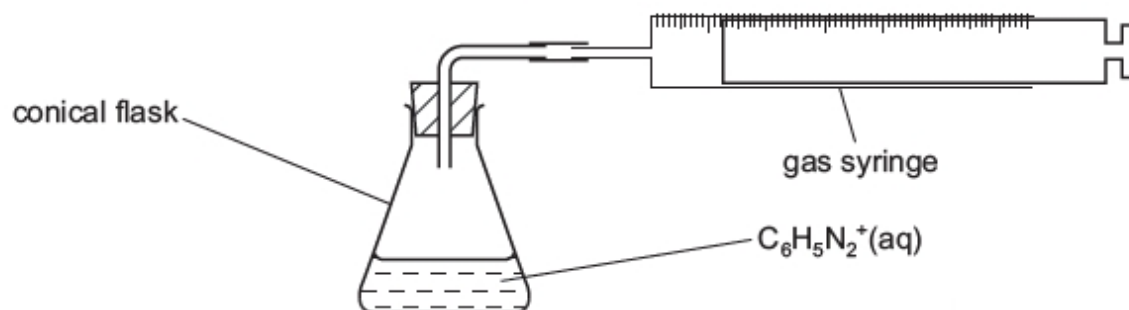

(a) The student finds that the reaction is very slow, so decides to investigate the reaction at 30 °C.

Complete the diagram to show how the student could investigate this reaction at a constant 30 °C. [2]

(b) The student prepared a solution of $C_6H_5N_2^+(aq)$ at $5^\circ C$. A 200.0 cm^3 sample of this solution was placed in a conical flask. The apparatus was allowed to equilibrate at $30^\circ C$. The gas syringe was then connected, a stop-clock was started and readings of time and gas volume were taken. When the decomposition of the $C_6H_5N_2^+$ ion was complete (as shown by no more gas production) the final volume of $N_2(g)$ produced, V_{final} , was 72 cm^3 .

(i) Show by calculation that when the stop-clock was started the concentration of $C_6H_5N_2^+(aq)$ was $0.0150\text{ mol dm}^{-3}$.

[The molar volume of gas under room conditions is 24.0 dm^3 .]

concentration of $C_6H_5N_2^+(aq) = \dots\dots\dots\text{ mol dm}^{-3}$ [2]

(ii) The volume of nitrogen produced is proportional to the amount of $C_6H_5N_2^+$ that reacts. As $C_6H_5N_2^+$ reacts, its concentration in the solution falls.

Using the axes shown, sketch a graph to show the change in volume of $N_2(g)$ produced with the change in concentration of $C_6H_5N_2^+(aq)$.

Label the axes $[C_6H_5N_2^+(aq)]/\text{mol dm}^{-3}$ and volume of $N_2(g)/\text{cm}^3$, putting the independent variable on the x-axis.

Include on the axes the maximum values for concentration and volume where the lines on the axes are shown.

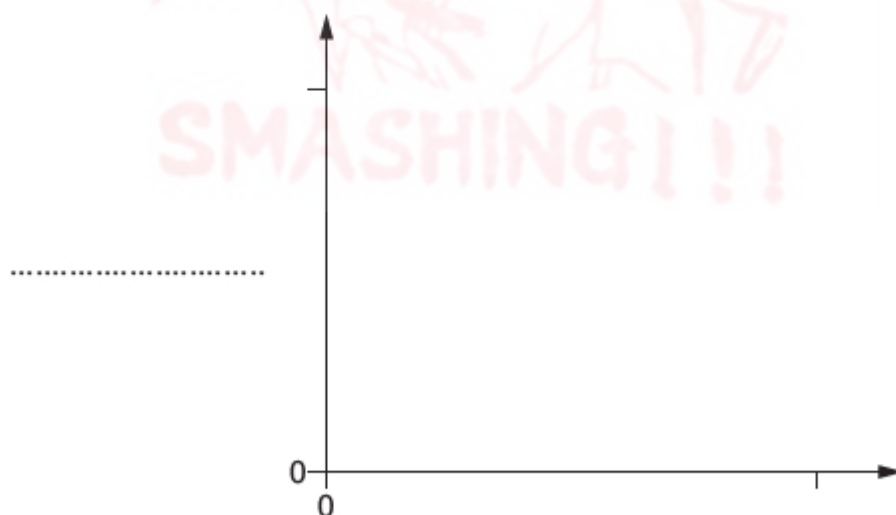

[2]



(c) The results the student obtained are shown in the table.

To calculate the concentration of $C_6H_5N_2^+(aq)$ the student used the following equation.

$$[C_6H_5N_2^+(aq)] = 0.0150 \times \left(1 - \frac{V}{V_{\text{final}}}\right)$$

V = volume of $N_2(g)$ recorded at a specified time.

V_{final} = final volume of $N_2(g)$ at complete decomposition of $C_6H_5N_2^+$.

V_{final} is 72 cm^3 .

Complete columns **C** and **D** to **three** significant figures. You may use the space below for any working.

A	B	C	D
time / minutes	volume of $N_2(g)$, V/cm^3	$\frac{V}{V_{\text{final}}}$	$[C_6H_5N_2^+(aq)]/\text{mol dm}^{-3}$
0.0	0	0.000	0.0150
2.0	9	0.125	$0.0150 \times (1 - 0.125) = 0.0131$
4.0	17		
6.0	24		
8.0	30		
10.0	35		
12.0	40		
14.0	44		
16.0	48		

[2]

- (d) Plot a graph on the grid to show the relationship between $[\text{C}_6\text{H}_5\text{N}_2^+(\text{aq})]$ and time. Use a cross (x) to plot each data point. Draw a line of best fit.

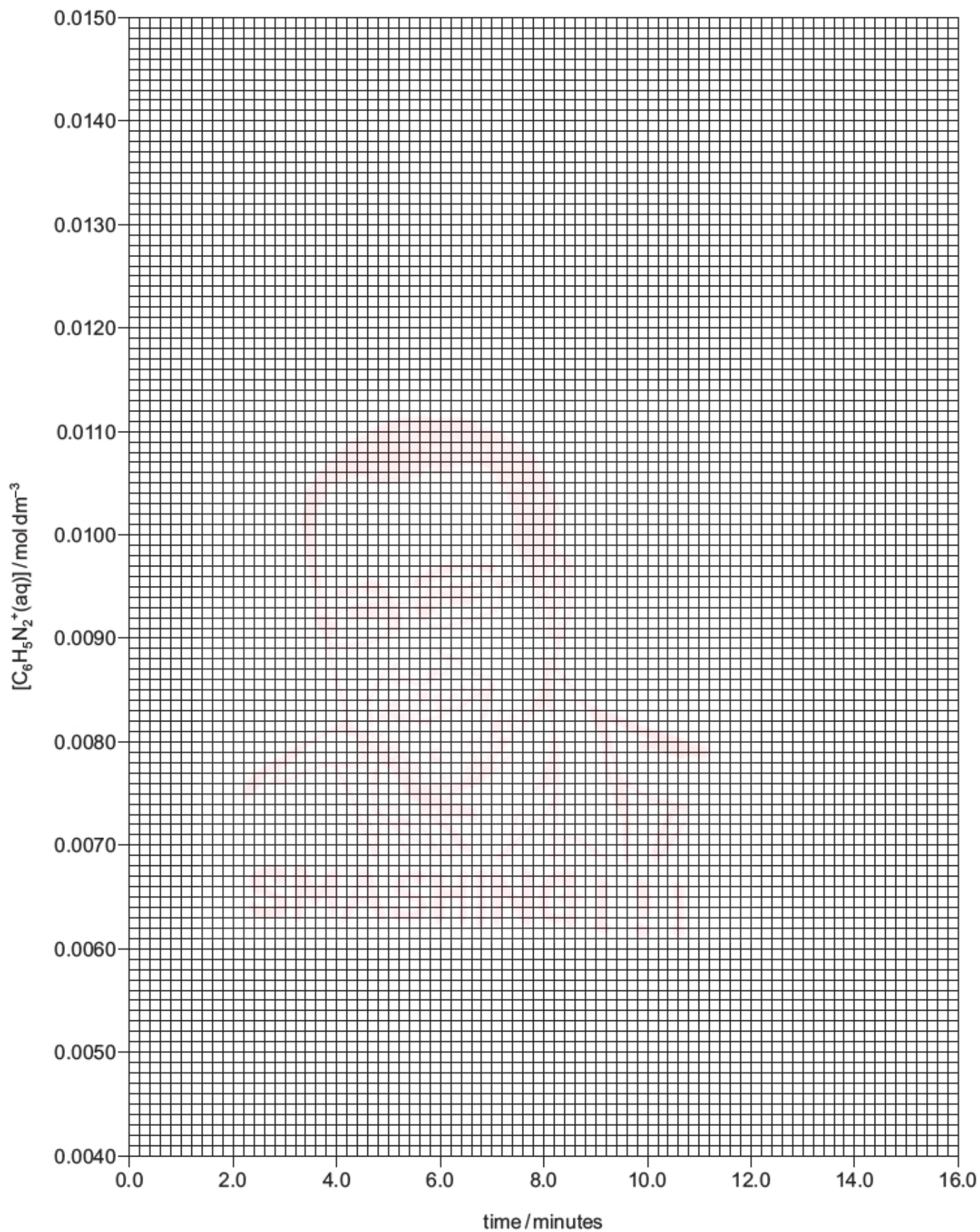

[2]

- (e) Draw a tangent at time = 0.0 on your graph and use the tangent to determine the initial rate of reaction. State the units of the initial rate of reaction.

State the co-ordinates of both points you used in your calculation.

co-ordinates 1 co-ordinates 2

initial rate of reaction =

units =

[4]

- (f) Use your graph to complete the table and calculate the values of two half-lives. For the first half-life, concentrations have been chosen for you.

concentration 1	time 1	concentration 2	time 2	$t_{\frac{1}{2}}$
0.0120	0.0060
.....

[3]

- (g) State and explain what the values of the two half-lives suggest about the order of reaction with respect to $[C_8H_5N_2^+(aq)]$.

.....

..... [1]

[Total: 18]

1 The Finkelstein reaction is a nucleophilic substitution reaction in which a halogen atom in a halogenoalkane is replaced by another halogen atom. The reaction is carried out using dry propanone as a solvent.

One example of the Finkelstein reaction is given.



(a) (i) Explain why it is important for **dry** propanone to be used as a solvent for this reaction.

.....

.....

..... [1]

(ii) The solubilities of NaBr and NaI in propanone are shown.

compound	solubility at 25 °C in g/ 100 g of propanone
NaBr	0.00841
NaI	39.9

Use this information to explain why, although the reaction between CH₃CH₂CH₂Br and NaI is reversible, the reaction produces a very high yield.

.....

.....

.....

.....

.....

.....

..... [2]



(b) Some safety information for the organic compounds used in this reaction is shown.

- 1-bromopropane is **highly flammable** and **moderate health hazard**. It is irritating to eyes, the respiratory system and skin.
- 1-iodopropane is **flammable** and **moderate health hazard**. It is irritating to eyes, the respiratory system and skin.
- Propanone is **highly flammable** and **moderate health hazard**. It is irritating to eyes, and may cause dizziness and drowsiness.

Identify **two** different precautions, other than using protective equipment such as gloves, a lab coat or eye protection, that should be taken when carrying out this experiment. Explain each answer.

1 precaution

.....

explanation

.....

2 precaution

.....

explanation

.....

[2]

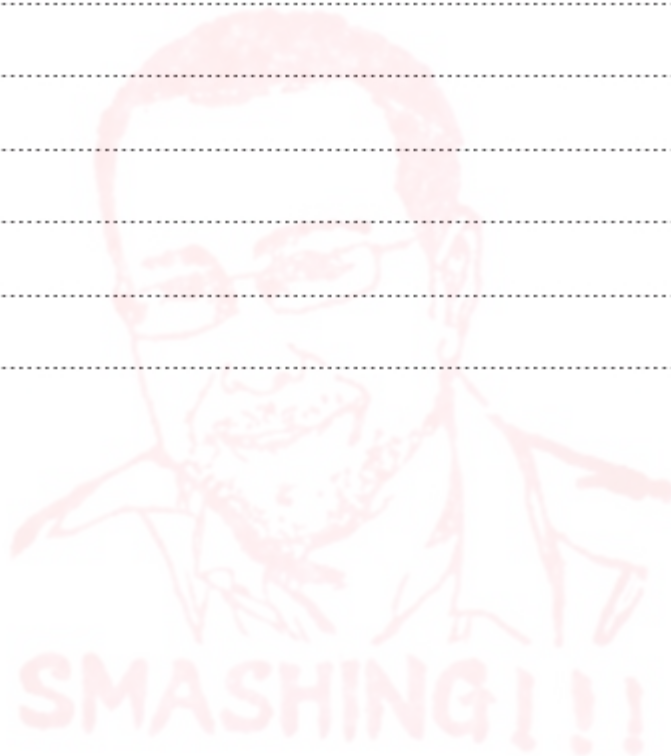

- (c) A student plans an experiment to show that the rate of the reaction is proportional to the concentration of NaI.

Propanone is used as the solvent in this reaction.

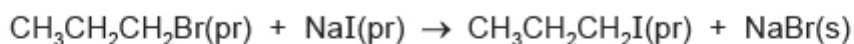

(pr) = substance is dissolved in propanone

The student plans to record the time it takes for the solid formed to obscure a cross on a piece of paper below the conical flask, as shown.

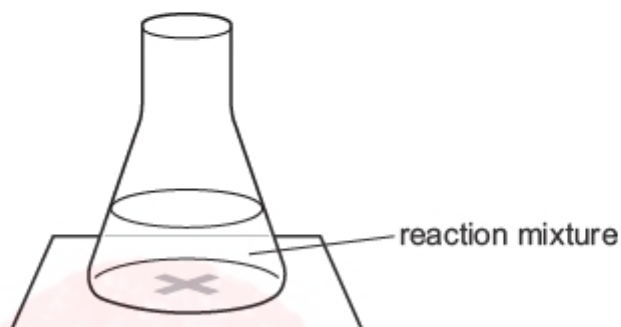

To carry out this experiment, the following materials are available.

- $\text{CH}_3\text{CH}_2\text{CH}_2\text{Br}(\text{l})$
 - $\text{NaI}(\text{s})$
 - dry propanone, $\text{CH}_3\text{COCH}_3(\text{l})$
 - usual laboratory apparatus
- (i) Calculate the masses of $\text{NaI}(\text{s})$ and $\text{CH}_3\text{COCH}_3(\text{l})$ that would be needed to make 150 cm^3 of 0.50 mol dm^{-3} $\text{NaI}(\text{pr})$. Assume 150 cm^3 of propanone are required. Give your answers to **one decimal place**.

The density of $\text{CH}_3\text{COCH}_3(\text{l})$ is 0.79 g cm^{-3} .

[A_r : Na, 23.0; I, 126.9]

mass of $\text{NaI}(\text{s}) = \dots\dots\dots\text{ g}$

mass of $\text{CH}_3\text{COCH}_3(\text{l}) = \dots\dots\dots\text{ g}$
[2]

(ii) Part of the table the student used to record data is given.

Complete the table with appropriate volumes that the student could have used in four further experiments.

volume of 0.50 mol dm^{-3} $\text{NaI}(\text{pr}) / \text{cm}^3$	volume of $\text{CH}_3\text{CH}_2\text{CH}_2\text{Br}(\text{l}) / \text{cm}^3$	volume of $\text{CH}_3\text{COCH}_3(\text{l}) / \text{cm}^3$	total volume $/ \text{cm}^3$	time $/ \text{s}$
10.0	2.0	30.0	42.0	

[2]

(iii) The student uses the same experimental set-up each time.

In this experiment, identify the dependent variable.

..... [1]

(iv) Write an expression to show how the student could calculate the rate of the reaction.

[1]

(v) Identify the major source of inaccuracy of measurement in this reaction.

Suggest an improvement to the experiment to make it more accurate.

inaccuracy

.....

improvement

..... [2]

(d) The reaction between $\text{CH}_3\text{CH}_2\text{CH}_2\text{Br}$ and NaI proceeds via an $\text{S}_{\text{N}}2$ mechanism.

The student repeated the experiment in (c) using an isomer of $\text{CH}_3\text{CH}_2\text{CH}_2\text{Br}$ that reacts via both $\text{S}_{\text{N}}1$ and $\text{S}_{\text{N}}2$ mechanisms.

State and explain whether the student will be able to show that the rate of this reaction is proportional to the concentration of NaI .

.....

.....

.....

..... [1]

[Total: 14]



- 1** The reaction between hydrogen peroxide, $\text{H}_2\text{O}_2(\text{aq})$, and iodide ions, $\text{I}^-(\text{aq})$, takes place in acidic conditions.



The rate of this reaction can be found by measuring the time taken for a given amount of iodine, $\text{I}_2(\text{aq})$, to form.

This is done by adding a known amount of thiosulfate ions, $\text{S}_2\text{O}_3^{2-}(\text{aq})$, and allowing the $\text{I}_2(\text{aq})$ formed in **reaction 1** to react with the $\text{S}_2\text{O}_3^{2-}(\text{aq})$.

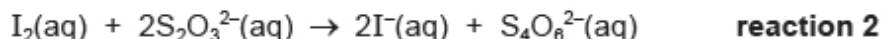

After the $\text{S}_2\text{O}_3^{2-}(\text{aq})$ ions have all reacted in **reaction 2**, any further $\text{I}_2(\text{aq})$ formed in **reaction 1** can be detected using an indicator.

A student carried out a series of experiments to determine the order of reaction with respect to the concentration of $\text{I}^-(\text{aq})$ ions in **reaction 1**.

The student prepared the following solutions.

solution **A** $0.100 \text{ mol dm}^{-3} \text{ KI}(\text{aq})$

solution **B** $0.0500 \text{ mol dm}^{-3} \text{ Na}_2\text{S}_2\text{O}_3(\text{aq})$

The student also had access to the following chemicals.

solution **C** $0.100 \text{ mol dm}^{-3} \text{ H}_2\text{O}_2(\text{aq})$

$0.2 \text{ mol dm}^{-3} \text{ H}_2\text{SO}_4(\text{aq})$

distilled water

a suitable indicator

- (a)** The student prepared solution **A** in a 250 cm^3 volumetric flask.
- (i)** The student used a balance accurate to two decimal places and a weighing boat. A weighing boat is a small container used to hold solid samples when they are weighed.

Determine the mass, in g, of KI needed to prepare 250.0 cm^3 of solution **A**.

[A_r : K, 39.1; I, 126.9]

mass = g [2]



- (ii) The student weighed the empty weighing boat. The student then added solid KI to the weighing boat until the mass of KI calculated in (i) was reached. The student transferred all of the KI from the weighing boat into a 100 cm³ beaker.

Describe how the student could check that the mass of KI transferred into the 100 cm³ beaker was exactly the same as the mass calculated in (i).

.....
..... [1]

- (iii) The student dissolved the KI in the 100 cm³ beaker in distilled water and transferred the solution formed into a 250 cm³ volumetric flask. Distilled water was added to the volumetric flask until the volume of the solution was exactly 250 cm³. Care was taken to avoid parallax errors.

Describe:

- how the student should transfer all the KI solution from the beaker into the 250 cm³ volumetric flask
- how the student should fill the volumetric flask exactly up to the 250 cm³ mark.

.....
.....
.....
..... [2]

- (b) The student rinsed a burette with solution A before filling it with solution A.

Explain why this improves the accuracy of the results.

.....
..... [1]

- (c) The student was given a solution of 0.400 mol dm⁻³ Na₂S₂O₃(aq).

Determine the volume, in cm³, of this solution that should be added to a 100 cm³ volumetric flask to prepare 100.0 cm³ of solution B. Give your answer to **two** decimal places.

volume = cm³ [1]

(d) Experiment 1 was carried out using a series of steps.

- step 1** The student used a measuring cylinder to measure 25 cm^3 of $0.2\text{ mol dm}^{-3}\text{ H}_2\text{SO}_4(\text{aq})$. This was transferred to a conical flask.
- step 2** The student added 20.00 cm^3 of distilled water from a burette to the conical flask.
- step 3** The student added 5.00 cm^3 of solution **A** from a burette to the conical flask.
- step 4** The student added 5.00 cm^3 of solution **B** from a burette to the conical flask.
- step 5** The student added 1.0 cm^3 of indicator from a teat pipette to the conical flask.
- step 6** The student used a burette to add 10.00 cm^3 of solution **C** to a small beaker. The contents of the beaker were added to the conical flask and a stopclock was started immediately. The stopclock was stopped when the I_2 formed caused the indicator to change colour.

In Experiments 2–6 the student repeated **steps 1–6** but using the volumes of distilled water and solution **A** given in the table.

The student carried out two trials of each experiment.

experiment	volume of $\text{H}_2\text{SO}_4(\text{aq})$ / cm^3	volume of distilled water / cm^3	volume of solution A , v / cm^3	volume of solution B / cm^3	volume of indicator / cm^3	time for the indicator to change colour, t / s	
						trial 1	trial 2
1	25.0	20.00	5.00	5.00	1.0	218	220
2	25.0	15.00	10.00	5.00	1.0	112	113
3	25.0	12.50	12.50	5.00	1.0	100	
4	25.0	10.00	15.00	5.00	1.0	77	76
5	25.0	5.00	20.00	5.00	1.0	59	59
6	25.0	0.00	25.00	5.00	1.0	47	49

- (i) In Experiment 3, trial 2, the indicator changed colour as soon as the student added solution **C** to the conical flask. No results were recorded for Experiment 3, trial 2.

Suggest which step the student did **not** carry out in Experiment 3, trial 2.

..... [1]

- (ii) Suggest why the results shown in the table could be considered reliable.

.....
..... [1]

(iii) What was the percentage error in the burette reading for measuring the volume of solution **A** in Experiment 5?

percentage error = % [1]

(iv) Suggest why a measuring cylinder was used to measure the volume of $\text{H}_2\text{SO}_4(\text{aq})$ rather than a more accurate piece of apparatus, such as a burette.

..... [1]

(v) For Experiments 1–6, state:

- the independent variable
- the dependent variable.

[2]



(e) The rate equation can be written as $\text{rate} = k[\text{I}^-]^n$ where $[\text{I}^-]$ is proportional to the volume of solution **A** and n is the order of reaction with respect to I^- .

(i) Use only the results of Experiments 1–6 given in (d) to complete the table where:

- v is the volume of solution **A** used in cm^3
- t_{av} is the average time taken in trial 1 and trial 2 in s.

Give all values to **three** significant figures.

experiment	v/cm^3	$\log v$	t_{av}/s	$(1/t_{\text{av}})/\text{s}^{-1}$	$\log(1/t_{\text{av}})$
1	5.00				
2	10.00				
3	12.50		100	0.0100	
4	15.00				
5	20.00				
6	25.00				

[2]

(ii) Rate can be expressed as $(1/t_{\text{av}})$.
The rate equation can be expressed as shown.

$$\log(1/t_{\text{av}}) = n \log v + c$$

where:

- c is a constant
- v is proportional to $[\text{I}^-]$.

On the grid:

- Plot a graph of $\log(1/t_{\text{av}})$ against $\log v$. Use a cross (x) to plot each data point.
- Draw a line of best fit.

[2]

(iii) Use your graph to determine the gradient of the line of best fit. State the coordinates of both points you used in your calculation. Give the gradient to **three** significant figures. Determine the order of reaction with respect to $\text{I}^-(\text{aq})$.

co-ordinates 1 co-ordinates 2

gradient =

order of reaction with respect to $\text{I}^-(\text{aq}) = \dots\dots\dots$

[3]



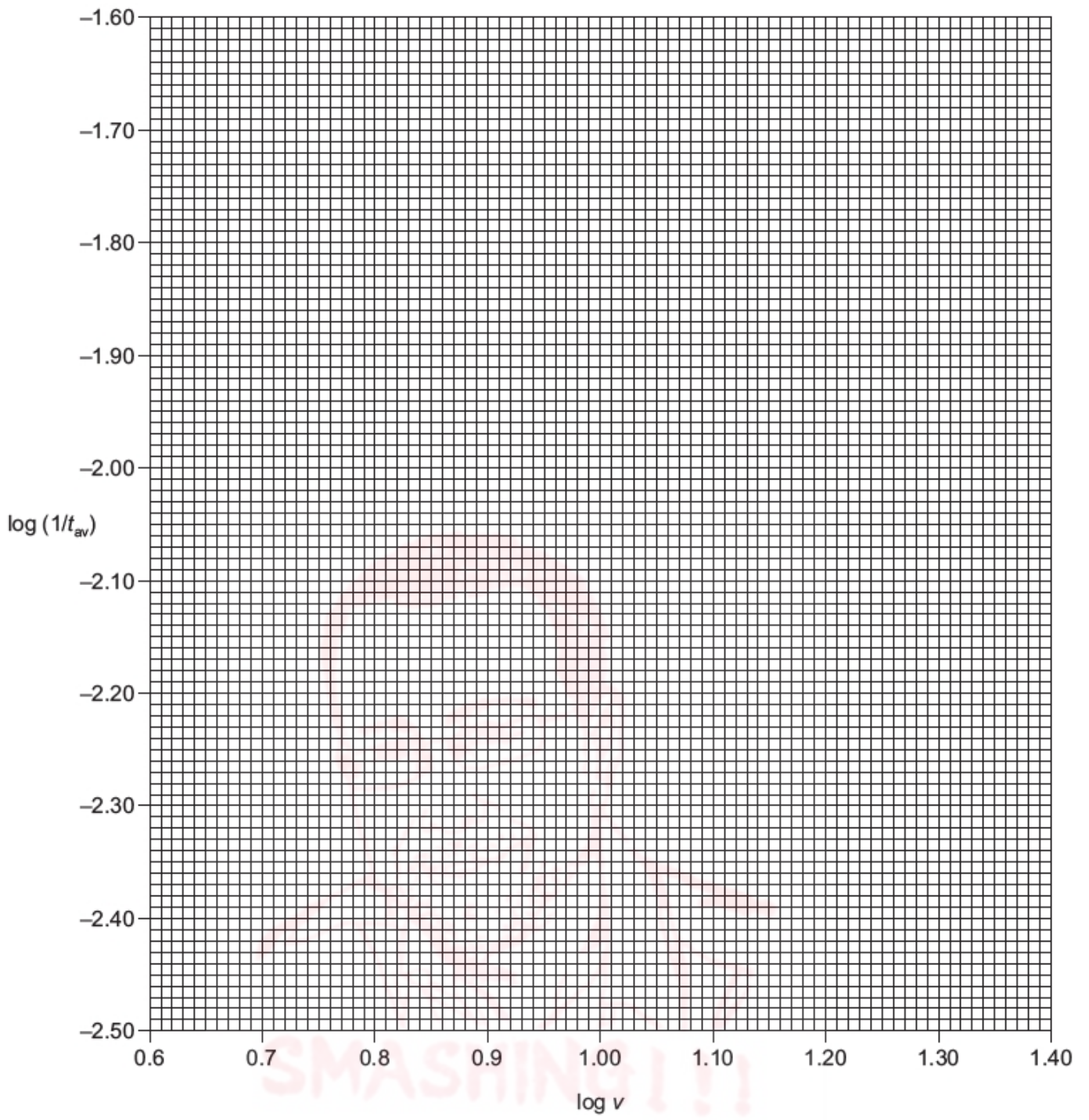

[Total: 20]



2 The rate of reaction between calcium carbonate, CaCO_3 , and hydrochloric acid, HCl , can be followed by collecting and measuring the volume of carbon dioxide produced at 30-second intervals.

The equation for the reaction is:



(a) A student plans to collect the carbon dioxide by displacement of water.

Draw a labelled diagram of the apparatus that could be used to carry out this experiment.

The apparatus should allow the accurate recording of the volume of carbon dioxide produced.



[3]

- (b) The student carried out the investigation using an excess of calcium carbonate with dilute hydrochloric acid. The student stopped timing after 330 seconds had passed. The volume of carbon dioxide produced was 93 cm^3 .

V_{final} is the final volume of carbon dioxide collected at 330 seconds.

V_t is the volume of carbon dioxide collected at each interval of time, t .

$V_{\text{final}} - V_t$ is proportional to the concentration of hydrochloric acid at a given time.

time, t/s	volume of carbon dioxide collected / cm^3	$V_{\text{final}} - V_t / \text{cm}^3$
0	0	
30	22	
60	37	
90	50	
120	61	
150	68	
180	75	
210	78	
240	79	
270	87	
300	90	
330	93	

- (i) Complete the table.

[1]

(ii) Plot a graph of $V_{\text{final}} - V_t$ (y-axis) against time, t (x-axis).

Use a cross (x) to plot each data point. Draw a curved line of best fit.

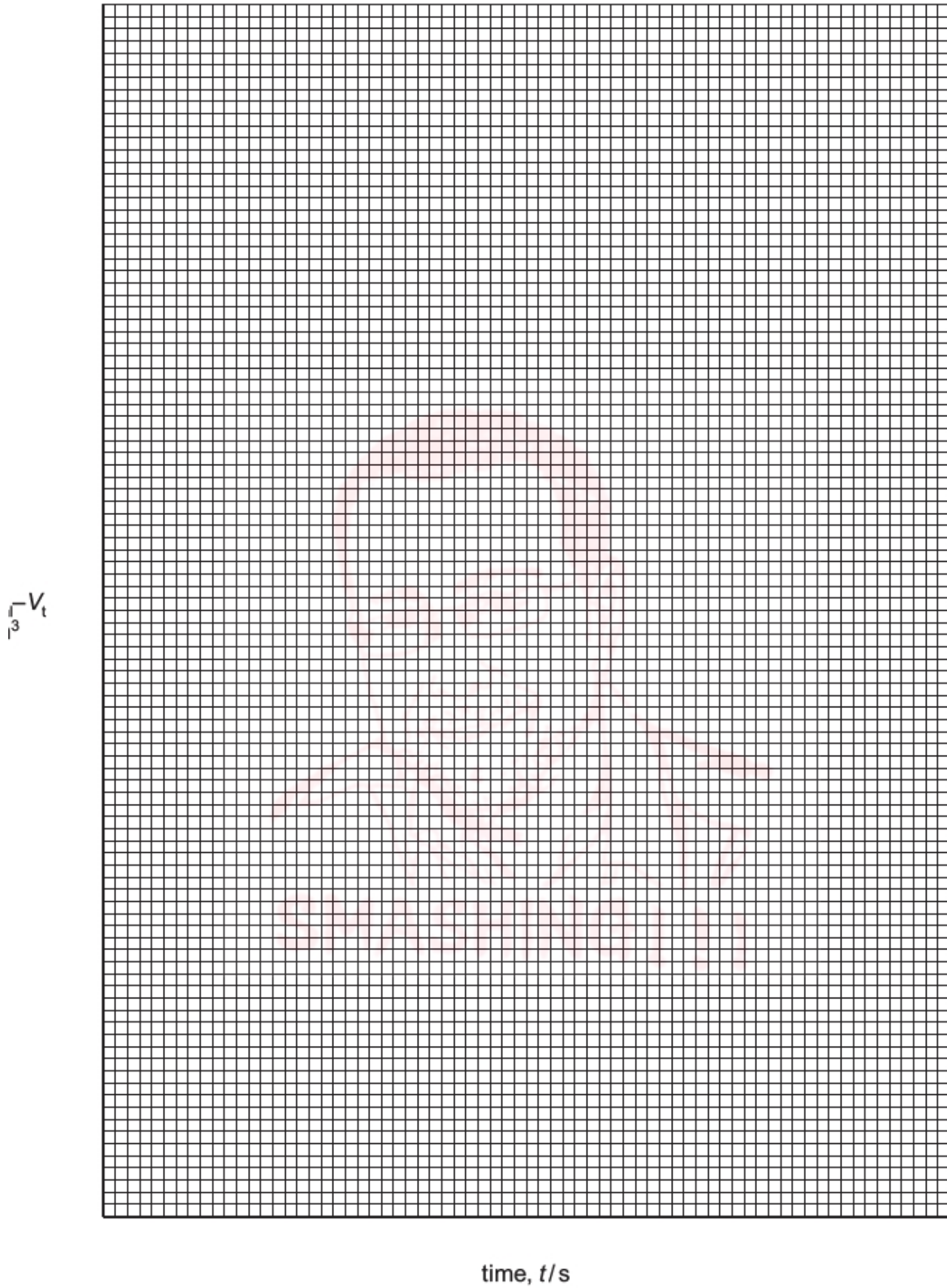

(iii) Circle the point which you consider to be most anomalous.

[2]

[1]



(iv) Suggest **one** reason for this anomalous point.

.....
..... [1]

(v) Draw construction lines on the graph to calculate two consecutive half-lives for this reaction. Use these half-lives to determine the mean half-life, $t_{\frac{1}{2}}$.

first half-life = s

second half-life = s

mean half-life, $t_{\frac{1}{2}}$ = s [2]

(vi) The rate constant, k , for this reaction can be calculated using the following expression.

$$t_{\frac{1}{2}} = \frac{0.693}{k}$$

Calculate k .

If you did not obtain a value for $t_{\frac{1}{2}}$ in (v) you may use 95 seconds. This is **not** the correct answer.

k = s⁻¹ [1]

(c) State how an increase in temperature would affect the value of k for this reaction. Explain your answer.

.....
..... [1]



(d) Calcium carbonate is a component of antacid tablets.

An alternative method of studying the rate of reaction between calcium carbonate and hydrochloric acid is:

- Place one antacid tablet into a beaker.
- Add 50 cm³, **an excess**, of 2.0 mol dm⁻³ hydrochloric acid and start the stop-clock immediately.
- Record the time taken for the fizzing to stop.

(i) An antacid tablet typically contains 1.0 g of CaCO₃.

Complete columns A, B and C in the table to show four more concentrations of **excess** HCl(aq) which would allow this method to be carried out.

Each sample of HCl(aq) must be made by dilution of 2.0 mol dm⁻³ HCl.

[A, Ca, 40.1; C, 12.0; O, 16.0]

A	B	C	D
volume of 2.0 mol dm ⁻³ HCl / cm ³	volume of distilled water / cm ³	concentration of HCl / mol dm ⁻³	time taken for fizzing to stop / s
50.0	0.0	2.0	

[2]

(ii) Identify the dependent variable in this investigation.

..... [1]

(iii) Suggest how the reliability of the results could be improved.

.....
..... [1]

[Total: 16]

Titration

Topic Chem 4 Titration Q# 24/ ALVI Chemistry/2005/w/TZ 1/ Paper 5/Q# 1/www.SmashingScience.org

EXPERIMENT Required, no longer needed from 2007 onwards.

- 1 **FB 1** is $0.200 \text{ mol dm}^{-3}$ propanoic acid, $\text{C}_2\text{H}_5\text{CO}_2\text{H}$.
FB 2 is $0.100 \text{ mol dm}^{-3}$ sodium hydroxide, NaOH .
S is an organic liquid which is immiscible (forms two separate layers) with water.

On shaking **FB 1** with the solvent **S**, propanoic acid is transferred from the aqueous layer to the organic layer until equilibrium is reached.

You are to investigate this equilibrium in the following experiments.

(a) Preparation of the equilibrium mixtures

Experiment A

Use a measuring cylinder to place 50 cm^3 of **FB 1** into the stoppered conical flask labelled **A**.

Use the measuring cylinder to add 20 cm^3 of **S** to the flask and replace the stopper.

Experiment B

Use the measuring cylinder to place 50 cm^3 of **FB 1** into the stoppered conical flask labelled **B**.

Use the measuring cylinder to add 40 cm^3 of **S** into the flask and replace the stopper.

Shake the flasks vigorously for 3 minutes, then leave to stand.

START YOUR ANSWER TO QUESTION 2, but shake the flasks vigorously for 1 minute after each 5 minutes, returning to Question 1 after a minimum of 15 minutes or when you have completed Question 2. You are attempting to establish an equilibrium mixture of propanoic acid dissolved in water and in solvent **S** in each flask.

One of the two following equilibrium mixtures is established.

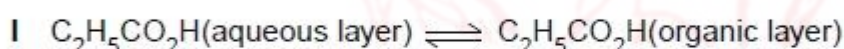

$$\text{For this equilibrium, } K_c = \frac{[\text{C}_2\text{H}_5\text{CO}_2\text{H}(\text{organic layer})]}{[\text{C}_2\text{H}_5\text{CO}_2\text{H}(\text{aqueous layer})]}$$

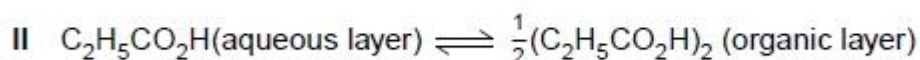

$$\text{For this equilibrium, } K_c = \frac{\sqrt{[\text{C}_2\text{H}_5\text{CO}_2\text{H}(\text{organic layer})]}}{[\text{C}_2\text{H}_5\text{CO}_2\text{H}(\text{aqueous layer})]}$$

You are to determine which of the two K_c expressions is supported by the results of your experiment.



(b) Titration of Flask A

Allow the layers to separate after the final shake. Fill the burette with **FB 2**. Tilt the flask and carefully pipette 10 cm^3 of the **lower** (aqueous) layer into a titration flask. Place your finger over the top of the pipette, or fit pipette filter if available, before lowering into the solution. This will minimise the amount of the top layer that enters the pipette. Withdraw 10 cm^3 of the lower layer.

Add two drops of phenolphthalein indicator and titrate with **FB 2** until a faint permanent pink colour is obtained.

Repeat the titration two more times and record the results of each titration in Table 1.1 below.

Table 1.1 Titration of Flask A

final burette reading / cm^3			
initial burette reading / cm^3			
volume of FB 2 used / cm^3			

[3] + [3]

Summary

10 cm^3 of the aqueous layer in Flask **A** react with cm^3 of **FB 2**.

Show which results you used to obtain this volume of **FB 2** by placing a tick (✓) under the readings in Table 1.1.

(c) Titration of Flask B

Titrate three 10 cm^3 portions of the **lower** (aqueous) layer in the same way as for Flask **A**.

Record the results of each titration in Table 1.2 below.

Table 1.2 Titration of Flask B

final burette reading / cm^3			
initial burette reading / cm^3			
volume of FB 2 used / cm^3			

[1] + [2]

Summary

10 cm^3 of the aqueous layer in Flask **B** react with cm^3 of **FB 2**.

Show which results you used to obtain this volume of **FB 2** by placing a tick (✓) under the readings in Table 1.2.

You are advised to show full working in all parts of the calculations.

- (d) Calculate how many moles of propanoic acid were contained in 50 cm³ of **FB 1**.

[1]

- (e) For each flask, calculate how many moles of propanoic acid remain in 50 cm³ of the aqueous layer after shaking with solvent **S**.

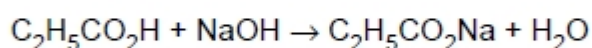

Flask A	Flask B

[1]

- (f) For each flask, calculate how many moles of propanoic acid have transferred to the organic layer **S**.

Flask A	Flask B

[1]

- (g) For each flask, calculate the concentration, in mol dm⁻³, of propanoic acid in the aqueous layer.

Flask A	Flask B

[1]



- (h) For each flask, calculate the concentration, in mol dm^{-3} , of propanoic acid in the organic layer **S**.

Flask A	Flask B

[2]

- (i) Use your results to (g) and (h) to investigate which of the K_c expressions, I or II on page 2, is correct.

Equation is correct.

[2]

- (j) Suggest **two** reasons why the calculated values for K_c may still vary even when the correct equilibrium expression is used.

Reason 1

.....

Reason 2

..... [2]

- (k) The concentration of propanoic acid in the organic layer can be determined by direct titration. 10 cm^3 of the organic layer is pipetted into a titration flask. 15 cm^3 of distilled water is added and the mixture is titrated with **FB 2**, shaking between each addition of **FB 2**. Suggest why the 15 cm^3 of distilled water is added to the titration flask.

.....

..... [1]

[Total: 20]

EXPERIMENT Required, no longer needed from 2007 onwards.

- 1 **FB 1** is 0.02 mol dm^{-3} potassium manganate(VII), KMnO_4 .
FB 2 is a solution containing iron(II) ions, Fe^{2+} .
FB 3 is an aqueous solution of a substance, **X**.

Under acid conditions **X** oxidises iron(II) to iron(III).

You are required to determine

- the concentration of iron(II) ions in **FB 2** and, by a graphical method,
- the volume of **FB 3** that will oxidise the iron(II) ions in 25.0 cm^3 of **FB 2**.

(a) *Experiment 1*

Fill a burette with potassium manganate(VII), **FB 1**.

Pipette 25.0 cm^3 of **FB 2** into a conical flask and add, using the measuring cylinder provided, 10 cm^3 of 1 mol dm^{-3} sulphuric acid.

Run **FB 1** from the burette into the conical flask until the first permanent pale pink colour remains. This is the end point of the titration.

Record your burette readings in Table 1.1.

Repeat the titration as many times as you think necessary to obtain accurate results.

Make certain that the recorded results show the precision of your practical work.

Table 1.1 Titration of **FB 2** with **FB 1**

Final burette reading / cm^3				
Initial burette reading / cm^3				
Volume of FB 1 used / cm^3				

[8]

Summary

25.0 cm^3 of **FB 2** reacted with cm^3 of **FB 1**.

Show which results you used to obtain this volume of **FB 1** by placing a tick (✓) under the readings in Table 1.1.

You are advised to show full working in all parts of the calculations.

- (b) Calculate how many moles of potassium manganate(VII) were run from the burette into the conical flask during the titration of **FB 2** with **FB 1**.

[1]

- (c) Use the half equations for the reaction

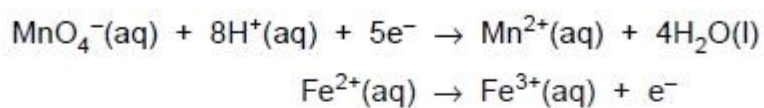

and your answer to (b) to calculate the concentration of Fe^{2+} , in mol dm^{-3} , in **FB 2**.

[2]

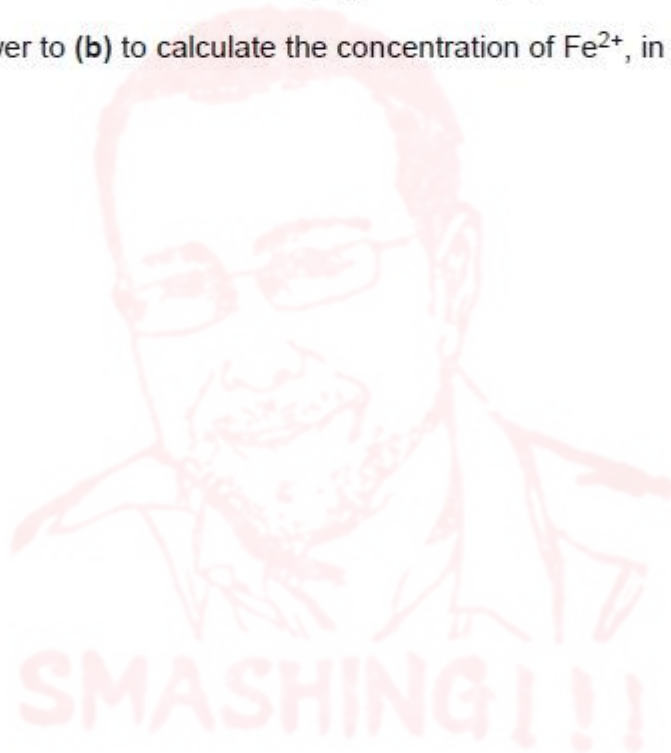

(d) *Experiment 2*

Fill the second burette with **FB 3**, the aqueous solution of **X**.

Pipette 25.0 cm³ of **FB 2** into a conical flask and add, using the measuring cylinder provided, 10 cm³ of 1 mol dm⁻³ sulphuric acid.

Add, from the second burette, 4.00 cm³ of FB 3. This oxidises some of the Fe²⁺ that has been pipetted into the flask.

Titrate the remaining Fe²⁺ in the conical flask with **FB 1**, potassium manganate(VII) until the first permanent pink colour remains.

Record the volume of **FB 3** added and your burette readings in Table 1.2.

One accurate titration will be sufficient. Remember that the volume added will be less than in *Experiment 1* as some of the Fe²⁺ has been oxidised by X.

Table 1.2 Titration of FB 2/FB 3 mixture with FB 1

Volume of FB 3 added	/ cm ³	0.00	4.00	8.00	12.00
Final burette reading	/ cm ³				
Initial burette reading	/ cm ³				
Volume of FB 1 added	/ cm ³				

↑
Enter the titration value from *Experiment 1*.

[3]

Empty and rinse the conical flask.

Repeat *Experiment 2*, using the volumes of **FB 3** shown in Table 1.2.

Record your results in Table 1.2.

(e) Plot the volume of **FB 1** against the volume of **FB 3**.

Your scale on the **FB 3** axis should extend to 30.00 cm³.

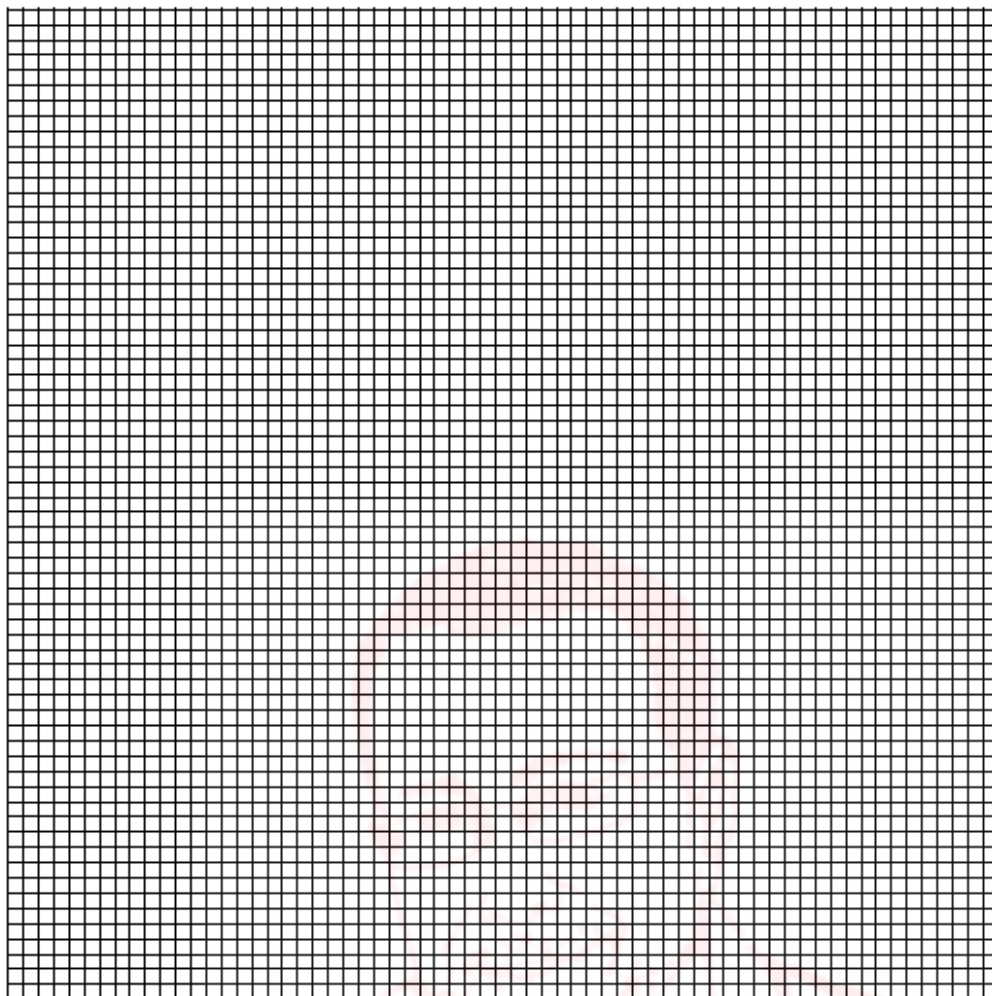

i	
ii	
iii	
iv	

[5]

(f) Draw the best-fit straight line through the plotted points.

[1]

(g) From your graph find the volume of **FB 3** that reacts with the Fe²⁺ present in 25.0 cm³ of **FB 2**.

[1]

[Total 21]

EXPERIMENT Required, no longer needed from 2007 onwards.

- 1 **FB 1** is an aqueous solution containing 100.00 g dm^{-3} of sodium thiosulphate, $\text{Na}_2\text{S}_2\text{O}_3 \cdot 5\text{H}_2\text{O}$.
FB 2 is an aqueous solution containing $0.023 \text{ mol dm}^{-3}$ of the chromate ion, CrO_4^{2-} .

Chromate ions, CrO_4^{2-} , oxidise iodide ions, I^- , in the presence of acid, H^+ , and produce aqueous iodine, I_2 which can be titrated with sodium thiosulphate.

You are to use this reaction to show that the CrO_4^{2-} ion is reduced to Cr^{3+} during this reaction.

- (a) Use a burette to measure between 45.0 cm^3 and 45.5 cm^3 of **FB 1** into the 250 cm^3 volumetric (graduated) flask labelled **FB 3**.
 Record your burette readings in Table 1.1.

Table 1.1 Dilution of FB 1

Final burette reading	/ cm^3	
Initial burette reading	/ cm^3	
Volume of FB 1	/ cm^3	

[2]

Fill the flask to the mark with distilled or deionised water and mix the contents thoroughly by shaking.

This solution is **FB 3**. Fill the second burette with the solution **FB 3** you have prepared.

- (b) Pipette 25.0 cm^3 of **FB 2** into a conical flask and add, from a measuring cylinder, 10 cm^3 of dilute sulphuric acid and 10 cm^3 of 5% aqueous potassium iodide, KI.
 Titrate the contents of the conical flask with **FB 3** until the colour of the iodine solution has faded to a light orange/yellow colour. Add 1 cm^3 of starch indicator and continue the titration until the blue-black colour of the starch-iodine complex disappears leaving the transparent pale blue colour of Cr^{3+} . Record your burette readings in Table 1.2.

Repeat the titration as many times as you think necessary to obtain accurate results.

Make certain that the recorded results show the precision of your practical work.

Table 1.2 Titration of FB 2 with FB 3

Final burette reading / cm^3				
Initial burette reading / cm^3				
Volume of FB 3 used / cm^3				

[10]

Summary

25.0 cm^3 of **FB 2** reacted with cm^3 of **FB 3**.

Show which results you used to obtain this volume of **FB 3** by placing a tick (✓) under the readings in Table 1.2.

- (c) Calculate the concentration in mol dm⁻³ of sodium thiosulphate, Na₂S₂O₃·5H₂O, in **FB 1**.
[Na, 23.0; S, 32.1; O, 16.0; H, 1.0.]

[1]

- (d) Calculate the concentration in mol dm⁻³ of sodium thiosulphate in the diluted solution **FB 3**.

[1]

- (e) Calculate the number of moles of sodium thiosulphate run into the flask during the titration and use this figure and the equations below to calculate the moles of iodine, I₂, present in the titration flask.

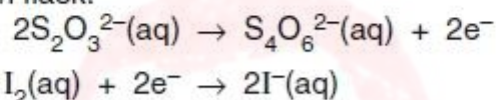

[2]

- (f) Calculate the number of moles of CrO₄²⁻ ion pipetted into the titration flask.

[1]

- (g) Calculate the number of moles of iodine, I₂, produced by 1 mole of CrO₄²⁻.

[1]

- (h) Use your answer to (g) and oxidation numbers to show that CrO₄²⁻ has been reduced to Cr³⁺.

[2]

[Total 20]



- 2** 'Lawn sand' is spread over the grass in gardens to reduce the growth of moss. Lawn sand is a mixture of sand and iron(II) sulfate crystals, $\text{FeSO}_4 \cdot 7\text{H}_2\text{O}$.

Lawn sand usually contains 6–10% $\text{FeSO}_4 \cdot 7\text{H}_2\text{O}$ by mass.

To determine the exact percentage by mass of $\text{FeSO}_4 \cdot 7\text{H}_2\text{O}$ present in a sample of lawn sand, a student devises the following experiment.

- step 1** Use a known mass of lawn sand to prepare 250.0 cm^3 of solution **A** containing $\text{Fe}^{2+}(\text{aq})$ ions. Solution **A** must have dilute sulfuric acid, $\text{H}_2\text{SO}_4(\text{aq})$, added to it **before** it is made up to 250 cm^3 .
- step 2** To determine the concentration of $\text{Fe}^{2+}(\text{aq})$ in solution **A**, titrate a 25.00 cm^3 sample of solution **A** against $0.0200 \text{ mol dm}^{-3}$ aqueous potassium manganate(VII), $\text{KMnO}_4(\text{aq})$.

The reaction which takes place during the titration is shown.

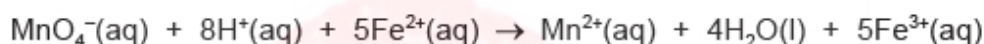

- (a) (i)** The end-point of the titration is 25.00 cm^3 of $0.0200 \text{ mol dm}^{-3}$ $\text{KMnO}_4(\text{aq})$.

Determine the concentration of $\text{Fe}^{2+}(\text{aq})$ that was present in the 25.00 cm^3 sample of solution **A** at the start of the titration.

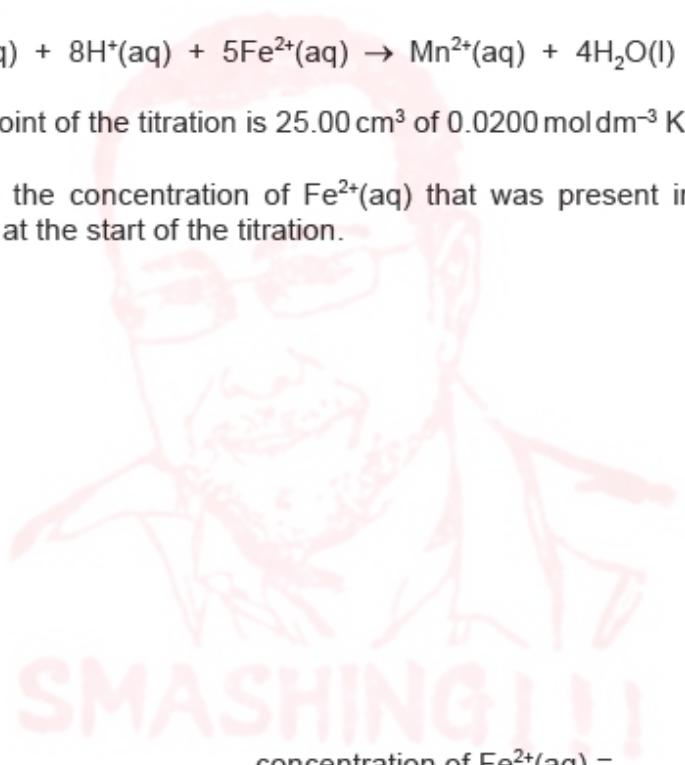

concentration of $\text{Fe}^{2+}(\text{aq}) = \dots\dots\dots \text{mol dm}^{-3}$ [1]

If you were unable to calculate the concentration in (i), assume for (ii) and (iii) that the concentration of $\text{Fe}^{2+}(\text{aq})$ is $0.300 \text{ mol dm}^{-3}$. This is **not** the correct answer.

- (ii) Determine the mass of lawn sand needed to prepare the 250.0 cm^3 of solution **A** at the concentration calculated in (i).

Assume that lawn sand contains 8% $\text{FeSO}_4 \cdot 7\text{H}_2\text{O}$ by mass.

[A_r: Fe, 55.8; S, 32.1; O, 16.0; H, 1.0]

mass of lawn sand = g [3]

- (iii) Solution **A** must contain enough $\text{H}^+(\text{aq})$ ions for the reaction to take place during the titration.

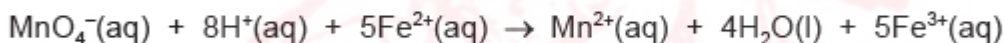

Use the concentration of $\text{Fe}^{2+}(\text{aq})$ from (i) to determine the minimum volume of 2.00 mol dm^{-3} $\text{H}_2\text{SO}_4(\text{aq})$ which must be added to prepare the 250.0 cm^3 of solution **A**.

volume = cm^3 [2]

- 1** Brass is an alloy of copper and zinc. Typical copper concentrations vary from 50% to 85%, depending upon the properties needed in the alloy. There may be small amounts of other metals present.

A student found a method to determine the percentage of copper in a sample of brass.

A known mass of brass powder is reacted with excess concentrated nitric acid. Both the copper and the zinc and any other metals present are oxidised into aqueous ions by the nitric acid. The amount of $\text{Cu}^{2+}(\text{aq})$ ions present can be determined by a titration technique.

step 1 Use a weighing boat to accurately weigh by difference approximately 2 g of brass powder and place the brass into a small glass beaker.

step 2 In a fume cupboard add **approximately** 20 cm³ of concentrated nitric acid to the brass in the beaker. Allow the brass to completely react to form solution **A**.

The equation for the reaction is shown.

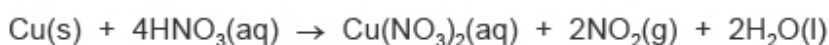

step 3 Dilute **all** of solution **A** to form exactly 250.0 cm³ of solution **B**.

step 4 Place 25.00 cm³ of solution **B** into a conical flask.

step 5 Use a dropping pipette to add aqueous sodium carbonate, $\text{Na}_2\text{CO}_3(\text{aq})$, to solution **B** in the conical flask until there is no more acid present.

step 6 Add approximately 20 cm³ of aqueous potassium iodide, $\text{KI}(\text{aq})$, to the conical flask. A white precipitate forms as well as a brown solution of aqueous iodine, $\text{I}_2(\text{aq})$.

step 7 Fill a burette with 0.100 mol dm⁻³ sodium thiosulfate solution, $\text{Na}_2\text{S}_2\text{O}_3(\text{aq})$, so it is ready for the titration in **step 8**.

step 8 Carry out a titration of the aqueous iodine produced in the conical flask against the 0.100 mol dm⁻³ $\text{Na}_2\text{S}_2\text{O}_3(\text{aq})$.



- (a) Outline how the student should accurately weigh by difference in **step 1** in order that the exact mass of brass transferred into the small glass beaker is known. Include a results table, with appropriate headings, ready for the student to fill in.

.....
.....

[2]

- (b) Suggest why it is necessary to do **step 2** in a fume cupboard.

..... [1]

- (c) Outline how the student should carry out **step 3**. Include the name and capacity of the suitable piece of apparatus in which solution **B** should be prepared.

.....
.....
.....
..... [2]

- (d) Name the apparatus needed to transfer solution **B** into the conical flask in **step 4**.

..... [1]

- (e) State how the student would know there was no more acid present in the mixture in **step 5**.

..... [1]

- (f) The student is given 200 cm^3 of $0.100\text{ mol dm}^{-3}\text{ Na}_2\text{S}_2\text{O}_3(\text{aq})$.

Outline how the student should use this solution to fill the burette in **step 7** so it is ready for titration. Include any relevant procedures the student should follow to ensure the burette is correctly filled before any readings are taken.

.....
.....
.....
..... [2]

(g) The titration table the student used is shown.

- (i) Complete the table and calculate the mean titre to be used in calculating the percentage of copper in brass.
Show your working.

titration number	rough	1	2	3	
final burette reading / cm ³	20.50	40.25	19.90	39.65	
initial burette reading / cm ³	0.00	20.60	0.00	19.90	
titre / cm ³					

mean titre = cm³ [2]

- (ii) The burette used by the student has graduations of 0.10 cm³.

Determine the percentage error in the titre measured in titration number 2.

Show your working.

percentage error = [1]

- (iii) Other than a change in apparatus, suggest one change to the experiment which would lead to a reduction in the percentage error in a measured titre.

.....
..... [1]



(h) **Steps 1–8** were repeated, this time using 1.88 g of brass. The end-point of the titration was found to be 16.50 cm³.

The equations for the reactions occurring are shown.

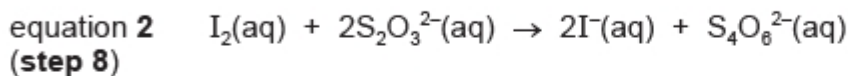
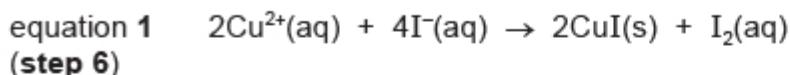

(i) Determine the number of moles of I₂ formed when excess KI(aq) was added to 25.00 cm³ of solution **B** in **step 6**.

Use the data from the repeated experiment in your calculations.

moles of I₂ = [2]

(ii) Use your answer to (h)(i) to determine the mass of Cu²⁺ ions in solution **A** and therefore the percentage by mass of copper in this sample of brass.

If you were unable to obtain an answer to (h)(i), assume the number of moles of I₂ to be 8.85 × 10⁻⁴ mol. This is **not** the correct value.

[A_r: Cu, 63.5]

percentage by mass of copper in the sample of brass = [3]

(i) A small percentage of silver is sometimes found in some brass alloys.

In **step 2**, when concentrated nitric acid is added, silver metal is oxidised to silver ions, Ag⁺(aq).

At the end of **step 6** the Ag⁺(aq) ions no longer remain in solution.

Explain why.

..... [1]

[Total: 19]



1 Aqueous potassium manganate(VII) can be used to determine the amount of iron present in a sample of iron wire by redox titration. Before potassium manganate(VII) can be used, its concentration must be determined using aqueous sodium ethanedioate made from the hydrated solid $\text{Na}_2\text{C}_2\text{O}_4 \cdot 2\text{H}_2\text{O}$.

- (a) (i)** Calculate the mass of $\text{Na}_2\text{C}_2\text{O}_4 \cdot 2\text{H}_2\text{O}$ required to make 250.0 cm^3 of 0.200 mol dm^{-3} sodium ethanedioate standard solution.
[A_r: Na, 23.0; C, 12.0; O, 16.0; H, 1.0]

mass of $\text{Na}_2\text{C}_2\text{O}_4 \cdot 2\text{H}_2\text{O}$ = g [1]

- (ii)** Describe how the student should accurately prepare 250.0 cm^3 of 0.200 mol dm^{-3} sodium ethanedioate standard solution from the weighed sample of $\text{Na}_2\text{C}_2\text{O}_4 \cdot 2\text{H}_2\text{O}$ of mass calculated in **(a)(i)**.
In your description you should include the names and capacities of any apparatus used.

.....
.....
.....
..... [2]

- (b)** Ethanedioate ions, $\text{C}_2\text{O}_4^{2-}(\text{aq})$, react with manganate(VII) ions, $\text{MnO}_4^{-}(\text{aq})$, according to the ionic equation shown.

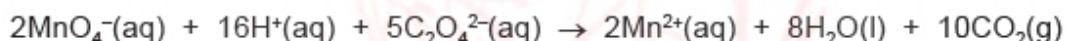

25.0 cm^3 of 0.200 mol dm^{-3} $\text{C}_2\text{O}_4^{2-}(\text{aq})$ required 18.40 cm^3 $\text{MnO}_4^{-}(\text{aq})$ for complete reaction.

Calculate the concentration of the aqueous potassium manganate(VII). Give your answer to **three significant figures**.

concentration of aqueous potassium manganate(VII) = mol dm^{-3} [3]



(c) In another experiment, a student uses $0.0200 \text{ mol dm}^{-3} \text{ MnO}_4^- (\text{aq})$ to analyse the percentage of iron in a sample of iron wire using the following method.

step 1 The mass of the iron wire is recorded.

step 2 The iron wire is dissolved in 20 cm^3 , an excess, of sulfuric acid and made up to a volume of 250.0 cm^3 with distilled water. The iron reacts and dissolves in sulfuric acid to form $\text{Fe}^{2+} (\text{aq})$ ions.

step 3 A 25.0 cm^3 sample of this Fe^{2+} containing solution is titrated with $0.0200 \text{ mol dm}^{-3} \text{ MnO}_4^- (\text{aq})$.

The ionic equation for the reaction between $\text{MnO}_4^- (\text{aq})$ and $\text{Fe}^{2+} (\text{aq})$ is shown.

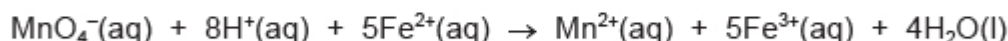

The student's results are shown in the table.

[A_r : Fe, 55.8]

	rough	titration 1	titration 2	titration 3	titration 4
final burette reading / cm^3	45.50	44.75	44.45	44.80	44.40
initial burette reading / cm^3	0.00	0.10	0.15	0.00	0.00
titre / cm^3	45.50	44.65	44.30	44.80	44.40

(i) Circle the titres the student should use to obtain the most accurate value for the volume of $0.0200 \text{ mol dm}^{-3} \text{ KMnO}_4$ that is needed to react with 25.0 cm^3 of the prepared iron solution. Explain your answer.

.....
..... [1]

(ii) The burette used for the titration has graduations every 0.10 cm^3 .

Calculate the maximum percentage error in the titre of titration 2.

Show your working.

percentage error = [1]



- (iii) Derive an expression to show how you would calculate the percentage by mass of iron in the iron wire.
Use x to represent the average titre and y to represent the mass of iron wire used.

expression for mass of iron in the iron wire = [2]

- (iv) The student left the solution of $\text{Fe}^{2+}(\text{aq})$ in sulfuric acid without a stopper for a few days. The student repeated the titration and found that the average titre was lower.

Suggest why.

.....
..... [1]

- (v) In **step 2**, the sulfuric acid is used to dissolve the iron in the iron wire.

Suggest the other function of the sulfuric acid in this experiment.

.....
..... [1]

- (d) Name an appropriate piece of apparatus to measure the volume of sulfuric acid in **step 2**. Give a reason for your answer.

.....
..... [1]

[Total: 13]

(b) Determining the number of moles of $C_2O_4^{2-}$ present

Ethanedioate ions, $C_2O_4^{2-}(aq)$, react with manganate(VII) ions, $MnO_4^-(aq)$, in acidified conditions, as shown.

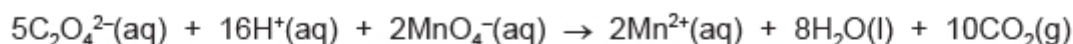

$MnO_4^-(aq)$ ions are a very deep purple in colour. All other species appear colourless.

The reaction takes place above a temperature of $70^\circ C$.

The student carries out a redox titration using the following steps.

step 1 The student rinses and fills a burette with $0.0200 \text{ mol dm}^{-3} MnO_4^-(aq)$.

step 2 The student uses a pipette to transfer 25.0 cm^3 of solution **A** into a conical flask.

step 3 The student adds 20 cm^3 , an excess, of $0.5 \text{ mol dm}^{-3} H_2SO_4(aq)$ to the conical flask.

step 4 The conical flask is heated until a temperature of about $80^\circ C$ is reached.

step 5 The student adds $MnO_4^-(aq)$ from the burette until an end-point is reached.

The student repeats the titration until concordant readings are achieved.

	rough	titration 1	titration 2	titration 3
final burette reading / cm^3	25.05	24.50	26.60	24.50
initial burette reading / cm^3	0.10	0.10	0.10	0.10
titre / cm^3	25.05	24.40	26.50	24.40

The student determines the average titre to be 24.40 cm^3 .

(i) When emptying the pipette in **step 2**, the student touches the surface of the solution in the flask with the tip of the pipette.

Suggest why the student does this.

.....
..... [1]

(ii) Suggest the most appropriate piece of apparatus to measure $H_2SO_4(aq)$ in **step 3**.

..... [1]

(iii) Suggest why the student starts each titration with an initial burette reading of 0.10 cm^3 rather than the usual 0.00 cm^3 .

..... [1]

(iv) What is meant by the term *concordant readings*?

..... [1]

(v) State the change of colour seen in the mixture in the conical flask at the end-point.

from to [1]

(vi) Determine the number of moles of $\text{C}_2\text{O}_4^{2-}$ ions in the 250.0 cm^3 of solution **A**, $\text{K}_a\text{H}_b(\text{C}_2\text{O}_4)_c \cdot d\text{H}_2\text{O}$.

Give your answer to **three** significant figures.

moles of $\text{C}_2\text{O}_4^{2-}$ ions in 250.0 cm^3 of solution **A** = mol [3]

If you were unable to calculate an answer to (b)(vi), then you may use the value $1.18 \times 10^{-2}\text{ mol}$ for your calculations in (c). This is **not** the correct value.

(c) The student then does an acid–base titration of solution **A** to determine the values of *a* and *b* in $\text{K}_a\text{H}_b(\text{C}_2\text{O}_4)_c \cdot d\text{H}_2\text{O}$.

(i) Suggest the name of a suitable reagent to use in this titration.

..... [1]

(ii) The student finds the concentration of $\text{H}^+(\text{aq})$ in solution **A** is $6.10 \times 10^{-2}\text{ mol dm}^{-3}$.

Use this value and your answer to (b)(vi) to determine the ratio of *c* to *b* to **two** decimal places.

Then deduce the value of *a* in $\text{K}_a\text{H}_b(\text{C}_2\text{O}_4)_c \cdot d\text{H}_2\text{O}$ to **two** decimal places.

ratio *c*:*b* = 1:.....

value of *a* =

[3]

- (iii) Use your answer to (b)(vi), (c)(ii) and other information given in the question to determine the mass of 1 mol of $K_aH_b(C_2O_4)_c \cdot dH_2O$ and hence determine the value of d to the nearest whole number.

[A_r : K, 39.1; H, 1.0; C, 12.0; O, 16.0]

If you were unable to calculate an answer to (c)(ii), then you may use $a = 0.30$ and ratio $c:b = 1:1.60$. These are **not** the correct values.

mass of 1 mol of $K_aH_b(C_2O_4)_c \cdot dH_2O = \dots\dots\dots$ g

value of $d = \dots\dots\dots$

[2]

- (d) A second student uses another method to determine d . Crystals of the sample, with known values of a , b and c , are heated in a crucible to remove the water molecules.

Construct a results table to show the readings that would need to be taken during this experiment.

[2]

[Total: 20]

2 A student is given 250.0 cm³ of solution containing a mixture of Fe²⁺ and Fe³⁺ ions. The student is asked to find the total mass of iron ions and the percentage by mass of Fe³⁺ in the solution by performing titrations with aqueous potassium manganate(VII), KMnO₄.

The student is told that the Fe³⁺(aq) ions can be reduced to Fe²⁺(aq) ions by reaction with zinc.

The student is given the following instructions.

- Calculate the mass of KMnO₄ needed to make 500.0 cm³ of 0.0200 mol dm⁻³ KMnO₄(aq).
- Record the mass of an empty plastic weighing boat (a small container used to hold solid samples).
- Add the calculated mass of KMnO₄ to the weighing boat.
- Transfer the KMnO₄ from the weighing boat into a 100 cm³ beaker.
- Add 50 cm³ of distilled water to the beaker.
- Transfer the mixture from the beaker into a 500.0 cm³ volumetric flask.
- Make up to the graduation mark, dropwise, with distilled water.

(a) (i) Calculate the mass of KMnO₄ needed to make 500.0 cm³ of 0.0200 mol dm⁻³ KMnO₄(aq).

[A_r: K, 39.1; Mn, 54.9; O, 16.0]

mass of KMnO₄ needed = g [1]

(ii) The student used a balance accurate to two decimal places.

Calculate the percentage error in weighing the mass of the KMnO₄ by difference.

If you were unable to calculate a value for **2(a)(i)** use the mass 1.75g. This is **not** the correct answer to **2(a)(i)**. Show your working.

percentage error = % [1]

(iii) The student noticed that some crystals of KMnO₄ were stuck to the weighing boat after adding the KMnO₄ solid to the beaker.

State how the student should modify the instructions to ensure that the measured mass of KMnO₄ was accurate.

.....
.....
..... [1]



(iv) Give two additional instructions that should be given to the student to ensure that the solution is prepared as accurately as possible.

1

.....

2

.....

[2]

(b) When the $\text{KMnO}_4(\text{aq})$ is ready for use, the student is given additional instructions.

step 1 Fill a burette with $0.0200 \text{ mol dm}^{-3} \text{ KMnO}_4(\text{aq})$.

step 2 Using a measuring cylinder, transfer 25.00 cm^3 of $\text{Fe}^{2+}(\text{aq})/\text{Fe}^{3+}(\text{aq})$ solution into a conical flask.

step 3 Add 10 cm^3 of 1.0 mol dm^{-3} sulfuric acid to the conical flask.

step 4 Titrate this acidified solution of $\text{Fe}^{2+}(\text{aq})/\text{Fe}^{3+}(\text{aq})$ with $0.0200 \text{ mol dm}^{-3} \text{ KMnO}_4(\text{aq})$ until the end-point.

step 5 Repeat titrations until the titres are concordant.
This set of results is **set A**.

step 6 Using a measuring cylinder, add 100 cm^3 of the $\text{Fe}^{2+}(\text{aq})/\text{Fe}^{3+}(\text{aq})$ solution into a beaker then add excess zinc. Allow time for reduction to $\text{Fe}^{2+}(\text{aq})$ to take place.

step 7 Filter the mixture into a beaker.

step 8 Transfer 25.00 cm^3 of the filtrate into a conical flask and add 10 cm^3 of 1.0 mol dm^{-3} sulfuric acid.

step 9 Titrate this acidified solution of the filtrate with $0.0200 \text{ mol dm}^{-3} \text{ KMnO}_4(\text{aq})$ until the end-point.

step 10 Repeat **steps 8** and **9** twice.
This set of results is **set B**.

(i) How should the burette be prepared for use before it is filled in **step 1**?

.....

..... [1]

(ii) What must be done to ensure as accurate an end-point as possible?

.....

..... [1]



(c) (i) Identify an experimental weakness in **step 2**. Explain how this would affect the results.

.....
.....
..... [1]

(ii) How could this weakness be overcome?

..... [1]

(d) The results for each set of titrations are shown.

set A

	rough	titration 1	titration 2	titration 3
final volume / cm ³	18.40	17.25	34.55	18.00
initial volume / cm ³	0.65	0.15	17.25	0.95
titre / cm ³				

set B

	rough	titration 1	titration 2	titration 3
final volume / cm ³	45.05	43.60	43.70	
initial volume / cm ³	0.20	0.15	0.10	
titre / cm ³				

(i) Complete both tables and calculate an appropriate average titre for each set of results. The student could **not** carry out titration 3 in **set B**.

Record the average titre to **one decimal place**.

set A average titre = cm³

set B average titre = cm³
[2]



(ii) The reaction taking place during the titrations is shown by the equation.

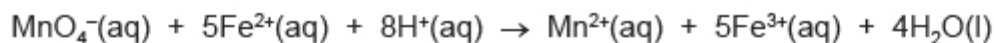

Calculate the mass of Fe^{2+} ions in 100 cm^3 of the reduced solution, produced in **step 6**, by using the appropriate average titre from **(d)(i)**.

Give your answer to **three significant figures**.

[A_r : Fe, 55.8]

mass of Fe^{2+} ions = g [2]

(iii) Calculate the mass of Fe^{2+} ions in the original 250.0 cm^3 $\text{Fe}^{2+}(\text{aq})/\text{Fe}^{3+}(\text{aq})$ solution, using the appropriate average titre from **2(d)(i)**.

mass of Fe^{2+} ions = g [1]

(iv) Calculate the percentage by mass of Fe^{3+} ions in the original 250.0 cm^3 $\text{Fe}^{2+}(\text{aq})/\text{Fe}^{3+}(\text{aq})$ solution.

percentage by mass of Fe^{3+} ions = % [1]

(v) State what change could be made to the procedure to enable titration 3 to be carried out in **set B**.

.....
..... [1]

[Total: 16]



- 2 The acid dissociation constant, K_a , of a weak monoprotic acid, HA, is to be determined from the measurement of the pH change that occurs when it is titrated with an aqueous solution of sodium hydroxide.

2.70 g of HA was dissolved in distilled water to make exactly 250.0 cm³ of solution.

25.00 cm³ of the solution was pipetted into a beaker.

The pH of the acid in the beaker was measured and recorded in the table below.

A burette was then filled with aqueous sodium hydroxide and the 25.00 cm³ of HA was titrated by adding volumes of the aqueous sodium hydroxide to the beaker as indicated in the table below. After each addition the pH was measured and the value recorded.

volume of sodium hydroxide added / cm ³	pH measured
0.00	2.41
2.00	2.75
4.00	3.09
8.00	3.46
12.00	3.52
16.00	3.96
20.00	4.20
24.00	4.50
28.00	5.05
30.00	7.00
32.00	11.55
36.00	12.00

(a) Plot a graph to show how the pH of the mixture changes with the volume of added aqueous sodium hydroxide as shown in the table.

Draw a smooth curve, using the plotted points on your graph, to produce a titration curve for the addition of aqueous sodium hydroxide to the acid HA.



(b) Circle any points on the graph that are anomalous and suggest a reason why this might occur.

.....
.....
.....
..... [2]

(c) What would be a suitable range of pH values in which an indicator would change colour to identify the end point of this neutralisation?

.....
..... [1]

(d) 30.00 cm³ of aqueous sodium hydroxide is required to neutralise 25.00 cm³ of HA and the equation for the neutralisation is shown.

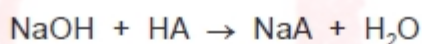

(i) Excluding water, state the three ions or molecules that will be present in the highest concentration when 15.00 cm³ of aqueous sodium hydroxide has been added to 25.00 cm³ of HA.

.....
..... [1]

(ii) State and explain how the concentrations of these ions or molecules compare.

.....
.....
.....
..... [2]



- (e) Use your graph to determine the pH obtained when 15.00 cm^3 of aqueous sodium hydroxide is added to 25.00 cm^3 of HA. Use this pH to determine the value of K_a for HA.

[3]

- (f) (i) Use your answer to (e) and the initial pH of HA from the table to calculate the concentration of HA in mol dm^{-3} .

[2]

- (ii) Calculate the initial concentration of HA, in g dm^{-3} , and use this together with your answer to (f)(i) to calculate the relative molecular mass, M_r , of HA. (Remember that 2.70 g of HA was dissolved in distilled water to make exactly 250.0 cm^3 of solution.)

[1]

- (g) Even if the experiment is done very carefully with very accurate apparatus, the answer obtained for the molecular mass of HA is likely to be subject to error. Suggest why.

.....

.....

.....

..... [1]

[Total: 15]



- 1 A saturated aqueous solution of magnesium methanoate, $\text{Mg}(\text{HCOO})_2$, has a solubility of approximately 150 g dm^{-3} at room temperature. Its exact solubility can be determined by titrating magnesium methanoate against aqueous potassium manganate(VII).

During the titration, the methanoate ion, HCOO^- , is oxidised to carbon dioxide while the manganate(VII) ion, MnO_4^- , is reduced to Mn^{2+} .

You are supplied with:

a saturated aqueous solution of $\text{Mg}(\text{HCOO})_2$

aqueous potassium manganate(VII), KMnO_4 , of concentration $0.0200 \text{ mol dm}^{-3}$

- (a) (i) Write the half equations for the oxidation of $\text{HCOO}^-(\text{aq})$ to $\text{CO}_2(\text{g})$ and the reduction of $\text{MnO}_4^-(\text{aq})$ to $\text{Mn}^{2+}(\text{aq})$ in acid solution.

.....
..... [2]

- (ii) Using the approximate solubility above, calculate the concentration, in mol dm^{-3} , of the saturated aqueous magnesium methanoate and the concentration of the methanoate ions present in this solution.

[A_r : H, 1.0; C, 12.0; O, 16.0; Mg, 24.3]

[2]

- (iii) In order to obtain a reliable titre value, the saturated solution of magnesium methanoate needs to be diluted.

Describe how you would accurately measure a 5.0 cm^3 sample of saturated magnesium methanoate solution and use it to prepare a solution fifty times more dilute than the saturated solution.

.....
.....
.....
..... [2]

- (iv) Before the titration is carried out, dilute sulfuric acid must be added to the magnesium methanoate.

Explain why this is necessary and also whether the volume of sulfuric acid chosen will affect the result of the titration.

.....
.....
.....
..... [2]

- (v) The potassium manganate(VII) is added from a burette into the magnesium methanoate in a conical flask.

Describe what you would see when you had reached the end-point of the titration.

.....
..... [1]

- (vi) 1 mol of acidified MnO_4^- ions reacts with 2.5 mol of HCOO^- ions.

25.0 cm³ of the diluted solution prepared in (iii) required 25.50 cm³ of 0.0200 mol dm⁻³ potassium manganate(VII) solution to reach the end-point.

Use this information to calculate the concentration, in mol dm⁻³, of HCOO^- ions in the diluted solution.

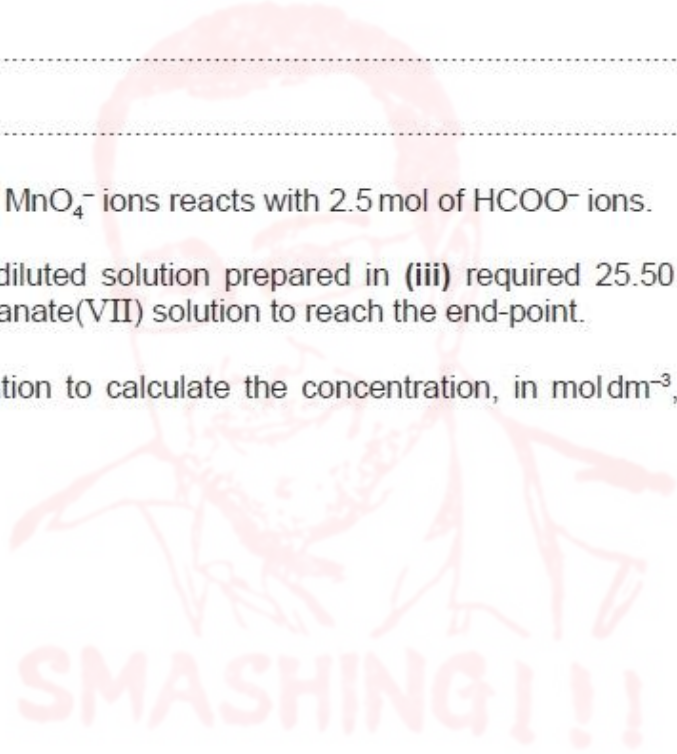

..... mol dm⁻³ [1]

- (vii) Use your answer to (vi) to calculate the concentration, in mol dm⁻³, of the saturated solution of magnesium methanoate, $\text{Mg}(\text{HCOO})_2$. Give your answer to **three significant figures**.

..... mol dm⁻³ [1]

- (b) The solubility of magnesium methanoate can be determined at higher temperatures using the same titration.

In an experiment to determine how the concentration of saturated magnesium methanoate varies with temperature, name the independent variable and the dependent variable.

independent variable

dependent variable

[1]

- (c) The solubility of magnesium methanoate increases with temperature.

What does this tell you about ΔH for the process below?

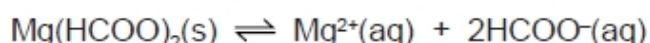

Explain your answer.

.....
.....
.....
..... [2]

- (d) A student used the same titration method, this time to measure the concentration of a saturated solution of *barium* methanoate.

Explain why the acidification of the solution with dilute sulfuric acid might make the titration difficult to do.

.....
..... [1]

[Total: 15]

- 1 When hydrated barium chloride, $\text{BaCl}_2 \cdot x\text{H}_2\text{O}$, dissolves in water, $\text{Ba}^{2+}(\text{aq})$ and $\text{Cl}^{-}(\text{aq})$ ions are formed.

The concentration of chloride ions in solution can be determined by titration with aqueous silver nitrate of known concentration.

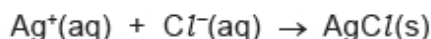

The indicator for the reaction is aqueous potassium chromate(VI), $\text{K}_2\text{CrO}_4(\text{aq})$. At the endpoint of the titration, it forms a red precipitate in the presence of excess silver ions.

- (a) The solubilities, in g dm^{-3} , of different ionic compounds at 20°C are given in the table below.

cation	anion		
	Cl^{-}	CrO_4^{2-}	SO_4^{2-}
Ag^{+}	0.0019	0.022	293
Ba^{2+}	358	0.0028	0.00245

With reference to these data, where relevant, answer the following questions.

- (i) Name the red precipitate and give an equation for its formation.

name:

equation:

[2]

Sulfuric acid must be added to the solution to prevent the $\text{Ba}^{2+}(\text{aq})$ ions from interfering with the action of the potassium chromate(VI) indicator.

- (ii) How would $\text{Ba}^{2+}(\text{aq})$ ions interfere with the action of this indicator?

.....

..... [1]

- (iii) How does the addition of sulfuric acid prevent $\text{Ba}^{2+}(\text{aq})$ ions from interfering with the action of this indicator?

.....

..... [1]



- (b) In an initial rough titration, excess silver nitrate solution is added so that the endpoint is exceeded.

Draw a sketch graph to show how the mass of silver chloride varies with the volume of silver nitrate added.

Label both axes.



[2]



- (v) In another experiment, a student dissolved 3.13g of hydrated barium chloride, $\text{BaCl}_2 \cdot x\text{H}_2\text{O}$, in distilled water to give 1.00 dm^3 of solution.

It was calculated that the concentration of $\text{Ba}^{2+}(\text{aq})$ ions was $0.0128 \text{ mol dm}^{-3}$.

Determine the value of x in $\text{BaCl}_2 \cdot x\text{H}_2\text{O}$.

[A_r : Ba, 137.3; Cl, 35.5; H, 1.0; O, 16.0]

$x = \dots\dots\dots$
[2]

- (d) The following information gives some of the hazards associated with the chemicals used in the procedure.

Barium chloride	Solid barium chloride is classified as toxic . Solutions equal to or more concentrated than 0.4 mol dm^{-3} are classified as moderate hazard and are harmful if swallowed. Solutions less concentrated than 0.4 mol dm^{-3} are classified as non-hazardous.
Potassium chromate(VI)	All solutions more concentrated than 0.9 mol dm^{-3} are classified as health hazard . They may cause skin, eye and respiratory irritation.
Silver nitrate	Solutions equal to or more concentrated than 0.18 mol dm^{-3} are classified as corrosive . Solutions equal to or more concentrated than 0.06 mol dm^{-3} but less than 0.18 mol dm^{-3} are classified as moderate hazard and cause skin and eye irritation. Solutions less concentrated than 0.06 mol dm^{-3} are classified as non-hazardous.

Identify **one** hazard that must be considered when planning the experiment and describe a precaution, other than eye protection, that should be taken to keep risks from this hazard to a minimum.

hazard:

precaution:

.....
[1]

[Total: 15]

1 Chlorine gas, Cl_2 , is slightly soluble in water, approximately 5 g dm^{-3} at 25°C . The molar enthalpy of solution of a gas is defined as the enthalpy change when one mole of the gas is dissolved in water.

- (a) (i) Predict how the solubility of chlorine in water changes as the temperature is increased. Explain this prediction using Le Chatelier's Principle in terms of the equilibrium between the gaseous chlorine and the aqueous solution, as shown in the equation.



Predict how the solubility will change as the temperature is increased.

.....

.....

Explanation

.....

.....

.....

- (ii) Display your prediction in the form of a sketch graph between 0°C and 100°C . Label the axes with units and give numerical values on the axes to ensure that the line clearly shows the solubility at 25°C and 100°C .



[4]

- (b) If you were to carry out an experiment to investigate how the **solubility** of chlorine varies as the **temperature increases** name,

(i) the independent variable,

.....

(ii) the dependent variable.

[1]



- (c) You are to plan an experiment to determine as accurately as possible the concentration of a saturated aqueous solution of chlorine by titration. You are reminded that the approximate solubility of chlorine is 5 g dm^{-3} at 25°C .

The following information gives some of the hazards associated with chlorine, iodine and sodium thiosulfate.

Saturated **chlorine water** is **low hazard** but chlorine gas escapes, which is **harmful**.

Iodine is **harmful** by inhalation and in contact with skin or eyes. Solutions more concentrated than or equal to 1 mol dm^{-3} are **harmful**.

Sodium thiosulfate is **non-hazardous**.

Aqueous chlorine, Cl_2 , displaces iodine, I_2 , from aqueous potassium iodide.



Therefore if a solution of chlorine is mixed with an excess of aqueous potassium iodide, iodine is displaced in a 1 : 1 molar ratio with chlorine.

The concentration of chlorine in the original solution can therefore be calculated from the concentration of the displaced iodine.

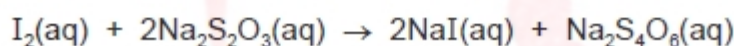

You are provided with the following materials:

saturated aqueous chlorine,
solid sodium thiosulfate $\text{Na}_2\text{S}_2\text{O}_3 \cdot 5\text{H}_2\text{O}$,
concentrated aqueous potassium iodide. This will be used in excess.

Give a step-by-step description of how you would carry out the experiment by including:

- (i) a list of apparatus with volumes where appropriate,
- (ii) a suitable indicator with relevant colours,
- (iii) a calculation of the approximate concentration of saturated aqueous chlorine in mol dm^{-3} at 25°C ,
[A_r : Cl, 35.5]
- (iv) a detailed description of the method for preparing a solution of aqueous sodium thiosulfate that can be used in the titration. In a titration, it is usual for the two reacting volumes to be approximately equal at the end-point. Calculate the mass of sodium thiosulfate, $\text{Na}_2\text{S}_2\text{O}_3 \cdot 5\text{H}_2\text{O}$, which will produce a solution suitable for use in this titration. The relevant calculations and reasoning must be shown in full,
[A_r : H, 1.0; O, 16.0; Na, 23.0; S, 32.1]
- (v) a detailed method for carrying out sufficient titrations to allow an accurate end-point to be obtained,
- (vi) an outline calculation to show how the results are to be used to determine the accurate concentration of the aqueous chlorine.

Handwriting practice lines consisting of 20 horizontal dashed lines.

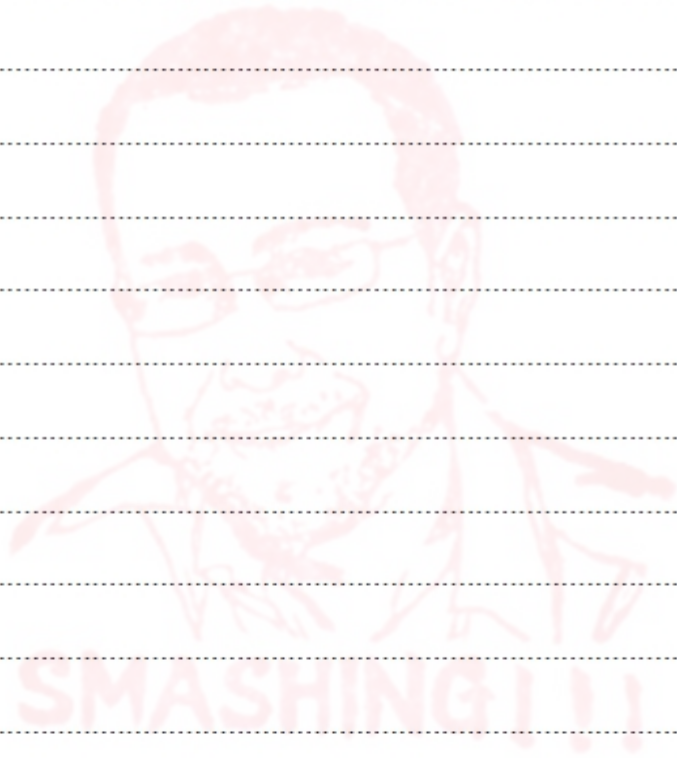

1 Yttrium barium copper oxide, $\text{YBa}_2\text{Cu}_3\text{O}_7$, is a crystalline compound.

You are to design an experiment in which $\text{YBa}_2\text{Cu}_3\text{O}_7$ is first synthesised and then analysed by titration.

(a) $\text{YBa}_2\text{Cu}_3\text{O}_7$ can be synthesised by reacting Y_2O_3 , BaCO_3 and CuO using the following method.

- Place solid Y_2O_3 , BaCO_3 and CuO together in a mortar and grind the mixture well with a pestle.
- Transfer the mixture to a porcelain crucible and place this in an oven set at 920°C .
- Heat the mixture for 12 hours, then allow the crucible and its contents to cool slowly in the oven to below 100°C before removing it.

The equation for the reaction is given.

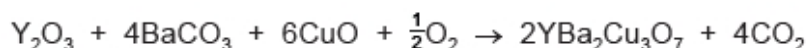

(i) $\text{YBa}_2\text{Cu}_3\text{O}_7$ contains Y, Ba and Cu in the molar ratio of 1:2:3.

Calculate the minimum masses of BaCO_3 and CuO that are needed to react with 0.750 g of Y_2O_3 , to give a Y:Ba:Cu ratio of 1:2:3.

[A_r : Y, 88.9; Ba, 137.3; Cu, 63.5; O, 16.0; C, 12.0]

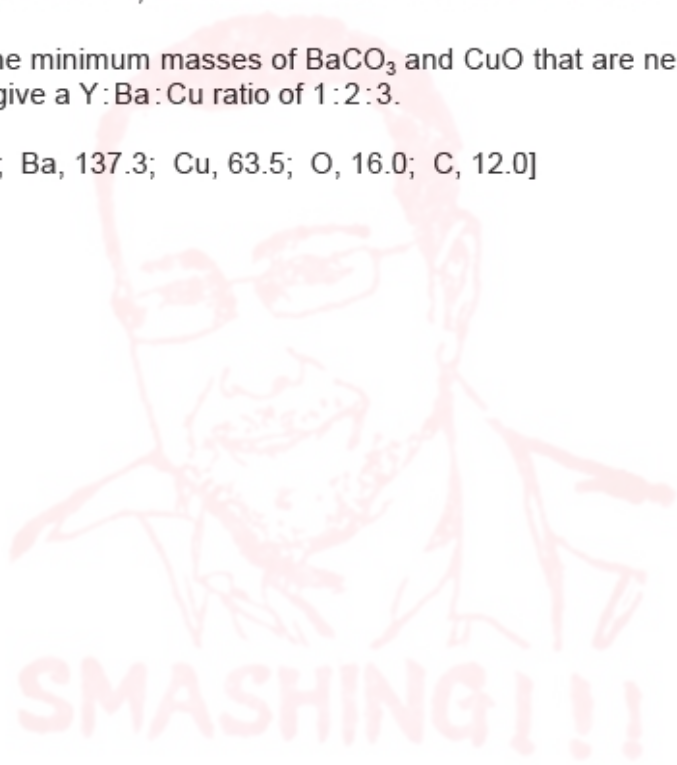

mass of BaCO_3 = g

mass of CuO = g
[3]

(ii) State what should be done once the solid product has cooled to ensure that the highest possible yield of $\text{YBa}_2\text{Cu}_3\text{O}_7$ has been produced.

.....

.....

.....

.....

[1]



YBa₂Cu₃O₇ contains some copper ions in the unusual +3 oxidation state.

The proportion of Cu³⁺ in YBa₂Cu₃O₇ can be determined by titration.

• **Step 1**

A sample of YBa₂Cu₃O₇ is reacted with an excess of concentrated aqueous HBr. Cu³⁺ ions are reduced to Cu²⁺ ions and Br₃⁻ ions are formed.

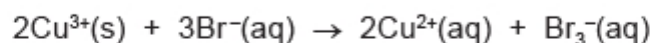

• **Step 2**

A solution of 1.0 mol dm⁻³ sodium citrate is added to the mixture from **Step 1**. The resulting mixture is then neutralised with a minimum volume of concentrated NH₃(aq).

• **Step 3**

Excess I⁻ is added which reacts with Br₃⁻ to form I₂.

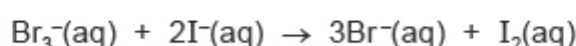

• **Step 4**

The I₂ is titrated with a standard solution of S₂O₃²⁻ and starch solution as an indicator.

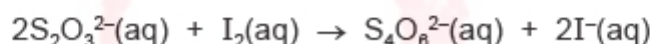

The concentration of I₂(aq) can therefore be determined and hence the concentration of Br₃⁻(aq). From this the amount of Cu³⁺(s) can be determined.

(b) The table gives some electrochemical data.

reduction process	E°/V
$\text{I}_2 + 2\text{e}^{-} \rightleftharpoons 2\text{I}^{-}$	+0.54
$\text{Cu}^{2+} + \text{I}^{-} + \text{e}^{-} \rightleftharpoons \text{CuI}$	+0.86
$\text{O}_2 + 4\text{H}^{+} + 4\text{e}^{-} \rightleftharpoons 2\text{H}_2\text{O}$	+1.23

Use these data and the information given above to answer the following questions.

(i) The citrate anion forms an insoluble complex with Cu²⁺ and so removes Cu²⁺ from solution.

Explain why this is necessary.

.....
.....
..... [1]

(ii) Explain why it is necessary to neutralise the mixture in **Step 2**.

.....
..... [1]

- (iii) When starch indicator is added in **Step 4**, the mixture turns blue-black due to the presence of $I_2(aq)$. The end-point of the titration with $S_2O_3^{2-}(aq)$ is a colourless solution.

The number of moles of $S_2O_3^{2-}(aq)$ needed for complete reaction with $I_2(aq)$ can be calculated from the mean titre value. Hence the moles of $I_2(aq)$ can be determined.

State the expression for the moles of Cu^{3+} in the sample of $YBa_2Cu_3O_7$. Use A to represent the number of moles of $I_2(aq)$ in **Step 4**.

moles Cu^{3+} = mol [1]

- (c) (i) Calculate the mass of hydrated sodium citrate, $Na_3C_6H_5O_7 \cdot 2H_2O$, that would be required for the preparation of 250.0 cm^3 of a solution of 1.0 mol dm^{-3} citrate ions, $C_6H_5O_7^{3-}$.

[M_r : $Na_3C_6H_5O_7 \cdot 2H_2O$, 294.0]

mass of $Na_3C_6H_5O_7 \cdot 2H_2O$ = g [1]

- (ii) A student places the mass of $Na_3C_6H_5O_7 \cdot 2H_2O$ calculated in (c)(i) into a beaker.

Describe how the student can prepare exactly 250.0 cm^3 of a solution of 1.0 mol dm^{-3} citrate ions from the sample in the beaker.

Give the name and capacity, in cm^3 , of any apparatus used.

.....

.....

.....

.....

..... [3]

(d) A different student records the following titration data in **Step 4**.

experiment	rough	1	2
final reading/cm ³	21.20	24.60	47.75
initial reading/cm ³	0.00	3.10	25.30
titre/cm ³	21.20	21.50	22.45

Identify the problem with the student's titration method **and** suggest how it could be improved.

.....

.....

.....

..... [2]

[Total: 13]



2 ASSESSMENT OF PLANNING SKILLS

Lithium is an alkali metal – one of a group of very reactive metals which are stored under oil to prevent contact with air and water vapour.

The reaction of lithium with water can be represented by the equation below.

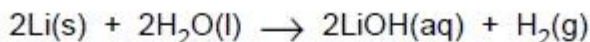

(a) In the space below, draw a diagram that clearly shows the apparatus you could use to:

- react a weighed amount of lithium metal with water,
- collect the hydrogen gas produced,
- measure the volume of gas produced.

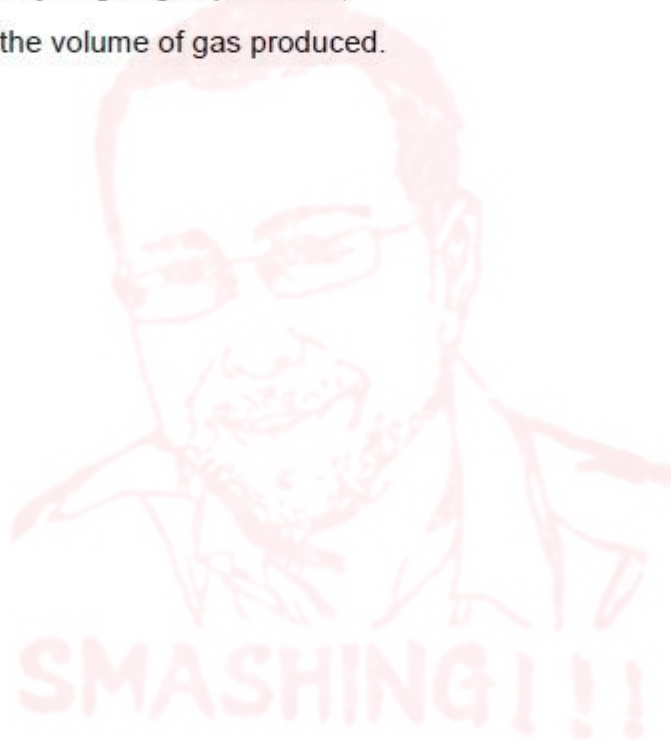

[2]

(b) What would you have to do before weighing lithium?

..... [1]

(c) Suggest and give a reason for one **safety** measure, related to the chemicals used or produced, that you would have to employ in conducting this experiment.

.....
..... [1]



- (d) If 0.0583 g of lithium produces 100 cm³ of hydrogen gas at room temperature and pressure show that the relative atomic mass, A_r , of lithium is approximately 7.
[$V_m = 24 \text{ dm}^3 \text{ mol}^{-1}$ under room conditions]

[3]

- (e) Give **two** reasons why the value of A_r calculated in (d) is approximate.

.....
.....
..... [2]

- (f) Using the aqueous lithium hydroxide remaining after the reaction, it is possible to obtain an 'accurate' value of A_r for lithium. What practical technique could be used to obtain this value?

..... [1]

- (g) Explain why the method you have used in (f) will give you a more accurate result.

.....
.....
..... [1]

[Total: 11]

3 ANALYSIS AND EVALUATION

(a) Indicate the size of the error you would expect in making measurements with the thermometer in question 2.

.....
.....
.....[1]

(b) Why is it **not** necessary to consider the errors in the measuring cylinder used in question 1?

.....
.....
.....[1]



- (d) For the experiment shown in the photograph, suggest **two other major** sources of error (not including that mentioned in part (c)) in the spaces provided on page 10.

For each source of error describe a method of reducing this error, explaining the reasoning for your method.

The data below may be relevant.

Data

Solubility of carbon dioxide gas at different temperatures

temperature / °C	solubility /g CO ₂ per 100 g of water
0	0.348
25	0.145
40	0.097
60	0.058

The general gas equation $pV = nRT$

The specific heat capacity of water = 4.18 J g⁻¹ K⁻¹

Vapour pressure of water at different temperatures

temperature / °C	Vapour pressure /Pa
20	2388
25	3167
30	4243
35	5623
40	7376

Technical data for X₂CO₃

Minimum assay	99%
Substances insoluble in water	0.0025%
Water	0.35%
Arsenic	0.0001%
Lead	0.003%
Sulphate	0.02%
Iron	0.001%

(i) first major source of error

.....

method for reducing this error

.....

.....

explanation

.....

..... [3]

(ii) second major source of error

.....

.....

method for reducing this error

.....

.....

explanation

.....

..... [3]

[Total : 10]

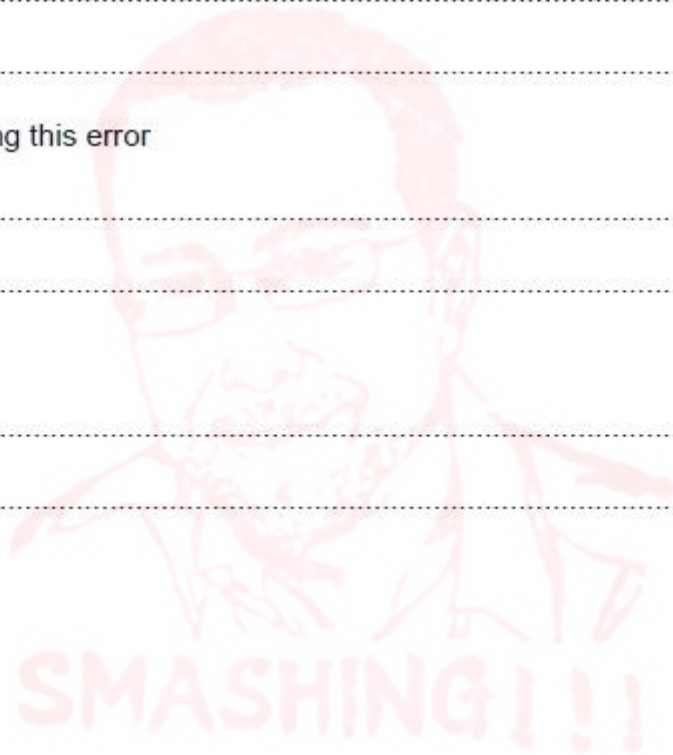

- 2 The variation of the volume with temperature of a fixed mass of an ideal gas at constant pressure may be represented by a relationship known as Charles's law,

$$V = kT$$

where V is the volume of a gas, T is the temperature in Kelvin and k is a constant.

An experiment was carried out to attempt to verify this law.

- A specially adapted gas syringe was filled with a sample of gas. The syringe was placed in a temperature controlled chamber at 25°C and left for 5 minutes. The initial volume of gas at this temperature was 26.0cm^3 .
- The temperature was adjusted and, after leaving for 5 minutes, the change in gas volume for the new temperature was recorded.
- The experiment was repeated several times at different temperatures and the results recorded.

- (a) The results of the experiment are recorded below.

Process the results in the table to calculate the volume of the gas and the corresponding temperature in Kelvin to enable you to plot a graph to show their inter-relationship.

(Note 0°C is 273K).

Record these values to **three significant figures** in the additional columns of the table. You may use some or all of the columns.

Label the columns you use. For each column you use include units where appropriate and an expression to show how your values are calculated.

You may use the column headings A to E in these expressions (e.g. A–B).

A	B	C	D	E
temperature of the gas / $^{\circ}\text{C}$	change in volume of the gas / cm^3			
-23	-4.20			
-4	-2.50			
11	-2.10			
29	0.40			
42	1.50			
63	3.30			
77	4.50			
94	7.00			
117	8.00			
131	9.20			

[2]



(b) Present the data calculated in (a) in graphical form. Draw the line of best fit.

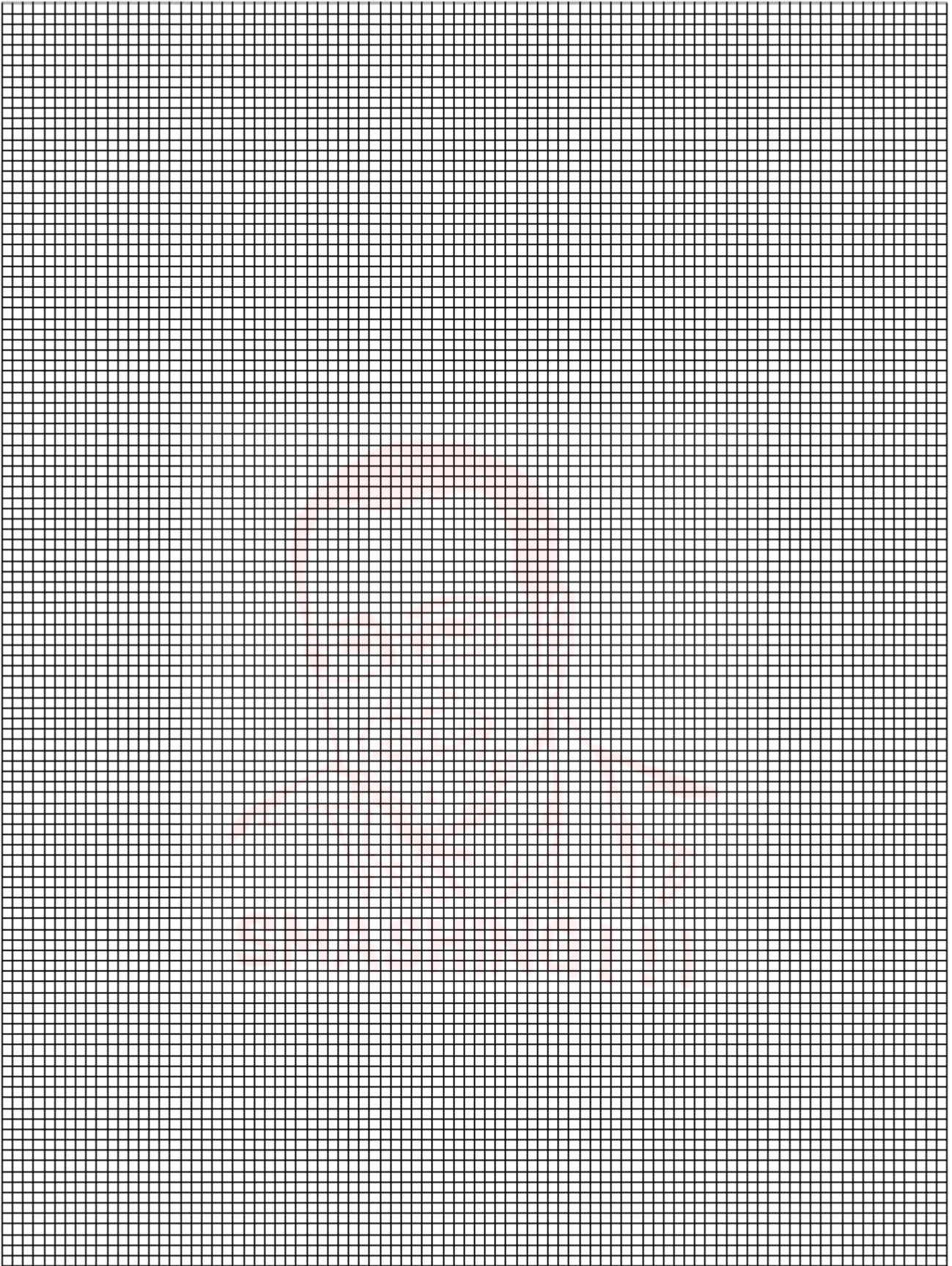

[3]



(f) Indicate whether the results do or do not confirm Charles's law.

.....

Give a reason for your answer.

.....

.....

.....

.....[2]

(g) As the pressure of a gas is reduced its volume increases. On your graph on page 6 draw another line showing how the volume varies with temperature if the experiment were repeated using the same fixed mass of gas at a lower pressure. [1]

[Total: 15]



1 It is possible to determine the relative molecular mass, M_r , of a small sample of a volatile liquid by measuring its mass and then heating to vaporise it to obtain its volume as a gas.

(a) Explain how the relative molecular mass can be determined in this way.

.....
.....
.....
..... [2]

(b) (i) The volume of the vaporised sample depends on its temperature and pressure.

In an experiment, a sample of volatile liquid of known mass was vaporised and its volume recorded. The pressure was correctly recorded as 101 kPa but the temperature was incorrectly recorded as 50 °C. The correct temperature was 60 °C.

By considering the effect of these different temperatures on the gas volume, explain how the value of the calculated M_r would be affected.

.....
.....
.....
.....
..... [3]

(ii) The temperature was maintained at 60 °C but the pressure was increased to 110 kPa. Would this have given an answer that was nearer to the true value of the relative molecular mass? Explain your answer.

.....
.....
..... [1]



In an experiment to determine the relative molecular mass of hexane, boiling point 69 °C, a specialist piece of apparatus called a Victor Meyer tube can be used. This consists of a long tube with a bulb at the base in which a sample can be vaporised. The tube has a side arm to allow the escape of gas from within the tube. The tube is surrounded by another which can be used to heat the contents of the first tube.

A diagram of the apparatus is shown below.

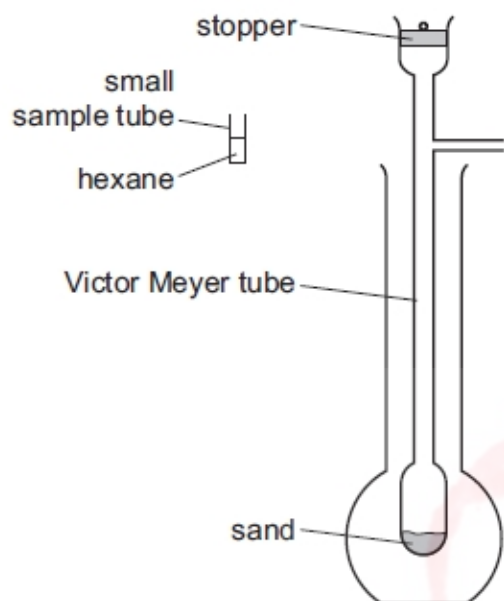

A small sample tube containing the hexane is inserted at the top of the Victor Meyer tube. The sample tube is small enough to fit inside the Victor Meyer tube and falls freely onto the hot sand below. The sand will cushion its fall so that the sample tube does not break. The stopper is then quickly replaced at the top of the Victor Meyer tube. The hot sand causes the hexane to vaporise and expel air contained in the Victor Meyer tube.

(c) Complete the diagram above to show:

- how the apparatus should be heated,
- a connection to further apparatus which would allow the air expelled from the Victor Meyer tube when the sample of hexane is vaporised to be collected and measured.

[2]

(d) Suggest **one** hazard associated with the use of hexane.

.....
..... [1]

(e) (i) With the gas collection apparatus connected to the heated Victor Meyer tube, expelled air will be collected before the hexane is introduced. Explain why.

.....
.....
.....
..... [2]

(ii) At which stage of the experimental procedure should the sample tube be dropped into the Victor Meyer tube?

.....
..... [1]

(f) State what measurements you would need to make in order to determine the relative molecular mass of hexane.

.....
.....
.....
..... [3]

[Total: 15]

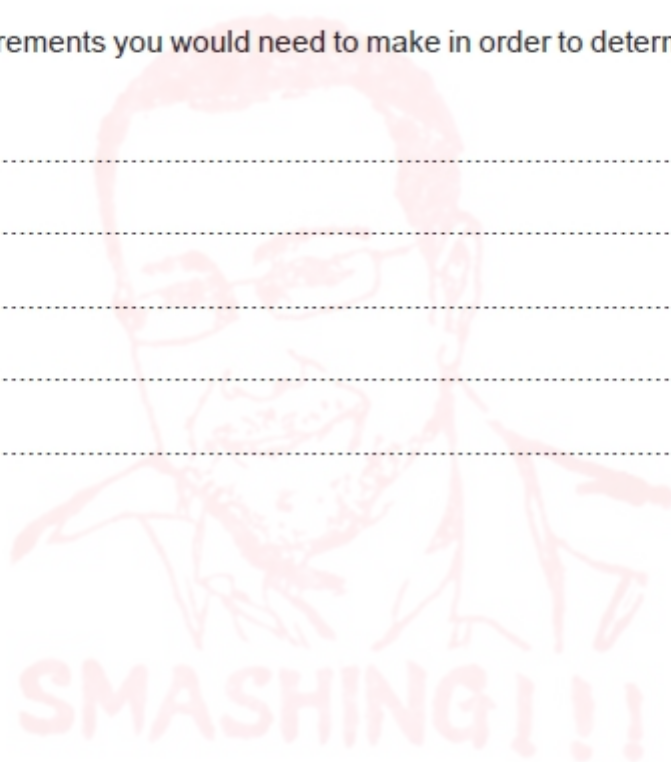

- 2 At high temperatures a mixture of iodine and hydrogen gases reacts to form an equilibrium with gaseous hydrogen iodide.

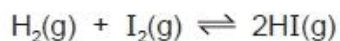

- (a) (i) Write an expression for the equilibrium constant, K_c , based on concentration, for this reaction.

[1]

- (ii) If the starting concentration of both iodine and hydrogen was $a \text{ mol dm}^{-3}$ and it was found that $2y \text{ mol dm}^{-3}$ of hydrogen iodide had formed once equilibrium had been established, write K_c in terms of a and y .

[1]

- (b) The expression for the equilibrium constant from (a)(ii) can be re-written as shown below.

$$y = \frac{a\sqrt{K_c}}{2 + \sqrt{K_c}}$$

In an experiment, air was removed from a 1 dm^3 flask and amounts of hydrogen and iodine gases were mixed together such that their initial concentrations were both $a \text{ mol dm}^{-3}$. This mixture was allowed to come to equilibrium at 760 K in the flask. The equilibrium concentration of iodine, $(a - y) \text{ mol dm}^{-3}$, was then measured.

The experiment was repeated for various initial concentrations, $a \text{ mol dm}^{-3}$, and the results were recorded in the table below.

- (i) Complete the table to give the values of $y \text{ mol dm}^{-3}$ to **three decimal places**.

$a \text{ mol dm}^{-3}$	$(a - y) \text{ mol dm}^{-3}$	$y \text{ mol dm}^{-3}$
0.200	0.022	0.178
0.500	0.050	
0.800	0.252	
1.000	0.200	
1.500	0.365	
2.100	0.570	
2.800	0.652	
3.400	0.700	
3.800	0.867	
4.200	0.868	
4.900	1.150	

[2]



(ii) Plot a graph to show how $y \text{ mol dm}^{-3}$ varies with initial concentrations of hydrogen and iodine, $a \text{ mol dm}^{-3}$.

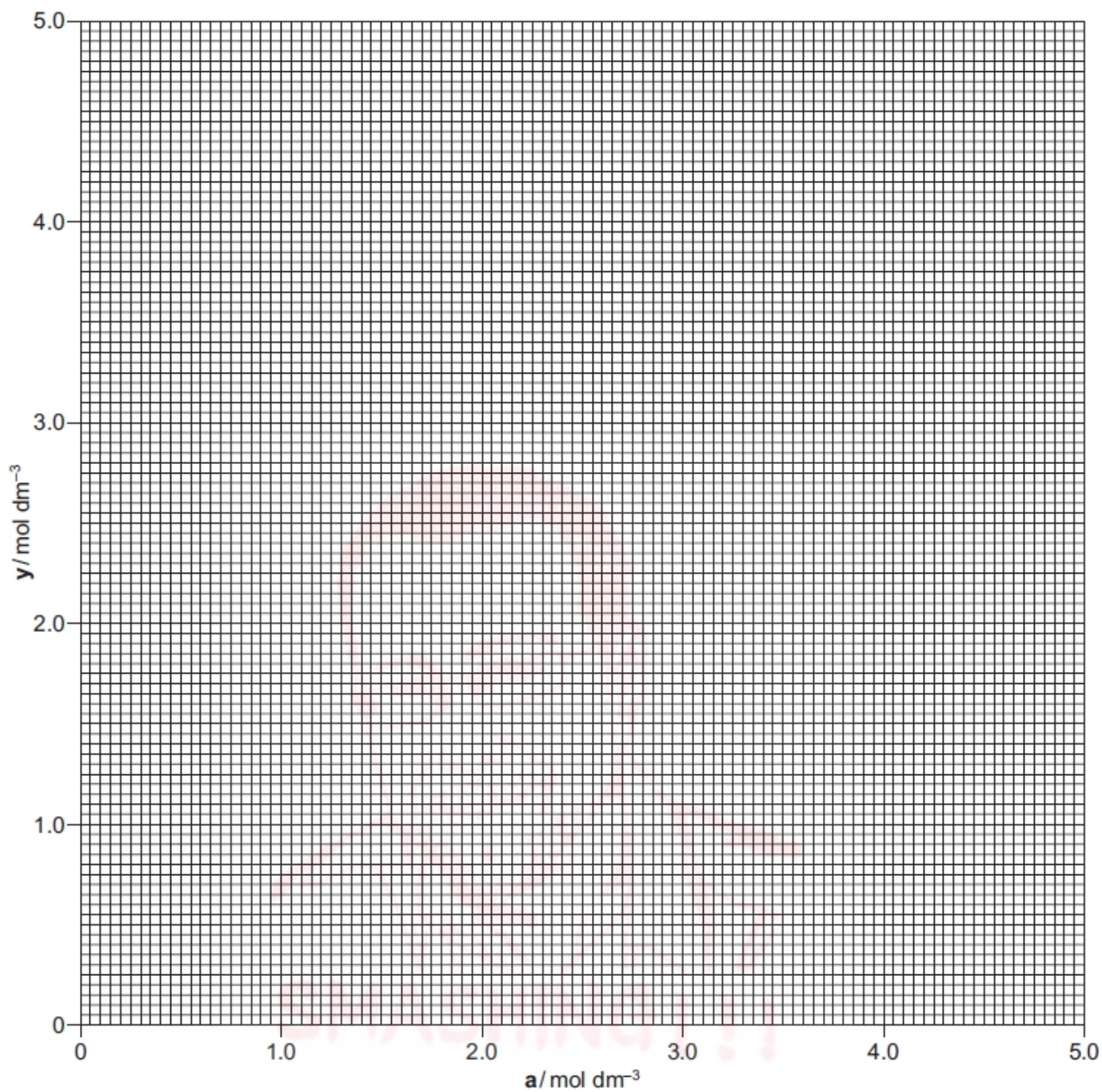

[1]

(iii) Use your points to draw a line of best fit.

[1]

- (c) (i) Determine the slope of your graph. State the co-ordinates of both points you used for your calculation. Record the value of the slope to **three significant figures**.

co-ordinates of both points used

slope =

[2]

- (ii) Use the value of your slope and the equation in (b) to calculate the value of K_c . Your working **must** be shown.

[2]

- (d) Explain why, for safety reasons, it is necessary to remove air from the 1 dm³ flask.

.....
..... [1]

- (e) One of the experiments in (b) was repeated in a 500 cm³ flask instead of the 1 dm³ flask.

What effect, if any, would this have on the rate of reaction and the value of K_c measured?

.....
.....
.....
.....
..... [2]

(f) The reaction of hydrogen and iodine to form hydrogen iodide is exothermic.

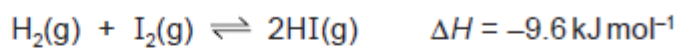

(i) On your graph, draw and label the line you would expect if the experiment was performed at 1000 K instead of 760 K. [1]

(ii) What effect, if any, would the higher temperature have on the value of K_c ?

.....
..... [1]

[Total: 15]



- 2 Nitrogen dioxide can be prepared by strongly heating anhydrous lead nitrate, $\text{Pb}(\text{NO}_3)_2(\text{s})$. The thermal decomposition occurs according to the equation shown.

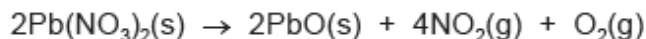

The nitrogen dioxide, NO_2 , can be separated from the oxygen by cooling the gas mixture produced until the NO_2 condenses and the oxygen does not.

	melting point/K	boiling point/K
nitrogen dioxide	262	294
oxygen	54	90

- (a) Draw a labelled diagram of the laboratory apparatus (assembled) that could be used to prepare **liquid** nitrogen dioxide from the thermal decomposition of anhydrous lead nitrate.

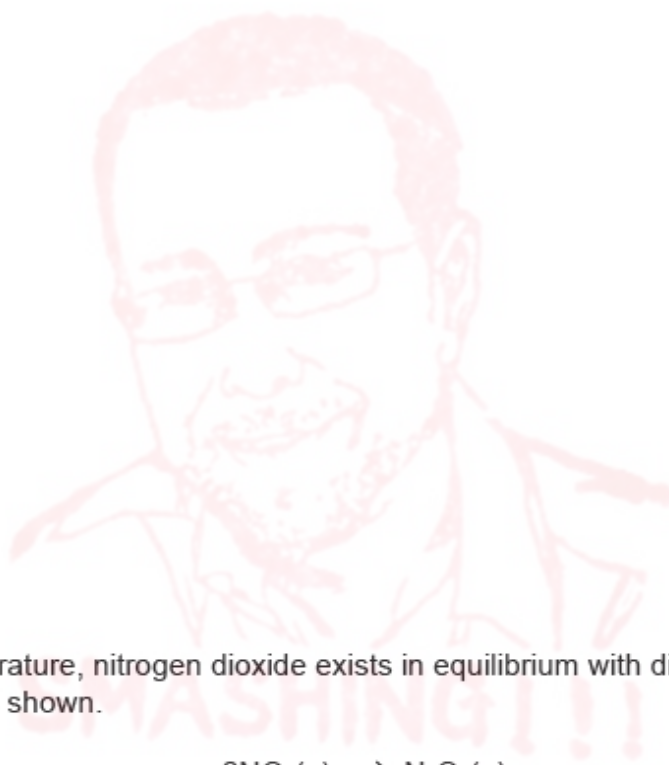

[2]

- (b) At room temperature, nitrogen dioxide exists in equilibrium with dinitrogen tetroxide according to the equation shown.

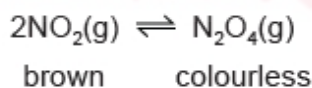

For this equilibrium, $K_p = p_{\text{N}_2\text{O}_4} / p_{\text{NO}_2}^2$.

$p_{\text{N}_2\text{O}_4}$ and p_{NO_2} are measured in kPa.

State the units of K_p .

..... [1]

A student plans to investigate the variation of K_p with temperature.

- (c) (i) A sample of the mixture of nitrogen oxides is introduced into a gas syringe at 295K and the gas syringe is sealed so that it is both airtight and watertight. The volume occupied by the mixture is measured at different temperatures. The K_p value is calculated at each temperature.

Name the apparatus you would use to heat the gas syringe at different temperatures between 295K and 370K so that a volume reading of the gas syringe could be easily taken.

..... [1]

- (ii) The results obtained are shown in the table.

Complete the table by calculating values for $\frac{1}{T}$ and $\log K_p$.

Record the value of $\frac{1}{T}$ to **three significant figures**.

Record the value of $\log K_p$ to **two decimal places**.

T/K	$\frac{1}{T}/K^{-1}$	K_p	$\log K_p$
377		0.076	
361		0.122	
344		0.257	
330		0.741	
315		1.506	
312		3.490	
295		9.025	

[2]

- (iii) Plot a graph on the grid of $\log K_p$ against $\frac{1}{T}$.

Draw a line of best fit through the plotted points.

[2]

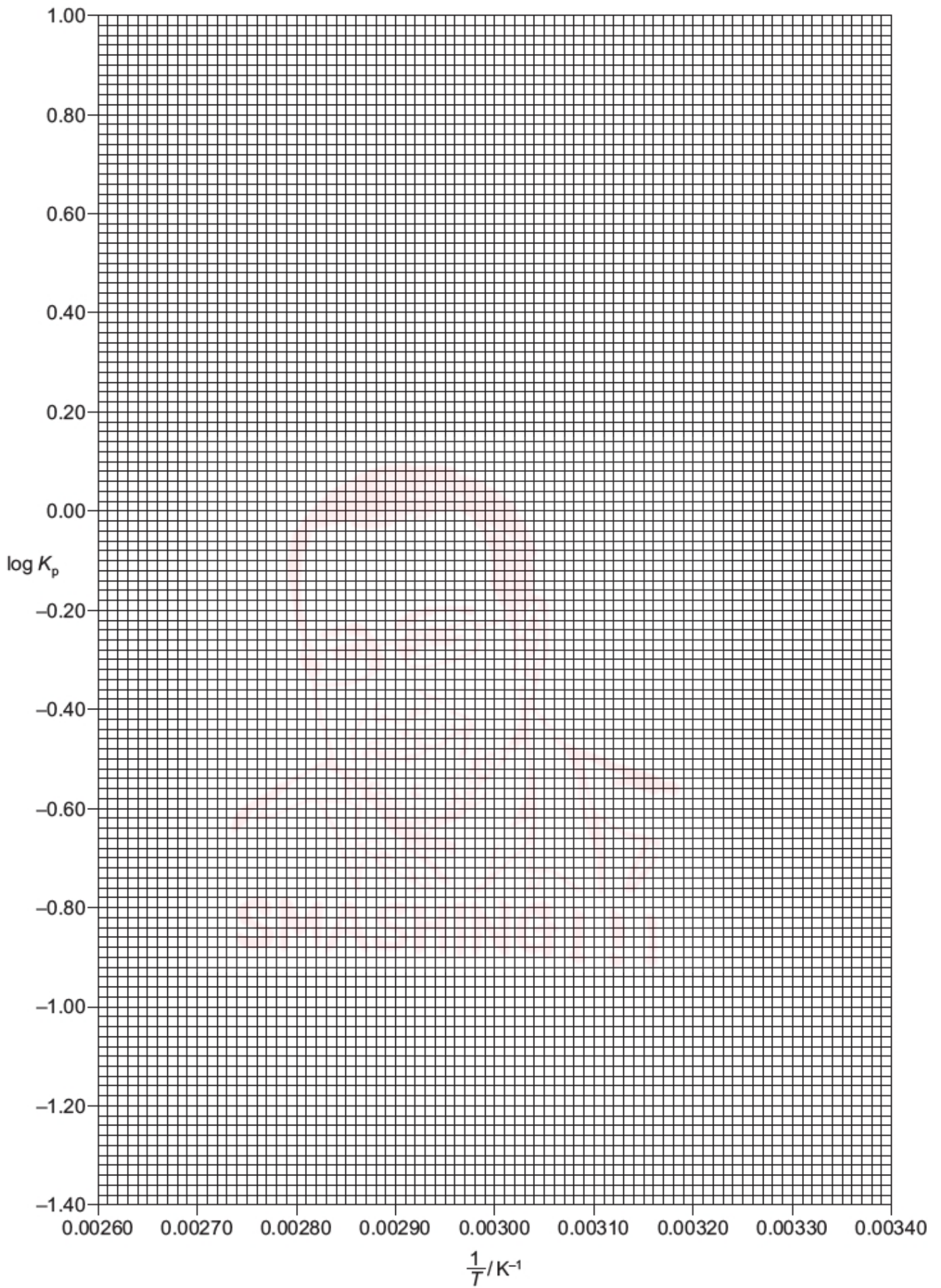

(d) (i) State and explain what your graph shows about the accuracy of the experimental results.

.....
.....
..... [1]

(ii) Suggest a reason for your answer in (d)(i).

.....
..... [1]

(iii) Suggest what the student could do to improve the accuracy of the experiment.

.....
..... [1]

(e) (i) Use the graph to determine the gradient of the line of best fit.

State the coordinates of both points you used in your calculation. These must be on your line of best fit.

Give your answer to **three significant figures**.

coordinates 1 coordinates 2

gradient = K
[2]

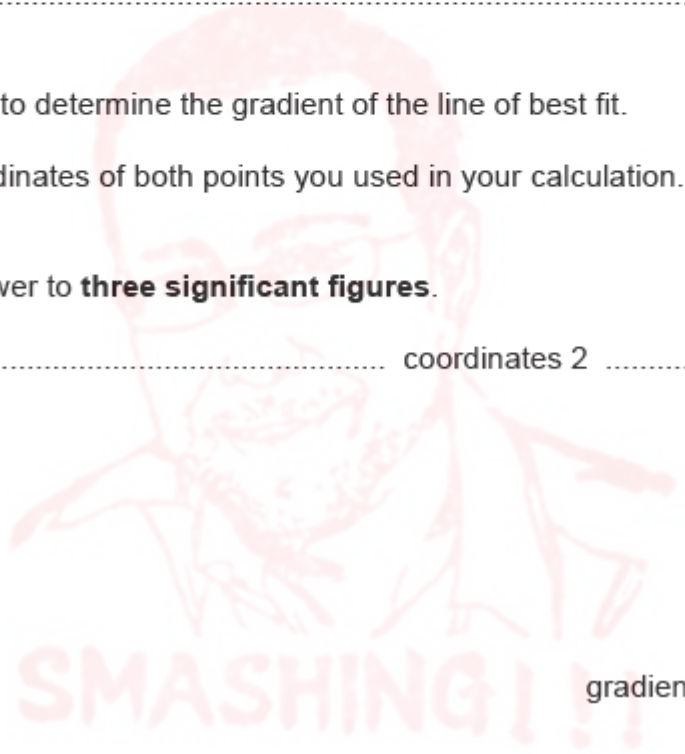

- (ii) The relationship between $\log K_p$ and $\frac{1}{T}$ is given by the equation shown.

$$\log K_p = (-\Delta H/2.303RT) + \text{constant}$$

$$R = 8.31 \text{ JK}^{-1} \text{ mol}^{-1}$$

Use the gradient determined to calculate a value for ΔH .

If you were unable to determine a value for the gradient, use the value 2800 K. This is **not** the correct value.

$$\Delta H = \dots\dots\dots \text{ kJ mol}^{-1}$$

[2]

- (f) (i) With reference to the results obtained in this experiment, state and explain how K_p varies with temperature.

.....
..... [2]

- (ii) With reference to (b) and the data for K_p in the table in (c)(ii) suggest how the colour of the equilibrium mixture at 370 K will differ, if at all, from the colour at room temperature. Explain your answer.

difference in colour of mixture

explanation

.....
..... [2]

[Total: 19]



- 1 Lithium is a soft alkali metal which may be cut with a knife. It is usually stored under oil because it reacts rapidly with moisture and oxygen in the air.

Lithium is **corrosive** and may cause burns.

Lithium is **highly flammable** and in large amounts reacts violently with water.

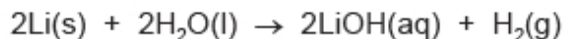

This reaction can be used to determine the relative atomic mass of lithium by measuring the volume of hydrogen produced from a small amount of lithium.

- (a) Draw the apparatus you could use to measure the volume of hydrogen produced, using standard laboratory equipment.

Label the chemicals in your diagram and show how the reactants can be kept apart until the reaction is started.



[3]

(b) To successfully carry out this experiment a correct procedure must be followed. The lithium you will use is stored as large pieces under oil.

(i) Beginning with a large piece of lithium being removed from the oil, state how you would prepare a small piece of lithium for use in this experiment.

.....
..... [1]

(ii) By only observing the gas collecting apparatus, state how you would know the reaction had stopped.

.....
..... [1]

(iii) Other than eye protection, state two precautions you would take to make sure that the experiment proceeds safely.

1.
.....
2.
..... [2]

(iv) The relative atomic mass of lithium is known to be approximately 7.

What approximate volume of hydrogen gas would a 0.1 g mass of lithium produce?

(1 mol of gas occupies 24.0 dm³ at room temperature and pressure.)

volume of H₂(g) produced [1]

(v) What would be the capacity (volume) of the gas collecting apparatus you would use for the volume of hydrogen produced in **(iv)**?

volume of gas collecting apparatus [1]



- (c) Another method that can be used to determine the relative atomic mass of lithium is by titration of the lithium hydroxide produced during its reaction with water.

The following experimental procedure may be used.

1. Add 100.0 cm³ of distilled water to a clean beaker.
2. Add a known mass of lithium to the distilled water.
3. After the reaction is complete, transfer 25.0 cm³ of the solution of lithium hydroxide from the beaker to a clean conical flask.
4. Titrate this with an acid of known concentration.

- (i) State how you would accurately measure the total volume of distilled water in step 1.

..... [1]

- (ii) State how you would know that the reaction between lithium and distilled water was complete.

..... [1]

- (iii) State how you would transfer 25.0 cm³ of the solution of lithium hydroxide into a clean conical flask in step 3.

..... [1]

- (iv) State how you would ensure that your titration result was reliable.

..... [1]

- (d) To make sure that the beaker and the conical flask used in the experimental procedure in (c) are clean, a student decides to wash them out with some distilled water before starting the experiment.

Some water remains in the beaker. State the effect, if any, this would have on the calculated relative atomic mass of lithium. Explain your reasoning.

.....
.....
.....

Some water remains in the conical flask. State the effect, if any, this would have on the calculated relative atomic mass of lithium. Explain your reasoning.

.....
.....
.....

[2]

[Total: 15]

- 2 A student uses the apparatus shown to calculate the relative molecular mass, M_r , of a gaseous alkane. The experiment took place at 298 K and 101 kPa.

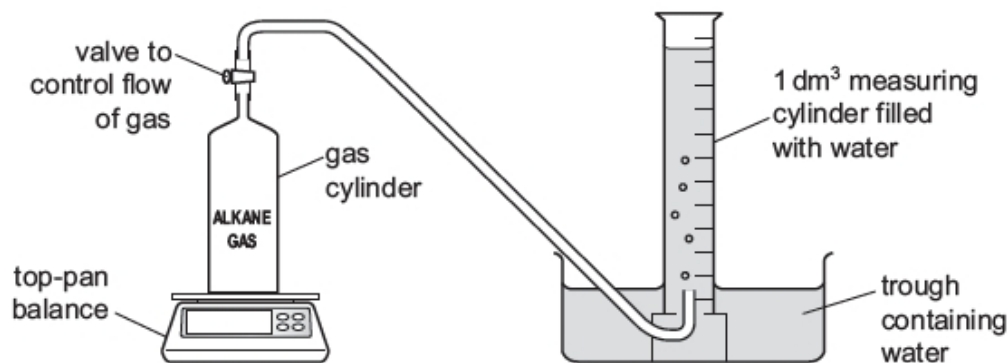

The alkane is flammable.

The student opens the tap and allows a small amount of the alkane gas into the measuring cylinder, displacing water. The gas in the measuring cylinder is allowed to reach room temperature and the volume recorded. This process is repeated and the measurements of mass of gas cylinder and total volume of gas collected are recorded in the table.

A	B	C
mass of gas cylinder/g	total volume of gas collected/cm ³	total mass of gas lost from the cylinder/g
164.02	0	0.00
163.77	100	
163.65	150	
163.48	230	
163.26	320	
163.02	420	
162.72	550	
162.38	720	
162.11	800	
161.83	930	

- (a) Complete column C in the table. The first reading has been done for you. Give all values to **two decimal places**. [1]
- (b) (i) Plot a graph on the grid of total mass of gas lost against the total volume of gas collected. Use a cross (x) to plot each data point. Draw a line of best fit.

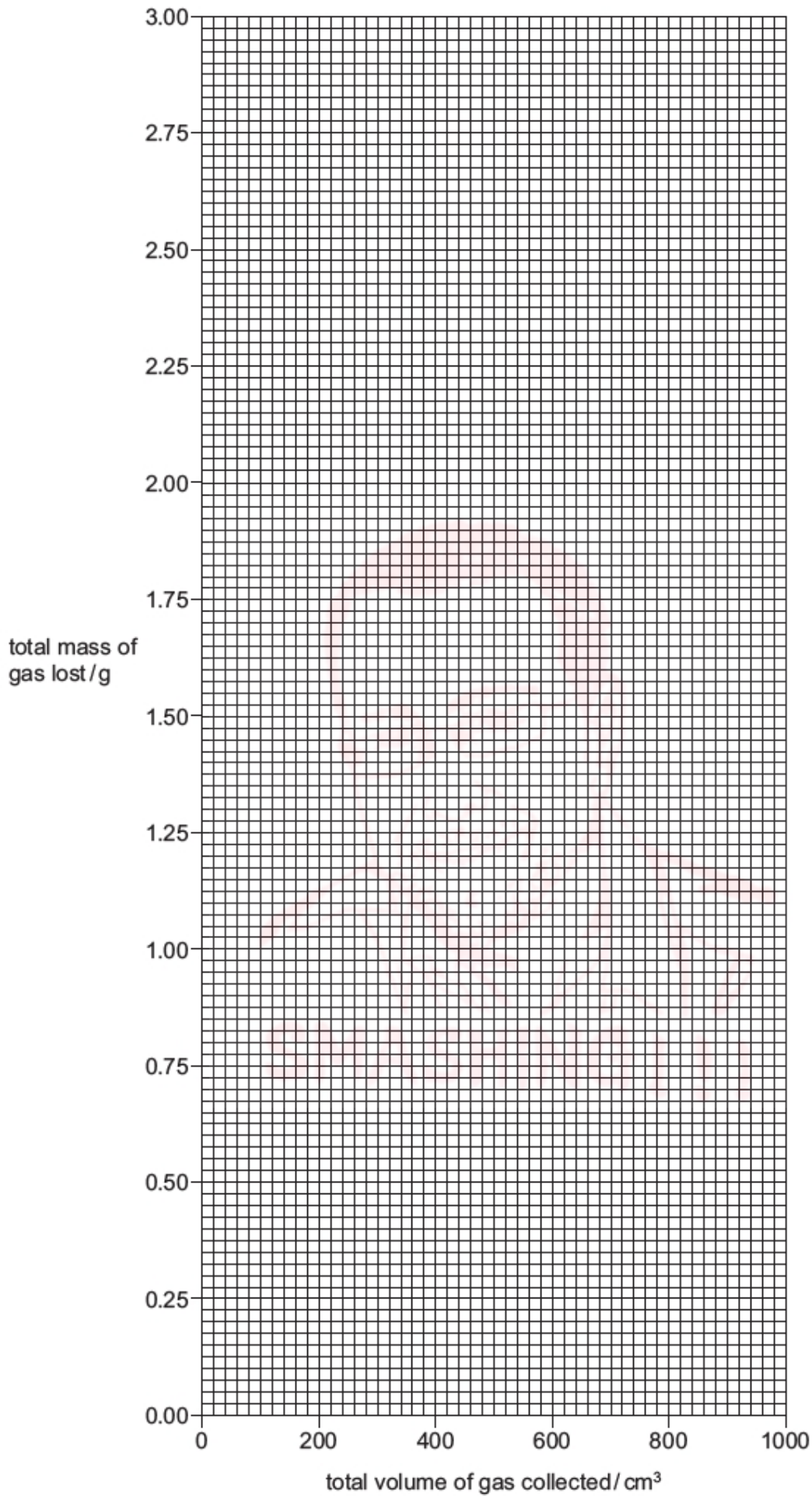

[2]



(ii) Circle the point which you think is most anomalous on your graph. [1]

(iii) Suggest **one** reason that explains the anomalous result you have circled.

.....
..... [1]

(c) (i) Use the graph to determine the gradient of the line of best fit.

State the coordinates of both points you used in your calculation. These must be selected from your line of best fit.

Give the gradient to **three significant figures**.

coordinates 1 coordinates 2

gradient = g cm^{-3}
[2]

(ii) The ideal gas equation states that $pV = nRT$, where $R = 8.31 \text{ J mol}^{-1} \text{ K}^{-1}$.

Use the ideal gas equation and your answer to (c)(i) to calculate an experimental value for the M_r of the alkane gas.

Give your answer to **one decimal place**. Show your working.

$M_r =$ [2]

(iii) Suggest the identity of the alkane gas. Explain your suggestion.

.....
..... [1]

(d) (i) Suggest **two** ways in which the accuracy of the measurements may be improved.

.....
.....
..... [2]

(ii) Apart from wearing eye protection or a lab coat, state **one** safety precaution which the student must take when carrying out this experiment.

..... [1]

(iii) The student is told that samples of the alkane gas are sometimes contaminated with a more volatile alkane.

State and explain how this would affect the gradient of the graph.

.....
.....
..... [2]

(iv) In each experiment the gas was allowed to reach the temperature of the room (298 K) before the volume was measured.

Explain why this was necessary for the calculation of the M_r of the alkane.

.....
..... [1]

(v) Suggest how the reliability of the experiment could be improved.

..... [1]

[Total: 17]

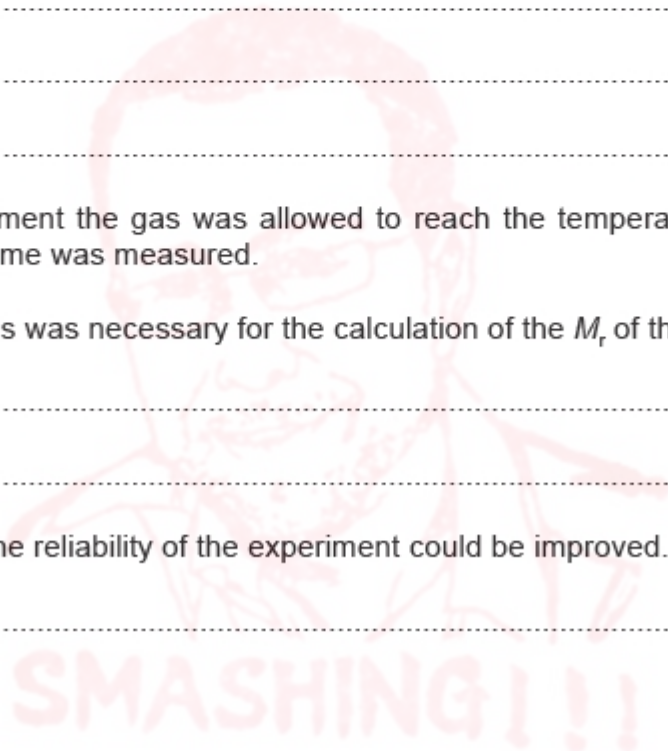

2 ASSESSMENT OF PLANNING SKILLS

DO NOT CARRY OUT YOUR PLAN

Caesium nitrate, CsNO_3 , decomposes on heating.

The decomposition is represented by one of the following equations.

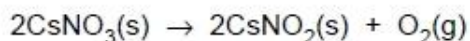
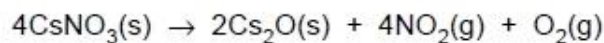

You are to devise a method of heating the solid nitrate, collecting the gas given off and measuring its volume.

From the experimental results you are to determine which is the correct equation for the decomposition.

Information that may be used in the question.

The molar volume of gas, V_m , is $24.0 \text{ dm}^3 \text{ mol}^{-1}$ under room conditions.

Nitrogen dioxide, NO_2 , a toxic gas, is soluble in water.

Oxygen, O_2 , is not soluble in water.

[A_r : Cs, 133.0; N, 14.0; O, 16.0.]

- (a) Draw and label the apparatus you would use to heat the caesium nitrate, to collect the gas and to measure its volume.

When labelling your diagram include the volume of apparatus used (e.g. 250 cm^3 beaker) where appropriate. [2]

1 You are to plan an investigation into the thermal decomposition of caesium nitrate, CsNO_3 .

You may make use of some or all of the following data when planning your investigation.

Group I element	cation	ionic radius / nm
lithium	Li^+	0.060
sodium	Na^+	0.095
potassium	K^+	0.133
rubidium	Rb^+	0.148
caesium	Cs^+	0.176

Equations for the thermal decomposition of lithium nitrate and sodium nitrate are given below.

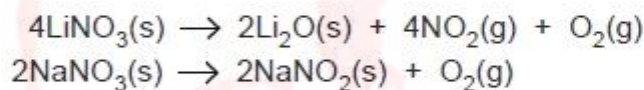

nitrogen dioxide gas	oxygen gas
NO_2	O_2
brown in colour	colourless
soluble in water	almost insoluble in water
poisonous	powerful oxidant

1 mol of any gas occupies a volume of approximately 24 dm^3 at room temperature and atmospheric pressure.

A_r : Cs, 133; N, 14.0; O, 16.0

(a) Predict which of the equations below will represent the thermal decomposition of caesium nitrate. Place a tick against the equation of your choice.

$4\text{CsNO}_3(\text{s}) \rightarrow 2\text{Cs}_2\text{O}(\text{s}) + 4\text{NO}_2(\text{g}) + \text{O}_2(\text{g})$	
$2\text{CsNO}_3(\text{s}) \rightarrow 2\text{CsNO}_2(\text{s}) + \text{O}_2(\text{g})$	

Use data provided on page 2 to explain your prediction.

.....

.....

.....

.....

..... [2]

(b) You are to plan an experiment in which

- caesium nitrate is heated,
- gas is collected,
- the volume of gas collected is measured,
- the experimental results are used in a calculation to confirm or reject your prediction.

(i) Identify the independent variable in the experiment.

.....

(ii) Identify the dependent variable in the experiment.

..... [2]

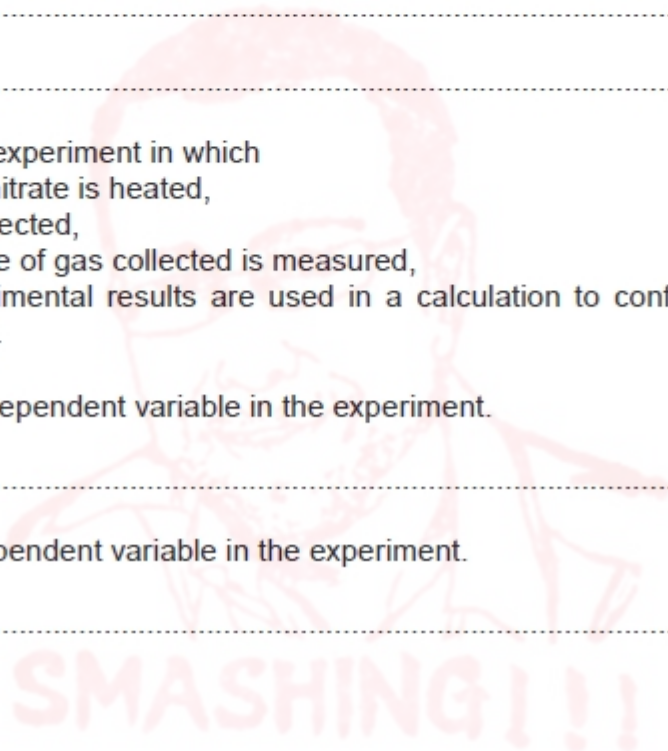

- (c) Draw a diagram of the apparatus you would use in this experiment. Your apparatus should use only standard items found in a school or college laboratory. Show clearly how the solid will be heated, the gas collected and its volume measured. Label each piece of apparatus used, indicating its size or capacity, e.g. 250 cm^3 beaker.

Assuming that either equation in (a) might be correct, which gas or gases would you expect to collect in your apparatus. Explain your answer.

.....
..... [3]

- (d) Calculate the volume of gas you would expect to collect in your apparatus if 1 mol of caesium nitrate completely decomposed according to your predicted equation in (a).

[1]

(g) What should be done when decomposition is complete to ensure that the volume of gas measured in the apparatus is the "correct" volume?

.....
..... [1]

(h) Identify a risk present in the method you have described.

.....
.....

Describe how you would minimise this risk.

.....
..... [2]

[Total: 15]

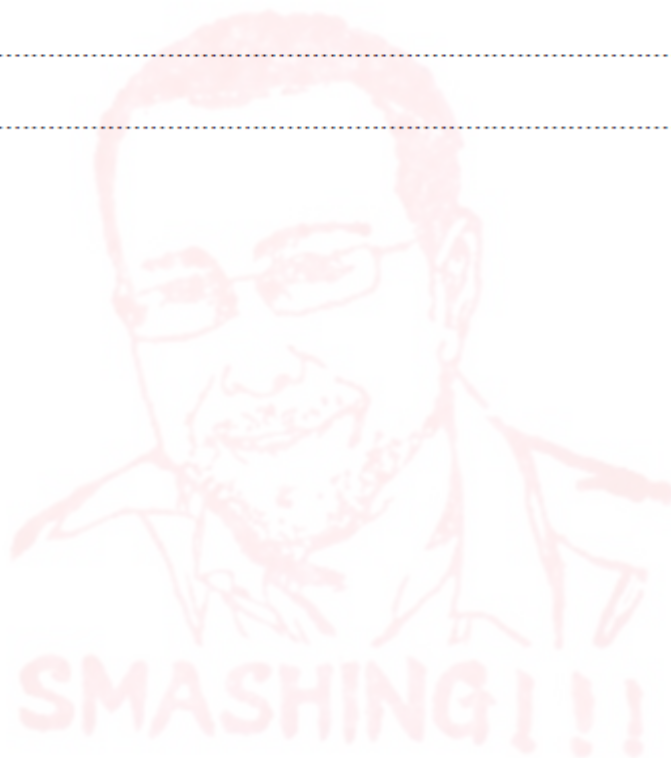

1 The carbonates of group II in the periodic table decompose on heating forming an oxide and carbon dioxide.

X is any group II cation (e.g. Mg^{2+})

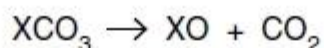

This decomposition occurs because the positively charged cations polarise (distort) the C—O bond in the carbonate ion causing the ion to break up. The charge density of the group II cations decreases down the group. This affects the decomposition rate.

You are to plan an experiment to investigate how the rate of decomposition of a group II carbonate varies as the group is descended. The rate can be conveniently measured by finding the time taken to produce the same volume of carbon dioxide from each carbonate.

(a) (i) Predict how the rate of decomposition of the group II carbonates will change as the group is descended.

Explain this prediction in terms of the charge density of the cation as the group is descended.

prediction

.....

.....

explanation

.....

.....

.....

(ii) Display your prediction in the form of a sketch graph, clearly labelling the axes.

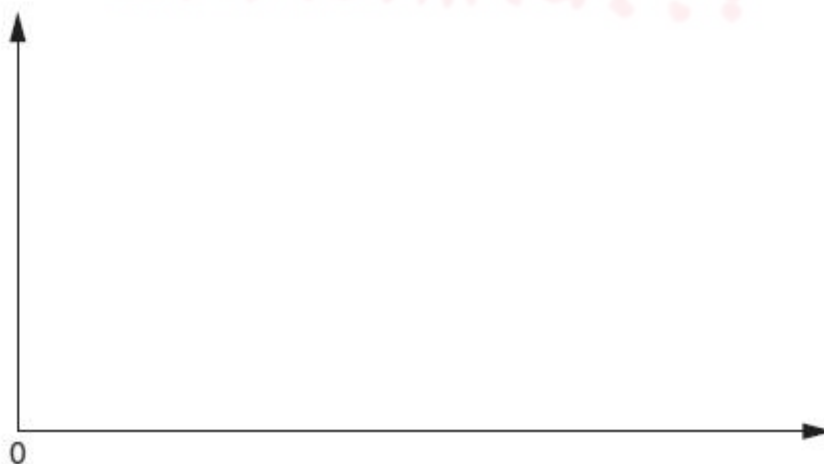

[3]



(b) In the experiment you are about to plan, identify the following.

(i) the independent variable

(ii) the dependent variable

[2]

(c) Draw a diagram of the apparatus and experimental set up you would use to carry out this experiment. Your apparatus should use only standard items found in a school or college laboratory and show clearly the following.

(i) the apparatus used to heat the carbonate

(ii) how the carbon dioxide will be collected

Label each piece of apparatus used, indicating its size or capacity.



[2]

- (e) State a hazard that must be considered when planning the experiment and describe precautions that should be taken to keep risks to a minimum.

.....
.....
.....[2]

- (f) Draw a table with appropriate headings to show the data you would record when carrying out your experiments and the values you would calculate in order to construct a graph to support or reject your prediction in (a). The headings **must** include the appropriate units.

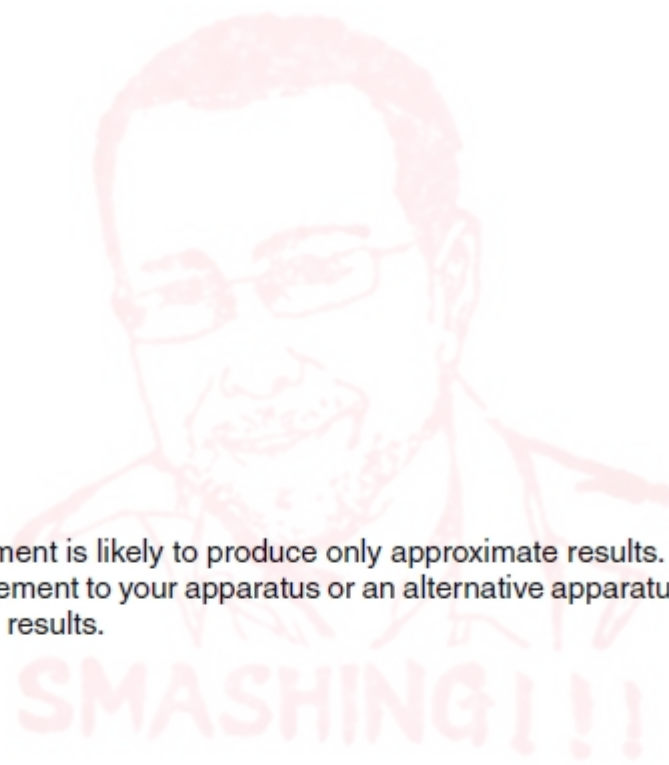

[2]

- (g) This simple experiment is likely to produce only approximate results. Suggest an improvement to your apparatus or an alternative apparatus that may improve the reliability of the results.

[1]

[Total: 16]



- 1 When magnesium nitrate(V) is heated, it decomposes to form magnesium oxide, nitrogen(IV) oxide and oxygen.

Nitrogen(IV) oxide is an acidic gas that reacts readily and completely with alkalis.

You are to plan a **single** experiment to confirm that the molar quantities of magnesium oxide, nitrogen(IV) oxide and oxygen produced agree with the equation for the thermal decomposition of magnesium nitrate(V).

The following information gives some of the hazards associated with nitrogen(IV) oxide.

Nitrogen(IV) oxide must not be inhaled. A large dose can be fatal and smaller quantities can have severe effects on breathing, particularly for people who suffer from asthma.

You are provided with anhydrous magnesium nitrate(V) and have access to the usual laboratory equipment and reagents.

- (a) (i) Write an equation for the thermal decomposition of magnesium nitrate(V).

..... [1]

- (ii) Calculate the mass of magnesium oxide and volumes of nitrogen(IV) oxide and oxygen produced under room conditions when 1 mole of magnesium nitrate(V) is heated.

[A_r : O, 16.0; Mg, 24.3]

You should assume that one mole of any gas occupies 24.0 dm^3 under room conditions.

[1]

- (b) (i) Draw and label a diagram of the apparatus and experimental set-up you would use. The set-up needs to be capable of absorbing the nitrogen(IV) oxide and collecting the oxygen separately and in sequence.

[4]

- (ii) State the volume of the gas collector to be used to collect oxygen in (i). Calculate a mass of magnesium nitrate(V) to be heated that would produce a stated volume of oxygen appropriate for the collector.

[A_r : N, 14.0; O, 16.0; Mg, 24.3]

You should assume that one mole of any gas occupies 24.0 dm^3 under room conditions.

[1]

(c) List the measurements you would make when carrying out the experiment.

.....

.....

.....

.....

.....

.....

..... [3]

(d) (i) How could you make sure that the magnesium nitrate(V) had completely decomposed in the experiment?

.....

.....

..... [1]

(ii) To make sure that the volume of gas measured is accurate, what should you do before taking the measurement?

.....

..... [1]

(e) Explain how you would use the results of the experiment to confirm that the decomposition had occurred according to the molar ratios in the equation.

.....

.....

.....

.....

.....

..... [2]



(f) What precautions would you take to make sure that the experiment could be performed safely?

.....

.....

.....

..... [1]

[Total: 15]



Results of Tests Carried out

Identity of solids dissolved in the solutions

FB 5	
FB 6	
FB 7	

[Total 5]

QUALITATIVE ANALYSIS NOTES

[Key: ppt. = precipitate]

1 Reactions of aqueous cations

ion	reaction with	
	NaOH(aq)	NH ₃ (aq)
aluminium, Al ³⁺ (aq)	white ppt. soluble in excess	white ppt. insoluble in excess
ammonium, NH ₄ ⁺ (aq)	ammonia produced on heating	
barium, Ba ²⁺ (aq)	no ppt. (if reagents are pure)	no ppt.
calcium, Ca ²⁺ (aq)	white ppt. with high [Ca ²⁺ (aq)]	no ppt.
chromium(III), Cr ³⁺ (aq)	grey-green ppt. soluble in excess giving dark green solution	grey-green ppt. insoluble in excess
copper(II), Cu ²⁺ (aq)	pale blue ppt. insoluble in excess	blue ppt. soluble in excess giving dark blue solution
iron(II), Fe ²⁺ (aq)	green ppt. insoluble in excess	green ppt. insoluble in excess
iron(III), Fe ³⁺ (aq)	red-brown ppt. insoluble in excess	red-brown ppt. insoluble in excess
lead(II), Pb ²⁺ (aq)	white ppt. soluble in excess	white ppt. insoluble in excess
magnesium, Mg ²⁺ (aq)	white ppt. insoluble in excess	white ppt. insoluble in excess
manganese(II), Mn ²⁺ (aq)	off-white ppt. insoluble in excess	off-white ppt. insoluble in excess
zinc, Zn ²⁺ (aq)	white ppt. soluble in excess	white ppt. soluble in excess

[Lead(II) ions can be distinguished from aluminium ions by the insolubility of lead(II) chloride.]

2 Reactions of anions

<i>ion</i>	<i>reaction</i>
carbonate, CO_3^{2-}	CO_2 liberated by dilute acids
chromate(VI), $\text{CrO}_4^{2-}(\text{aq})$	yellow solution turns orange with $\text{H}^+(\text{aq})$; gives yellow ppt. with $\text{Ba}^{2+}(\text{aq})$; gives bright yellow ppt. with $\text{Pb}^{2+}(\text{aq})$
chloride, $\text{Cl}^-(\text{aq})$	gives white ppt. with $\text{Ag}^+(\text{aq})$ (soluble in $\text{NH}_3(\text{aq})$); gives white ppt. with $\text{Pb}^{2+}(\text{aq})$
bromide, $\text{Br}^-(\text{aq})$	gives cream ppt. with $\text{Ag}^+(\text{aq})$ (partially soluble in $\text{NH}_3(\text{aq})$); gives white ppt. with $\text{Pb}^{2+}(\text{aq})$
iodide, $\text{I}^-(\text{aq})$	gives yellow ppt. with $\text{Ag}^+(\text{aq})$ (insoluble in $\text{NH}_3(\text{aq})$); gives yellow ppt. with $\text{Pb}^{2+}(\text{aq})$
nitrate, $\text{NO}_3^-(\text{aq})$	NH_3 liberated on heating with $\text{OH}^-(\text{aq})$ and Al foil
nitrite, $\text{NO}_2^-(\text{aq})$	NH_3 liberated on heating with $\text{OH}^-(\text{aq})$ and Al foil, NO liberated by dilute acids (colourless $\text{NO} \rightarrow$ (pale) brown NO_2 in air)
sulphate, $\text{SO}_4^{2-}(\text{aq})$	gives white ppt. with $\text{Ba}^{2+}(\text{aq})$ or with $\text{Pb}^{2+}(\text{aq})$ (insoluble in excess dilute strong acid)
sulphite, $\text{SO}_3^{2-}(\text{aq})$	SO_2 liberated with dilute acids; gives white ppt. with $\text{Ba}^{2+}(\text{aq})$ (soluble in excess dilute strong acid)

3 Tests for gases

<i>gas</i>	<i>test and test result</i>
ammonia, NH_3	turns damp red litmus paper blue
carbon dioxide, CO_2	gives a white ppt. with limewater (ppt. dissolves with excess CO_2)
chlorine, Cl_2	bleaches damp litmus paper
hydrogen, H_2	'pops' with a lighted splint
oxygen, O_2	relights a glowing splint
sulphur dioxide, SO_2	turns potassium dichromate(VI) (aq) from orange to green

- 1 When aqueous sodium chloride, NaCl , is added to aqueous lead nitrate, $\text{Pb}(\text{NO}_3)_2$, a white precipitate of lead chloride, PbCl_2 , is produced. A suggested stoichiometric equation is



In separate experiments, different volumes of 0.20 mol dm^{-3} aqueous sodium chloride are added to a fixed volume of 0.10 mol dm^{-3} aqueous lead nitrate. In each case, the precipitate is filtered, washed with distilled water and thoroughly dried. The mass of the precipitate is recorded.

You are to plan an experiment to investigate this reaction in order to confirm or reject the stoichiometry of the equation.

- (a) By considering the suggested stoichiometric equation, predict and explain how the number of moles of the precipitate, PbCl_2 , will change as the number of moles of NaCl added increases.

Prediction

.....

Explanation

.....
 [2]

- (b) State a limiting factor that must be taken into account when increasing the volume of the aqueous sodium chloride added.

.....

Sketch the graph which would result if, after some of the experiments, the NaCl is in excess. Start your graph with no NaCl added.

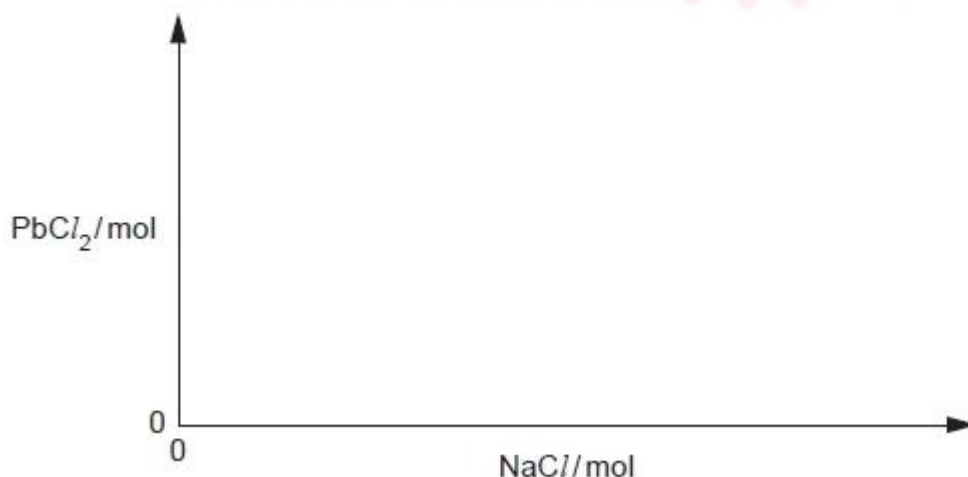

[3]



.....
.....
.....
..... [6]

(e) In the table below

- enter appropriate headings to show additional data you would record when carrying out your experiments and the values you would calculate in order to construct a graph to support or reject your prediction in (a). The headings should include the appropriate units,
- enter the volumes from your plan in (d),
- enter suitable volumes for four further experiments.

[2]

(f) How would you ensure that at the end of each experiment the precipitate was thoroughly dried?

.....
..... [1]

[Total: 16]

- (b) Sodium bromide crystallises as $\text{NaBr} \cdot 2\text{H}_2\text{O}$ at low temperatures and as NaBr at higher temperatures.

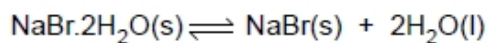

Temperature / °C	10	20	30	40	50	60	70	80	90	100
'Solubility' of sodium bromide /g per 100g H_2O	84.2	90.5	97.2	105.8	116.0	116.9	117.4	118.3	119.8	121.2

Plot the 'solubility' temperature data for sodium bromide and draw one curve for the 'solubility' of $\text{NaBr} \cdot 2\text{H}_2\text{O}$ and another curve for the 'solubility' of NaBr . Estimate the transition temperature from your graph.

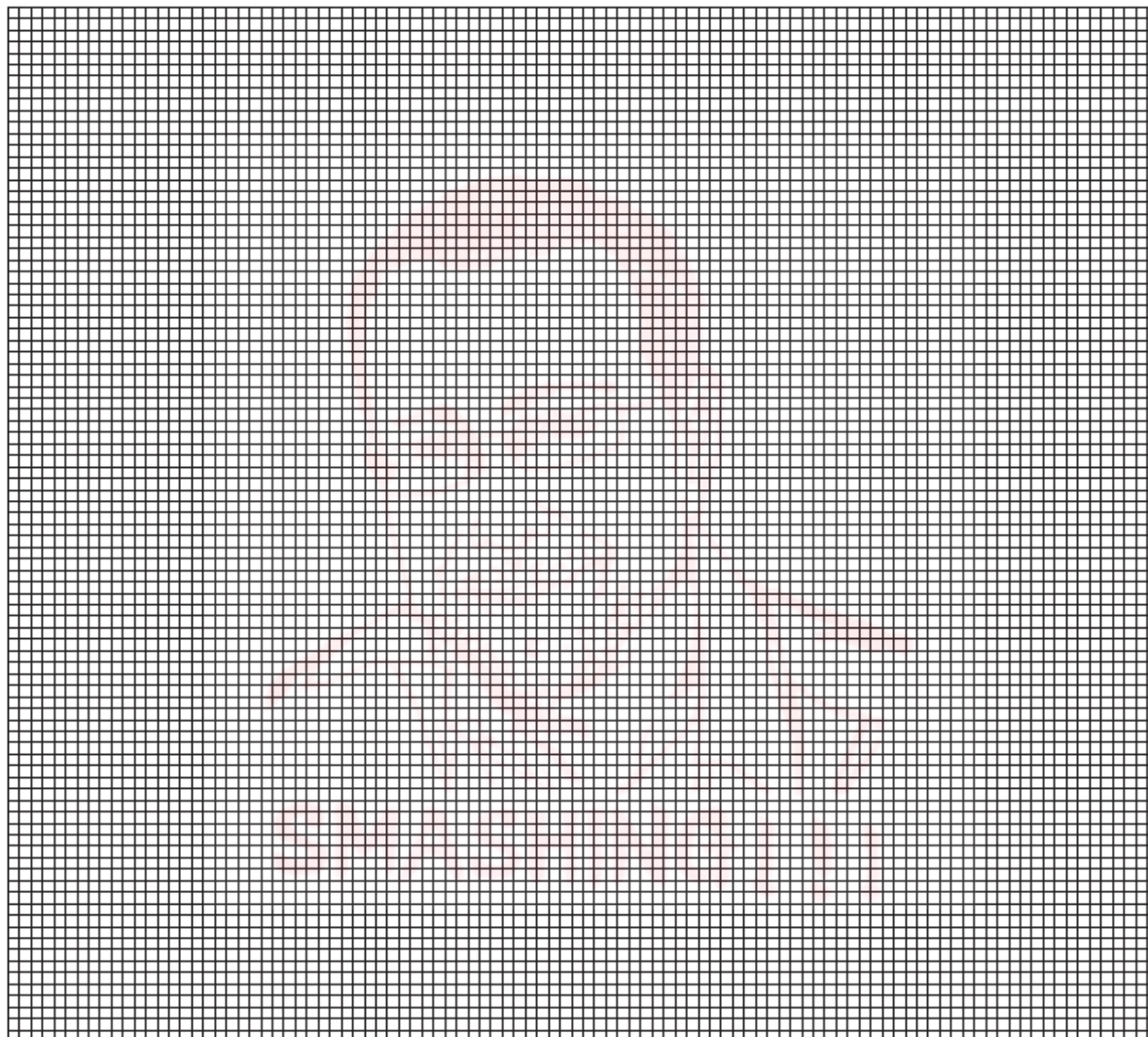

The estimated transition temperature is °C [3]

[Total : 10]

2 A student reads in a text-book about ideal and non-ideal mixtures of liquids.

When two different liquids are mixed, bonds between molecules in each of the different liquids are broken and new bonds are formed between the different molecules in the mixture.

In an ideal mixture the energy used to break bonds between molecules in the different liquids is approximately the same as the energy released when new bonds are formed between molecules in the mixture.

In a non-ideal mixture the energy used to break bonds in the different liquids is **not** the same as that released in bond formation.

The breaking of bonds is an endothermic process.

The formation of bonds is an exothermic process.

In order to test this information, the student investigates a number of mixtures of

- (i) propan-1-ol, $\text{CH}_3\text{CH}_2\text{CH}_2\text{OH}$, and propan-2-ol, $\text{CH}_3\text{CHOHCH}_3$,
- (ii) ethanol, $\text{CH}_3\text{CH}_2\text{OH}$, and cyclohexane, C_6H_{12} .

The boiling point of each pure liquid and each mixture is measured. The thermometer used has graduations at 0.2°C .

The results for the experiment with propan-1-ol and propan-2-ol, which was carried out four times, are shown on the next page.

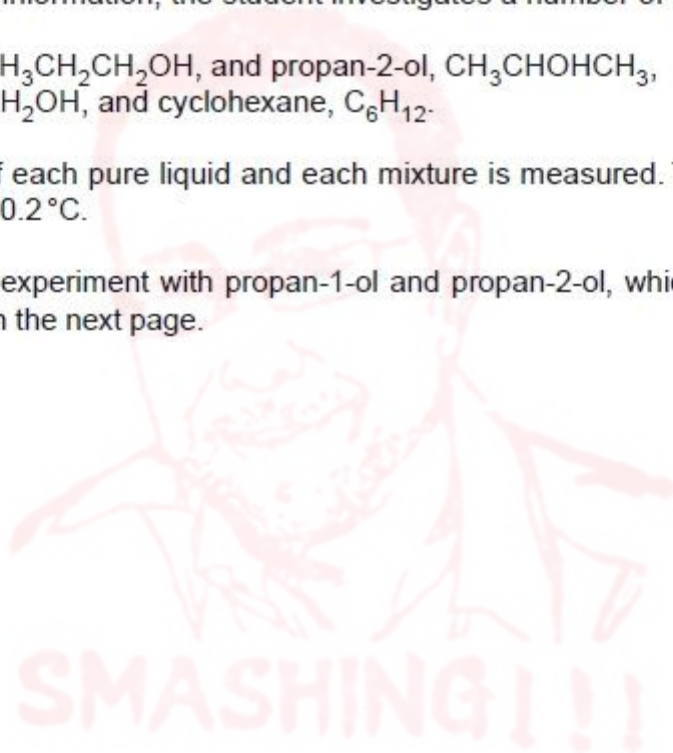

volume / cm ³		temperature of boiling mixture / °C				% (by volume) of propan-1-ol in mixture	mean boiling temperature / °C
propan-1-ol	propan-2-ol	1	2	3	4		
0	20.00	82.1	82.6	82.7	82.2		
4.00	16.00	85.3	85.4	85.5	85.4		
8.00	12.00	88.5	88.4	88.1	88.2		
12.00	8.00	91.3	90.6	91.2	91.4		
16.00	4.00	94.2	94.0	94.3	94.3		
20.00	0	97.1	97.3	97.2	97.8		

(a) Indicate below any results that you consider to be anomalies and that should not be included when calculating the mean boiling temperature.

.....

 [1]

(b) Complete the table above to show the following.

- (i) the percentage (%) by volume of **propan-1-ol** in each of the liquids/mixtures
- (ii) the mean boiling temperature for each of the liquids/mixtures

[2]

The experiment is repeated using mixtures of ethanol and cyclohexane. The results of these experiments are given in the table below.

volume / cm ³		% (by volume) of ethanol in mixture	mean boiling temperature / °C
ethanol	cyclohexane		
0	20.00	0	81.4
2.00	18.00	10.0	66.5
6.00	14.00	30.0	65.0
10.00	10.00	50.0	65.3
14.00	6.00	70.0	65.5
18.00	2.00	90.0	68.0
20.00	0	100.0	78.5

- (c) For both graphs below, use as much of the y-axis as possible for experimental data. Do **not** start your temperature scales at 0 °C. Draw a graph of mean boiling temperature (y-axis) against the % of propan-1-ol (x-axis) in the mixture of propan-1-ol and propan-2-ol.

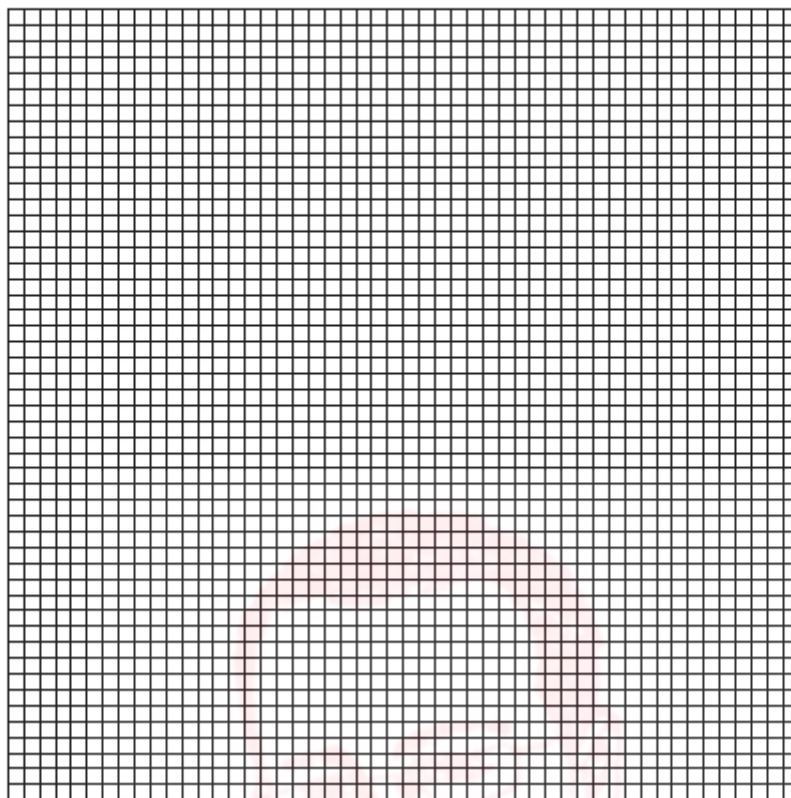

Draw a graph of mean boiling temperature (y-axis) against the % of ethanol (x-axis) in the mixture of ethanol and cyclohexane.

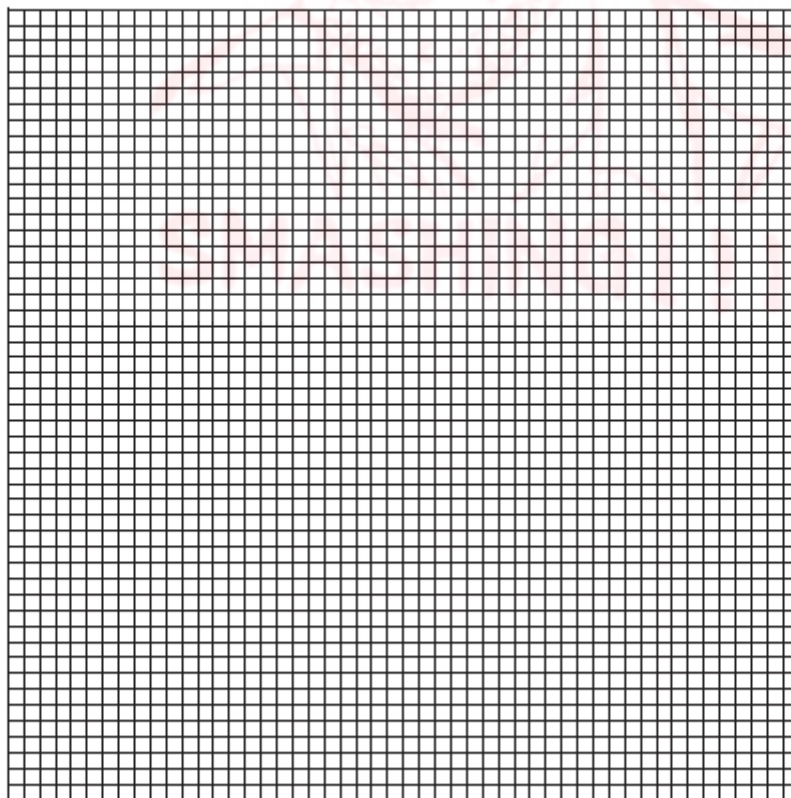

[3]

- (d) The graph you have drawn for propan-1-ol and propan-2-ol is typical of ideal mixtures of liquids.
The graph you have drawn for ethanol and cyclohexane is typical of some non-ideal mixtures of liquids.

From the shape of your graph explain whether the mixing of ethanol and cyclohexane is overall an endothermic or an exothermic process.

The mixing of ethanol and cyclohexane is ,
because

.....

.....

What type of intermolecular forces exist between the molecules of

(i) pure ethanol,

.....

(ii) pure cyclohexane,

.....

(iii) ethanol and cyclohexane in the mixture?
.....

[3]

[Total: 9]

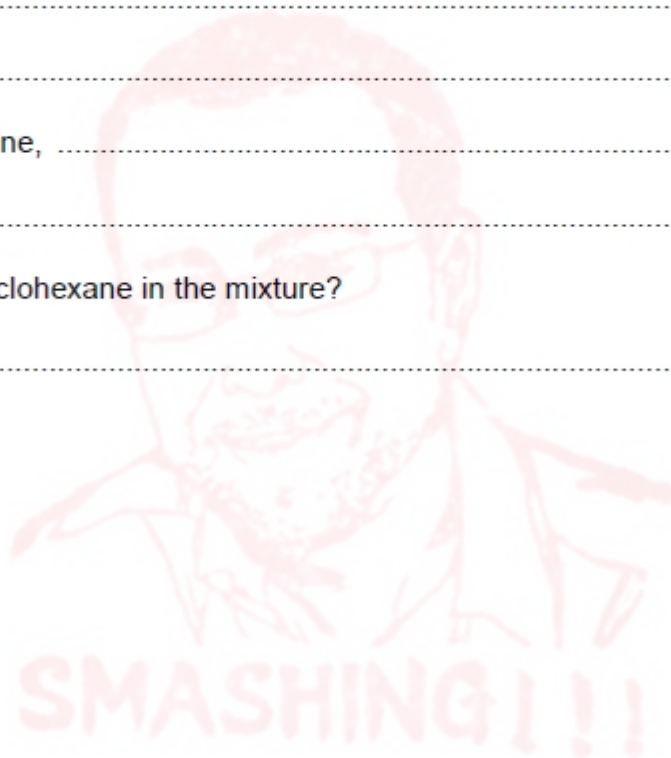

- 1 When a solute is added to a solvent the freezing point of the solution is lower than that of the pure solvent.

The lowering of freezing point is very small. A chemist called Beckmann invented a thermometer capable of measuring these small temperature changes accurately. The Beckmann thermometer must be calibrated at the start of the experiment.

An incomplete diagram of the Beckmann apparatus is shown containing pure liquid cyclohexane, an organic solvent with a freezing point of about 6.5°C . The diagram does not show how the cyclohexane could be frozen.

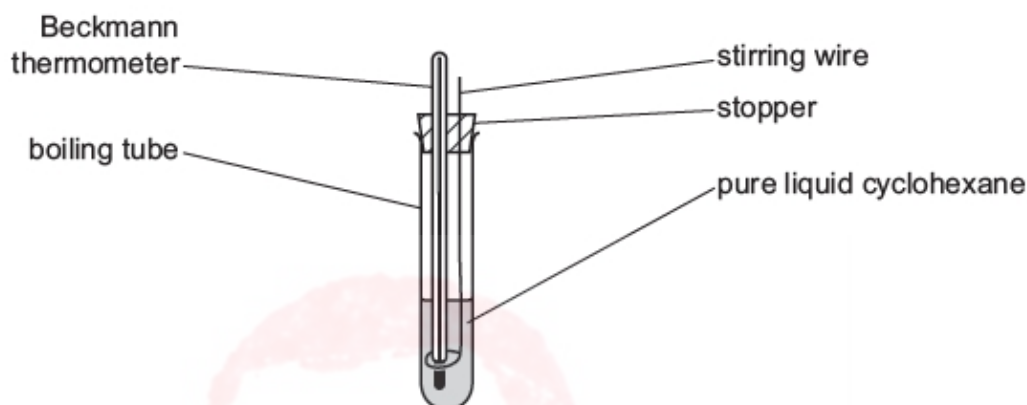

- (a) Complete the diagram to show how the pure liquid cyclohexane could be frozen using simple laboratory apparatus. [1]

(b) The method for determining the lowering of freezing point is as follows.

- step 1** Add 20.00 g of pure liquid cyclohexane to a clean dry boiling tube.
- step 2** Place the stopper containing the Beckmann thermometer and stirring wire into the boiling tube.
- step 3** Cool the pure cyclohexane. When it starts to freeze, set the Beckmann thermometer to 0.00 to calibrate it.
- step 4** Allow the pure cyclohexane to melt. Remove the stopper from the boiling tube. Add 0.250 g of an organic solid **X** to the pure cyclohexane and replace the stopper. Stir the solution to dissolve **X** and refreeze the solution. Record the new freezing point.
- step 5** Allow the solution to melt. Remove the stopper from the boiling tube. Add a further known mass of **X** to the solution and replace the stopper. Stir the solution to dissolve **X** and refreeze the solution. Record the new freezing point.
- step 6** Repeat **step 5** until sufficient readings are obtained.

- (i) In **step 1**, the cyclohexane can be measured using an electronic balance, a beaker and a clean dry boiling tube as shown.

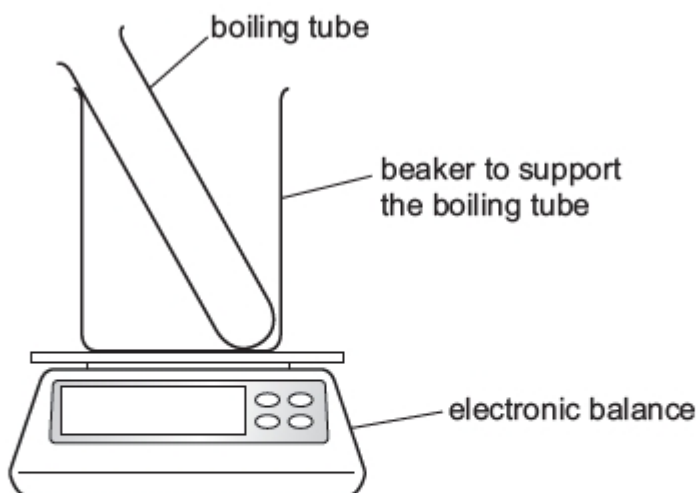

Describe a suitable method to add **precisely** 20.00 g of cyclohexane to the boiling tube. Assume that the balance is accurate to two decimal places and that common laboratory apparatus is available.

.....
..... [1]

- (ii) Alternatively in **step 1**, the volume of cyclohexane with a mass of exactly 20.00 g can be measured and added to the boiling tube.

Calculate the volume of cyclohexane with a mass of precisely 20.00 g. The density of cyclohexane is 0.78 g cm^{-3} . Give your answer to **two** decimal places.

volume of cyclohexane cm^3

Explain whether a burette is suitable for measuring this volume.

.....
.....
..... [2]

- (iii) In **step 4** the mass of **X** is measured on an electronic balance accurate to three decimal places before adding it to the cyclohexane.

A student suggests the following technique.

- An empty container is placed on the electronic balance.
- The mass of the empty container is recorded to three decimal places.
- 0.250 g of **X** is added to the container.
- **X** is tipped from the container into the cyclohexane.

Explain why this technique would **not** be accurate for adding 0.250 g of **X** to the cyclohexane.

.....

.....

..... [1]

- (c) The freezing points of the solutions are lower than the freezing point of pure cyclohexane.

$$\Delta T_{\text{fp}} = (\text{freezing point of pure cyclohexane}) - (\text{freezing point of the solution})$$

For the experiment described in (b) the values of ΔT_{fp} are recorded in the table.

- (i) A ratio, B, is calculated as follows.

$$B = \frac{\text{mass of X (g)}}{\text{mass of solvent (g)}}$$

Complete the table by calculating B for each reading. Give your answers to **three** significant figures.

reading number	total mass of X added to 20.00 g of cyclohexane /g	B	$\Delta T_{\text{fp}} / ^\circ\text{C}$
1	0.250		1.35
2	0.400		2.20
3	0.500		2.75
4	0.800		4.40
5	0.950		5.30
6	1.150		6.40
7	1.300		7.25
8	1.400		8.50

[2]



(ii) Plot a graph on the grid to show the relationship between B and ΔT_{fp} . Draw the line of best fit.

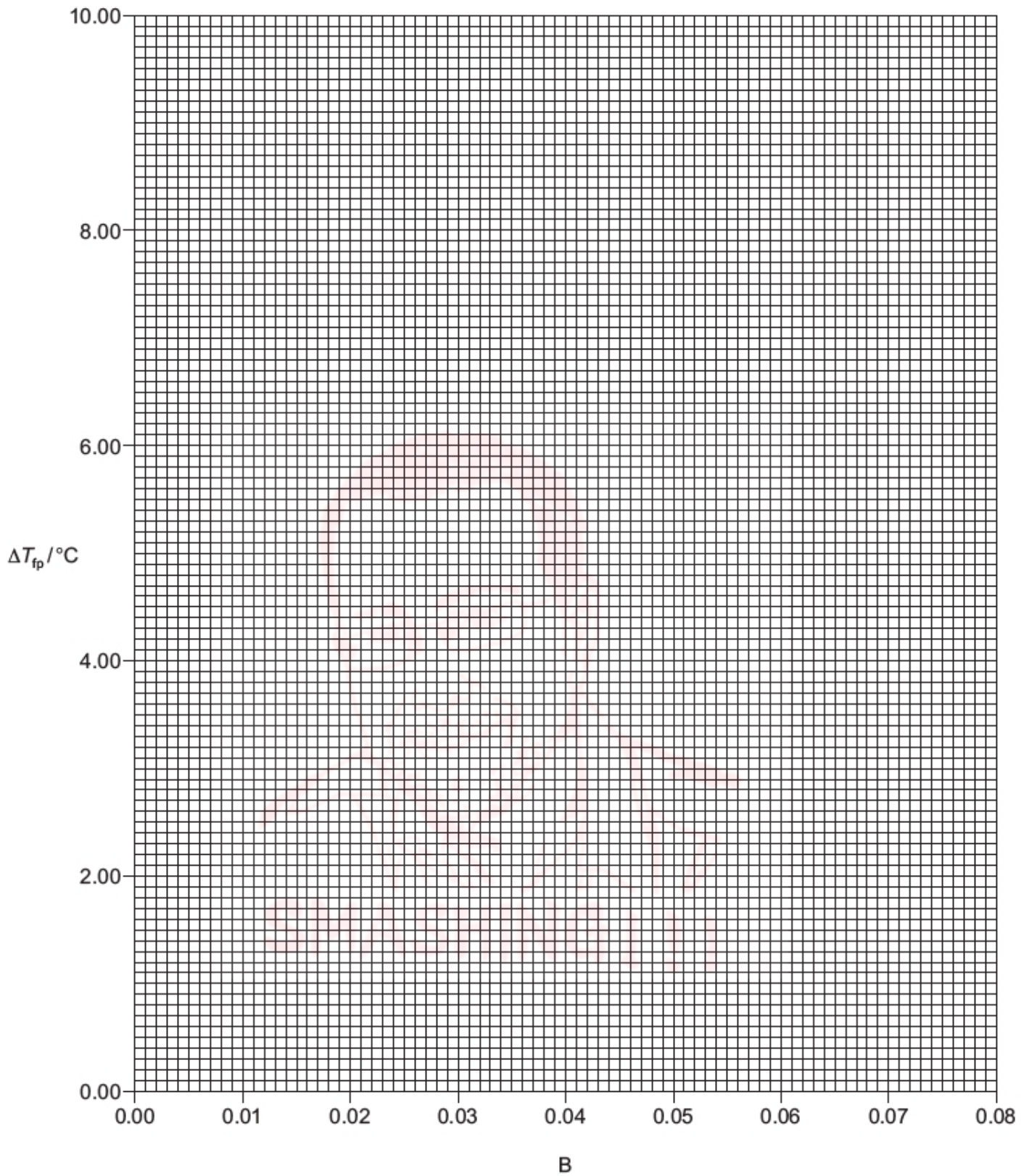

[2]

- (iii) Identify, by the reading number, the single most anomalous point. Suggest what error in the experiment could have caused this anomaly.

reading number

reason

[1]

- (iv) In another experiment, a student added an unknown mass of **X** to 20.00 g of cyclohexane and measured ΔT_{fp} as 5.00 °C.

Use your graph to determine the mass of **X** used in this experiment.

mass of **X** = g [2]

- (v) Determine the gradient of your line of best fit. State the coordinates of the **two** points you used for your calculation.

coordinates 1 coordinates 2

gradient = °C [2]

(d) ΔT_{fp} is related to the M_r of **X** by the following expression

$$\Delta T_{\text{fp}} = \frac{KB}{M_r}$$

where

$$B = \frac{\text{mass of X (g)}}{\text{mass of solvent (g)}}$$

K = a constant

The M_r of **X** can be found using the gradient of your line of best fit.

$$M_r = \frac{K}{\text{gradient}}$$

The numerical value of K is 20 020.

Use this value for K and the gradient you determined in (c)(v) to calculate the M_r of **X**. Give your answer to the nearest whole number.

If you were unable to calculate the gradient in (c)(v), assume that the gradient is 103 °C. This is **not** the correct value.

$$M_r = \dots\dots\dots [1]$$

(e) A student used the Beckmann apparatus and repeated the experiment described in (b) with an unknown solid **Y**. The student found the M_r of **Y** to be 136.

Y is an aromatic carboxylic acid.

Suggest the structure of **Y**.

[A_r : C, 12.0; O, 16.0; H, 1.0]

[1]

[Total: 16]



- 1 A solder is an alloy of metals which is used to join other metal pieces together. A specialist solder that can be used to join together pieces of aluminium is made from a mixture by mass of 65% zinc, 20% aluminium and 15% copper.

You are to plan an experimental procedure to confirm the composition of a powdered sample of this solder, by adding reagents and then extracting from the mixture each of the following in sequence;

- (i) the copper metal,
- (ii) the aluminium as aluminium hydroxide,
- (iii) the zinc as zinc hydroxide.

You are provided with

- a sample of this solder, with approximate mass 4 g,
- 1.00 mol dm⁻³ sulfuric acid,
- 1.00 mol dm⁻³ ammonia.

No other reagents should be used. Standard laboratory equipment is available including a balance, accurate to two decimal places.

- (a) Complete the flowchart below to show the order in which the reagents would be added to the solder to allow you to extract and separate the components as copper metal, (**Step 1**), aluminium hydroxide, (**Step 2**), and zinc hydroxide, (**Step 3**). You are reminded that aqueous ammonia contains both the base OH⁻ and the complex-forming molecule NH₃.

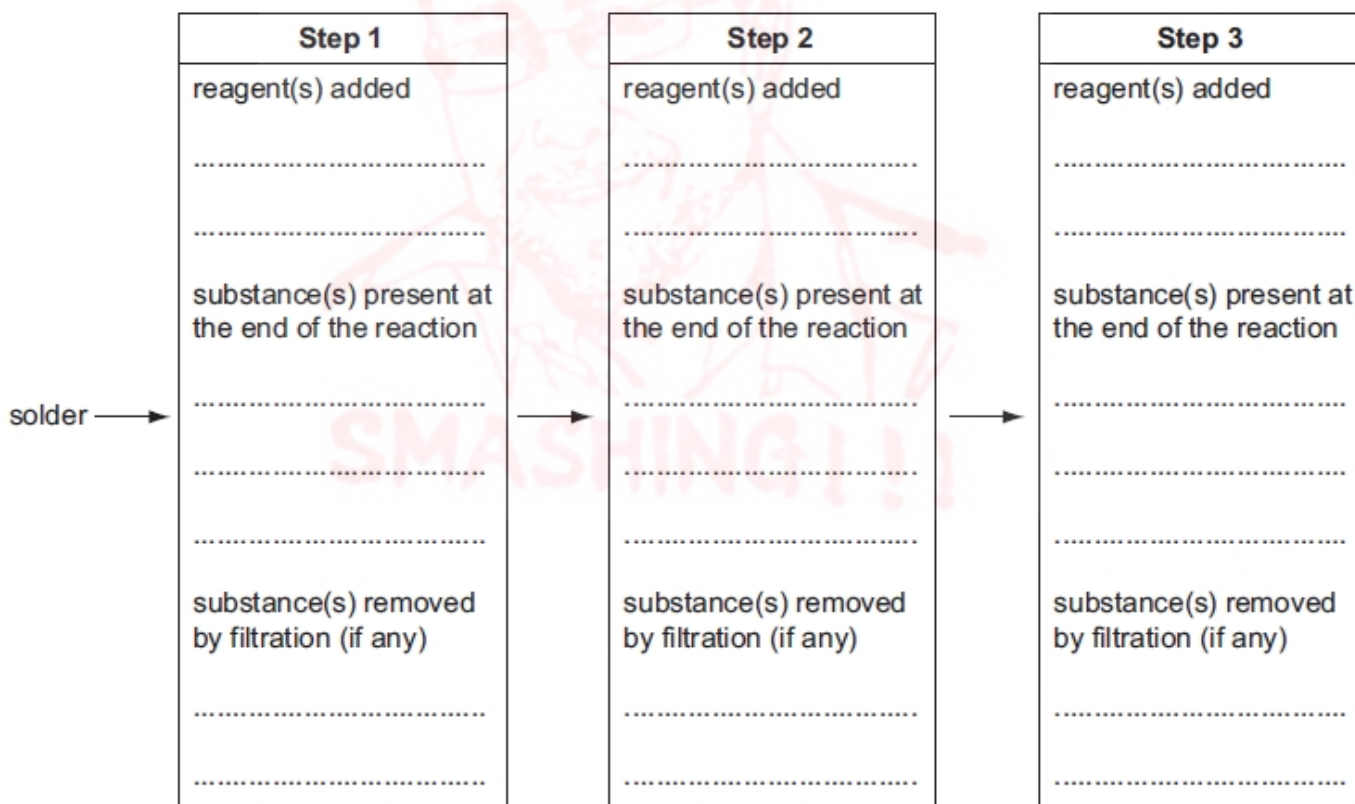

[5]



(b) For some of the steps in the procedure you would need to be careful to add an appropriate quantity of a reagent.

For each step of your procedure explain why particular quantities of reagent should be chosen.

Step 1

.....

.....

Step 2

.....

.....

Step 3

.....

..... [4]

(c) The aluminium hydroxide and zinc hydroxide that have been extracted are difficult to dry so it is better to convert them to their oxides.

Describe how this could be done and how you would make sure that each hydroxide had been completely converted into its oxide.

.....

.....

.....

..... [2]

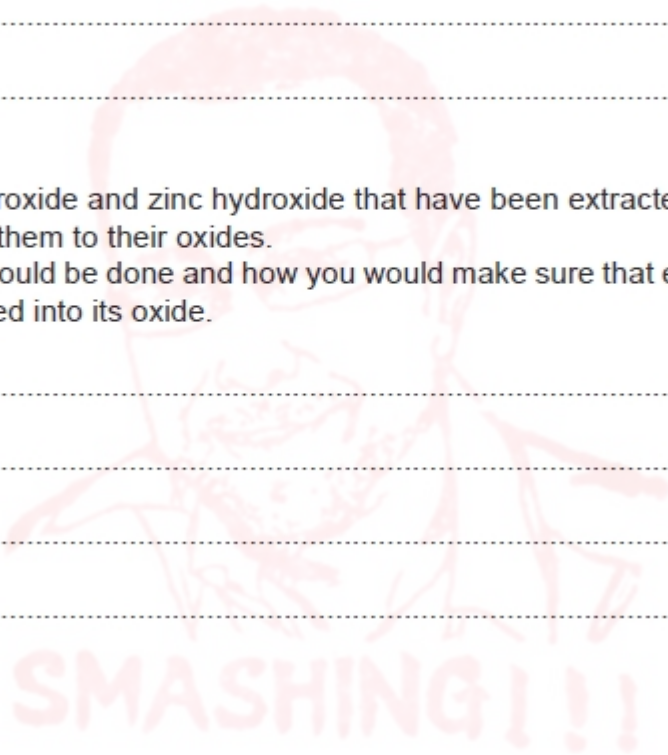

(d) The purpose of the experiment is to confirm the composition of the solder.
When the experiment is carried out state

- the measurements that would be taken,
- what you would do to the copper to make sure that the correct value is obtained.

.....
.....
.....
.....
.....
..... [2]

(e) If the mass of aluminium oxide obtained was 1.50 g, calculate the mass of aluminium that was present in the solder.
(A_r : Al, 27.0; O, 16.0)

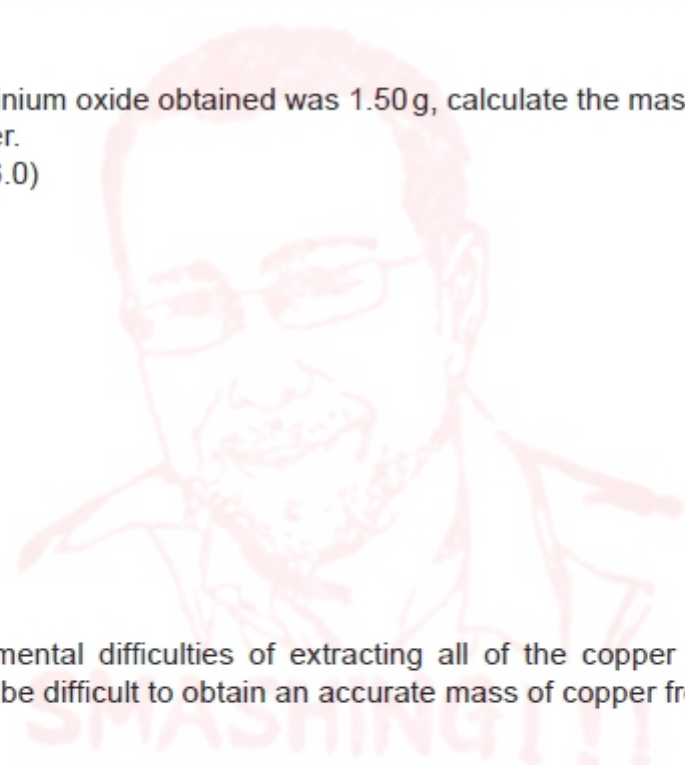

[1]

(f) Even if the experimental difficulties of extracting all of the copper from the mixture were overcome, it would be difficult to obtain an accurate mass of copper from this experiment. Suggest why.

.....
.....
.....
..... [1]

[Total: 15]

- 2** A student was given a sample of an unknown Group 2 chloride. The student dissolved 3.172 g of the unknown Group 2 chloride in distilled water in a beaker and added an excess of aqueous silver nitrate, $\text{AgNO}_3(\text{aq})$, to the beaker.

A white precipitate of silver chloride formed.

- (a)** Write the ionic equation, including state symbols, for the reaction occurring.

..... [1]

- (b)** To separate the filtrate from the residue, filtration can be carried out using gravity or by using reduced pressure.

The student decided to filter the mixture under reduced pressure.

- (i)** Complete the labelled diagram to suggest how the student could filter the mixture under reduced pressure.

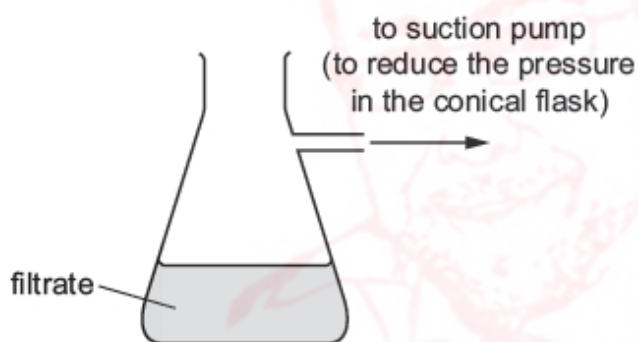

[2]

- (ii)** Suggest **one** major advantage of filtering the mixture under reduced pressure compared with filtering using gravity.

..... [1]

(c) The student rinsed the residue, transferred it to a crucible and placed it in a warm oven to dry it.

(i) What should the student do to ensure that the drying process is complete?

..... [1]

(ii) The student recorded the masses shown in the table.

Complete the table to calculate the mass of dry silver chloride formed. Use this value to determine the number of moles of silver chloride formed.

[A_r: Cl, 35.5; Ag, 107.9]

mass of crucible + dry silver chloride /g	24.898
mass of empty crucible /g	19.162
mass of dry silver chloride /g	

moles of silver chloride formed = mol [1]

(iii) Use your answer to (ii) to calculate the mass of **one** mole of the Group 2 chloride and hence identify the Group 2 metal present in the chloride.

If you were unable to calculate an answer in (ii), assume that 0.0304 mol of silver chloride formed. This is **not** the correct value.

[A_r: Be, 9.0; Mg, 24.3; Ca, 40.1; Sr, 87.6; Ba, 137.3]

mass of **one** mole of the Group 2 chloride = g

identity of the Group 2 metal = [3]

(iv) State and explain how the number of moles of silver chloride formed in (ii) would change if the student used tap water instead of distilled water to dissolve the Group 2 chloride.

.....
..... [1]

[Total: 10]

- 2 A student plans to prepare propanone from propan-2-ol and test the product. Reagents provided to the student and some of their hazards are shown in the table.

reagent	hazard
propan-2-ol	flammable
concentrated sulfuric acid	corrosive
potassium dichromate(VI)	oxidising
distilled water	non-hazardous

- (a) (i) The full equation for the reaction between propan-2-ol and acidified potassium dichromate(VI) is shown.

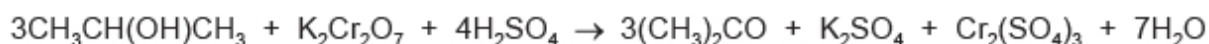

Calculate the minimum mass of potassium dichromate(VI) that is needed for complete oxidation of 5.00 g of propan-2-ol to propanone. Give your answer to **three significant figures**.

[A_r: K, 39.1; Cr, 52.0; O, 16.0; C, 12.0; H, 1.0]

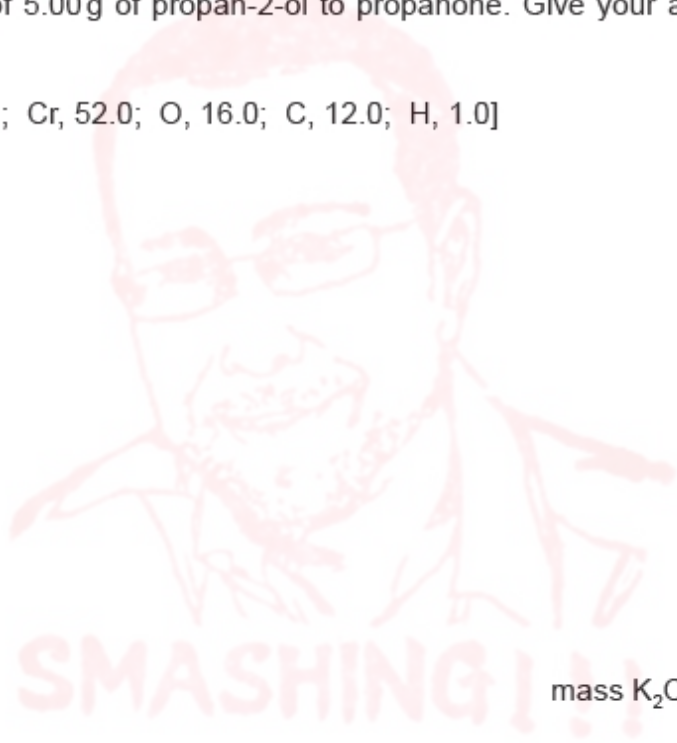

mass $\text{K}_2\text{Cr}_2\text{O}_7 = \dots\dots\dots$ g
[2]

(ii) The student is provided with a set of instructions to prepare the propanone.

- step 1 Add concentrated sulfuric acid to 5.0g of propan-2-ol in a round-bottomed flask, a few drops at a time.
- step 2 Dissolve the mass of potassium dichromate(VI) calculated in (a)(i) in a few cm³ of distilled water.
- step 3 Add this aqueous potassium dichromate(VI) slowly to the mixture in the round-bottomed flask.
- step 4 Heat the mixture under reflux.
- step 5 Separate the propanone from the reaction mixture using distillation.

The student is also provided with the boiling points of propan-2-ol and propanone.

compound	boiling point / °C
propan-2-ol	82.5
propanone	56.5

Complete the diagram to show how the propanone is separated from the reaction mixture in step 5.

Label your diagram fully including the location of propan-2-ol and propanone after distillation has taken place. There is no need to include clamps.

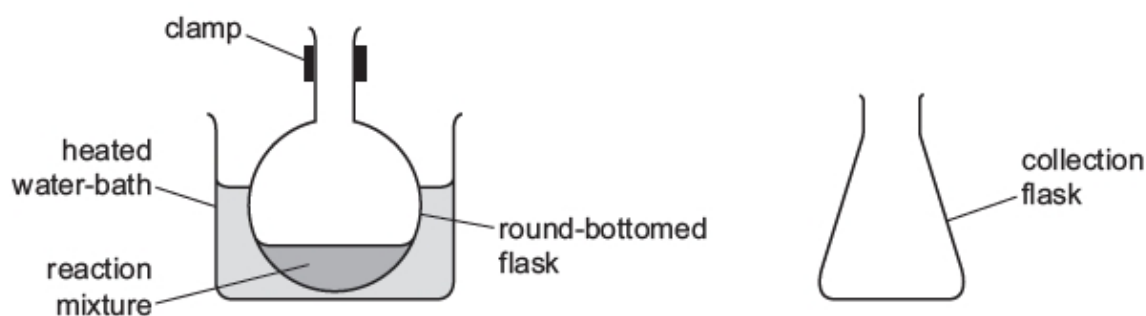

[3]

(iii) The reaction mixture needs heating for reflux to take place.

Explain why a water-bath is used to heat the mixture.

.....
.....
..... [1]

(iv) The propanone separated from the mixture in step 5 contains sulfuric acid as an impurity which needs to be removed.

Name a reagent that could be added to remove the sulfuric acid and explain how the student would ensure that all of the acid is no longer present.

reagent

explanation

..... [2]



- (b) (i) When propanone reacts with a solution of 2,4-DNPH an insoluble compound, **X**, is produced according to the following equation.

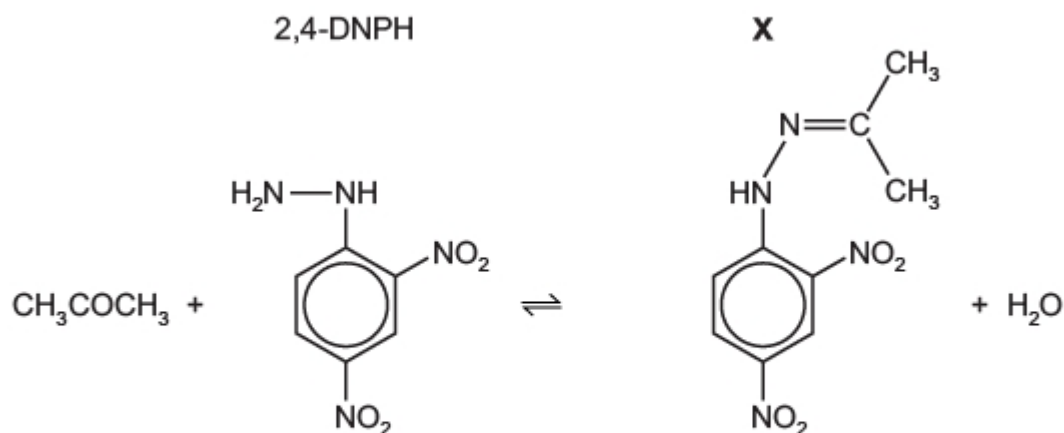

The melting point of **X** can be used to confirm the identity of the carbonyl compound that has reacted with 2,4-DNPH. To do this, solid **X** must be separated from the mixture.

This can be done using method **A** or method **B**.

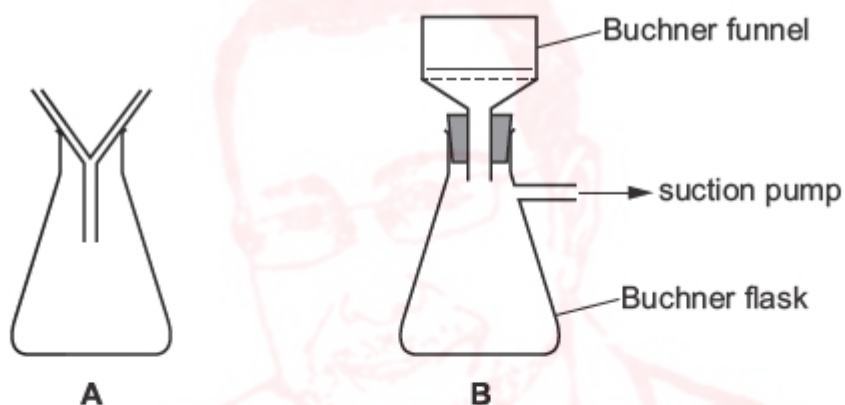

method **A**: gravity filtration using a filter funnel, filter paper and a conical flask

method **B**: filtration under reduced pressure using a Buchner funnel and Buchner flask, filter paper and a suction pump to reduce the pressure in the Buchner flask

Suggest **one** major advantage of using method **B** rather than method **A**.

.....
 [1]

- (ii) The student places a washed sample of **X** in a drying oven for an hour. The student records the mass of **X**. The student wants to ensure that **X** is completely dry.

Describe what the student should do to ensure that **X** is completely dry.

.....
..... [1]

- (iii) 5.00 cm³ of propanone reacts with an excess of 2,4-DNPH. The mass of dry **X** produced is 11.84 g.

Calculate the percentage yield of **X** in this reaction.

$$M_r \text{ X} = 238$$

$$M_r \text{ CH}_3\text{COCH}_3 = 58$$

$$\text{density CH}_3\text{COCH}_3 = 0.789 \text{ g cm}^{-3}$$

percentage yield of **X** = %
[3]

- (iv) Explain why a 100% yield in the preparation of a pure sample of **X** is not possible.

.....
.....
..... [1]

[Total: 14]

- 1 The **solubility** of cerium(IV) sulphate, at a particular temperature, is defined as:
*the mass of cerium(IV) sulphate that will dissolve in and just **saturate** 100 g of solvent at that temperature.*

Cerium(IV) sulphate will dissolve in water.

A **saturated** solution is one in which no more solid can dissolve at a particular temperature.

In a saturated solution in contact with undissolved solid, the following equilibrium is established.

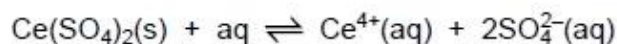

Cerium(IV) sulphate is unusual. Its solubility **decreases** as the temperature of the solution increases.

Cerium(IV) sulphate crystals also dissolve in dilute sulphuric acid, H_2SO_4 , a corrosive aqueous solution.

You are to plan an experiment to investigate how the **solubility** of cerium(IV) sulphate crystals in dilute sulphuric acid depends on the concentration of the acid.

- (a) By considering the ions present in a solution of cerium(IV) sulphate in sulphuric acid predict and explain how the solubility of the cerium(IV) sulphate will be affected by the concentration of the acid.

Prediction

.....

Explanation

.....

.....

Display your prediction in the form of a graph.

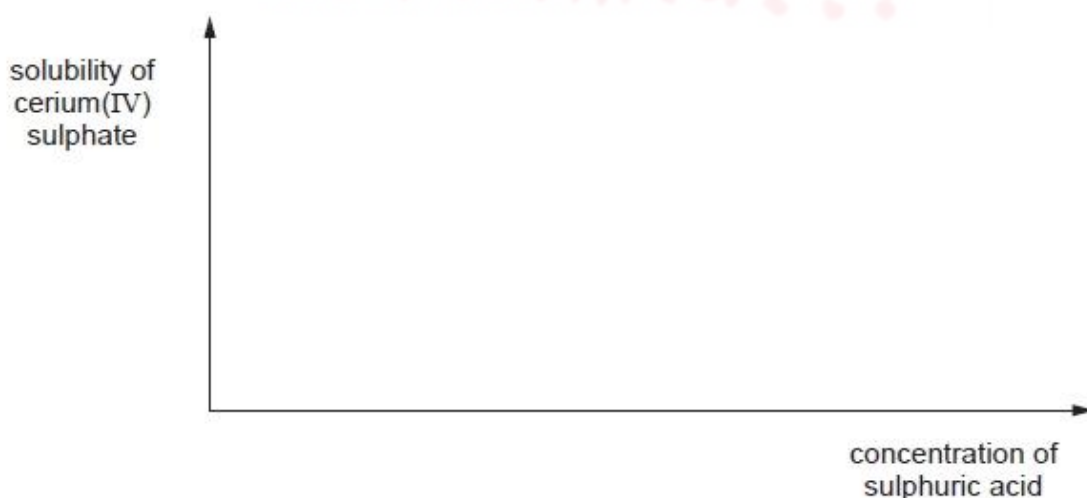

[2]



..... [4]

Part 2 – solubility of cerium(IV) sulphate in sulphuric acid

In addition to the standard apparatus present in a laboratory you are provided with the following materials.

- 5 mol dm⁻³ sulphuric acid
- distilled water
- solid cerium(IV) sulphate

Give a step-by-step description of how you would prepare a range of solutions of sulphuric acid of different concentrations. These solutions could then be used to investigate the solubility of cerium(IV) sulphate in different concentrations of sulphuric acid. See section (e).

Your plan should include details of the following.

- (i) the number and concentrations of the solutions to be prepared
- (ii) the volumes of acid and water used to prepare the solutions
- (iii) the apparatus and method you would use in their preparation



- (e) Draw up a table with appropriate headings to show the data you would record when investigating the solubility of cerium(IV) sulphate in the solutions of sulphuric acid planned in (c), Part 2.



[1]

[Total: 15]

- 2 The melting point of solid water is 0 °C. This is the same as the freezing point of water. This freezing point can be lowered (depressed) by the addition of a solute, such as glucose. The extent of the freezing point depression depends on the **number of particles of solute dissolved** in the solution.

The freezing point depression, ΔT_f , is proportional to the molal concentration, c_m , of the solution.

$$\Delta T_f = K_f c_m$$

where K_f is the freezing point depression constant.

The molal concentration (molality) of a solution is defined as the number of moles of a solute dissolved in one kilogram of water e.g. a one molal solution has one mole of solute dissolved in one kilogram of water.

An experiment was carried out to investigate the relationship between ΔT_f and c_m .

- A weighed sample of distilled water was placed in a boiling tube.
- A weighed sample of glucose was added.
- The mixture was stirred until a solution was obtained.
- The tube was placed in a freezing apparatus to lower the temperature.
- The freezing point of the solution was measured precisely and the freezing point depression calculated.

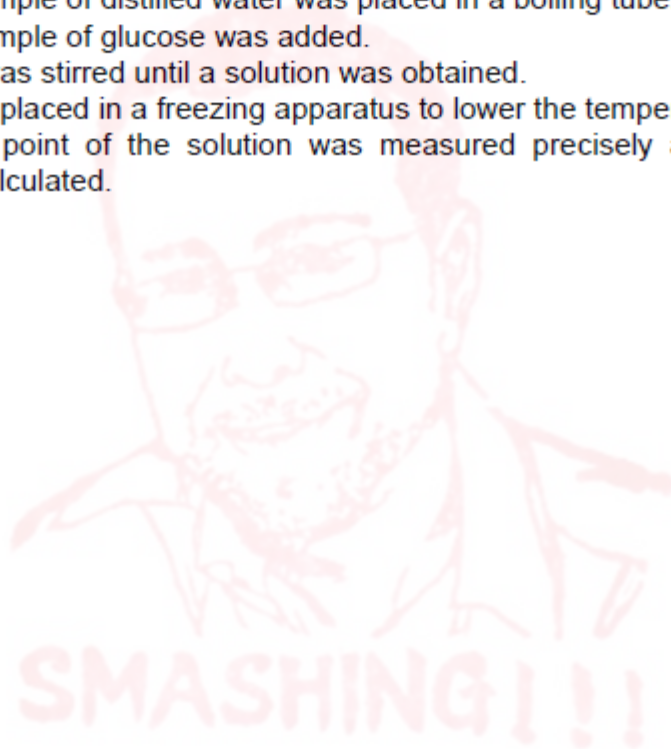

(a) Calculate the M_r of glucose $C_6H_{12}O_6$.

[A_r : H, 1.0; C, 12.0; O, 16.0]

[1]

(b) The results of the experiment are recorded below.

A	B	C	D	E	F
mass of water /g	mass of glucose /g	freezing point depression $\Delta T_f / ^\circ C$			
100	10.0	1.03			
100	12.2	1.26			
100	18.0	2.09			
100	23.3	2.40			
100	27.7	2.86			
100	30.9	3.22			
100	33.1	3.31			
100	38.6	3.98			
100	42.3	4.37			

Process the results in the table to calculate the molality of the glucose solution. This will enable you to plot a graph to show how the freezing point depression, ΔT_f , varies with the molality of the solution.

Record these values to **three significant figures** in the additional columns of the table. You may use some or all of the columns.

Label the columns you use.

For each column you use include units where appropriate and an expression to show how your values are calculated. You may use the column headings A to F for this purpose.

[2]

(c) Present the data calculated in (b) in graphical form. Draw the line of best fit.

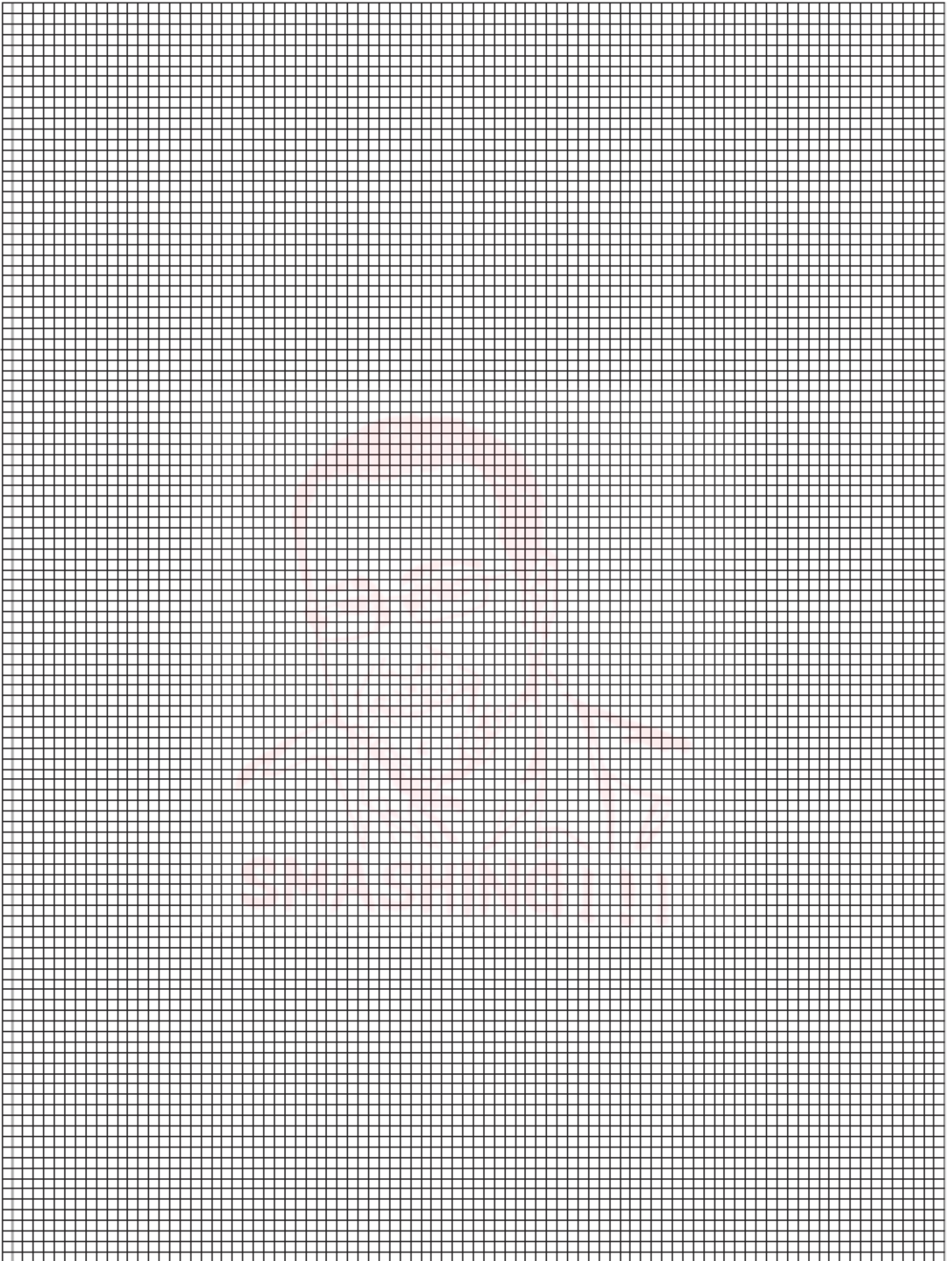

[3]



- (f) When the experiment was repeated using sodium chloride instead of glucose as the solute, the freezing point depressions were found to be twice the value obtained in the glucose experiment for each molality.

Using the information given at the start of the question suggest a reason for this.

.....

.....

..... [1]

- (g) Using your suggestion from (f) predict the effect on the freezing point depression if a weak acid such as ethanoic acid was used instead of glucose or sodium chloride as the solute.

.....

..... [1]

[Total: 14]



2

Solubility is defined as the amount of a substance that will dissolve in and just saturate 100g of solvent at a particular temperature.

$$\text{solubility} = \frac{\text{mass of solid in a saturated solution}}{\text{mass of water in the saturated solution}} \times 100$$

When a solution is saturated, dissolved solid is in equilibrium with undissolved solid.

To make a saturated solution add the solid to water at a particular temperature until no more dissolves. Then add more solid and leave the mixture in a thermostatically controlled water bath to establish equilibrium.

This question uses sodium iodide as the solid to be dissolved and water as the solvent.

When a solution of sodium iodide, NaI, saturated at 100°C is cooled, crystals of NaI form and sink to the bottom of the solution.

As the solution continues to cool a temperature is reached below which crystals of NaI·2H₂O are deposited.

The temperature when this change takes place is called the transition temperature. Above and below this temperature the way in which the **solubility** changes with temperature is noticeably different.

A group of students carried out an experiment to determine the transition temperature.

The instructions given for the experiment were as follows.

- Prepare a saturated solution at a temperature between 20°C and 100°C.
- Record the temperature of the saturated solution.
- Weigh an empty evaporating basin.
- Transfer some of the saturated solution, but no solid, into the weighed evaporating basin.
- Weigh the evaporating basin and solution.
- Evaporate the water from the solution by placing the evaporating basin on top of a beaker of boiling water.
- When all of the water in the solution has evaporated, cool and reweigh the evaporating basin.
- Repeat the heating, cooling and weighing until a constant mass is obtained.



The results of the experiment are recorded below.

A	B	C	D	E	F	G	H
temperature at which the saturated solution was prepared / °C	mass of evaporating basin / g	mass of basin + solution / g	final constant mass of basin + solid / g				
20	23.7	145.1	101.6				
30	31.8	182.0	130.2				
40	33.4	172.5	126.9				
45	25.9	214.3	154.3				
50	31.9	229.1	166.7				
55	27.6	217.0	160.8				
60	33.3	242.9	184.2				
65	31.6	298.7	228.6				
70	28.5	225.7	175.4				
75	29.1	203.6	159.2				
80	30.0	220.4	172.2				
85	27.8	242.4	188.2				
90	36.6	226.0	178.4				
95	31.4	247.0	193.1				
100	32.9	225.9	177.9				

- (a) Process the results in the table to produce values that will enable you to plot a graph to show the **solubility** of sodium iodide in water at different temperatures.

Record these values in the additional columns of the table. You may use some or all of the columns.

Label the columns you use.

For each column you use include the units and an expression to show how your values are calculated.

You may use the column headings A to H in the expressions e.g. C – B. [3]

- (b) Present the values calculated in (a) in graphical form.
Draw **two** separate lines and extrapolate them to a point of intersection. The line at higher temperatures represents the **solubility** of NaI. The line at lower temperatures represents the **solubility** of NaI·2H₂O.
Do **not** start either scale at zero.

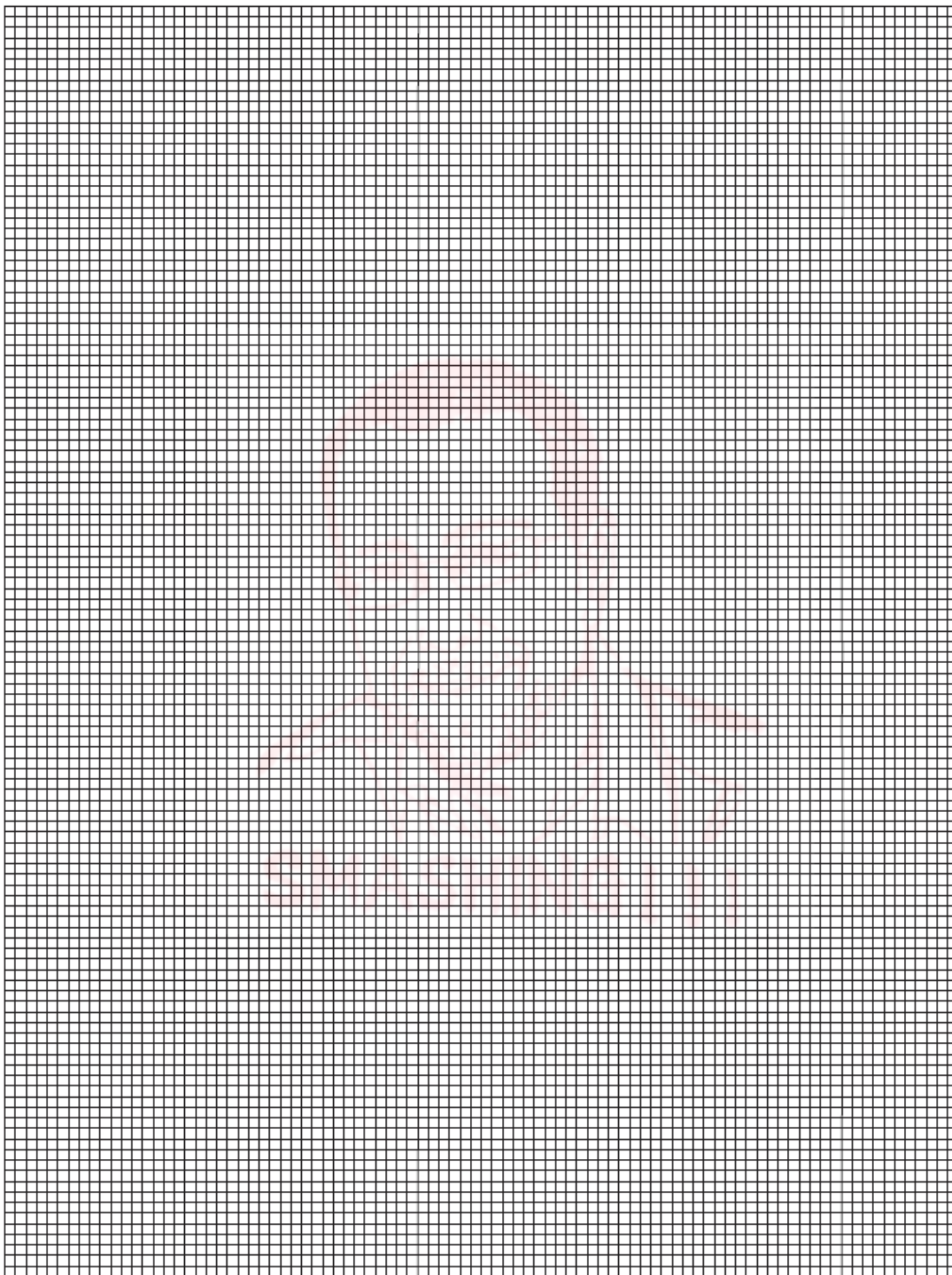

[4]

(f) Describe the difference in the variation of **solubility** with temperature

above the transition temperature,

.....
.....

below the transition temperature.

.....
.....

The **solubility** curve represents equilibrium conditions between solid sodium iodide and dissolved sodium iodide.

The position of equilibrium can be influenced by temperature change and whether a change is exothermic or endothermic.

From the shape of your graph, comment on the likely enthalpy change for solid sodium iodide dissolving under equilibrium conditions. Explain your answer.

.....
.....
.....
.....
.....

[2]

[Total: 15]

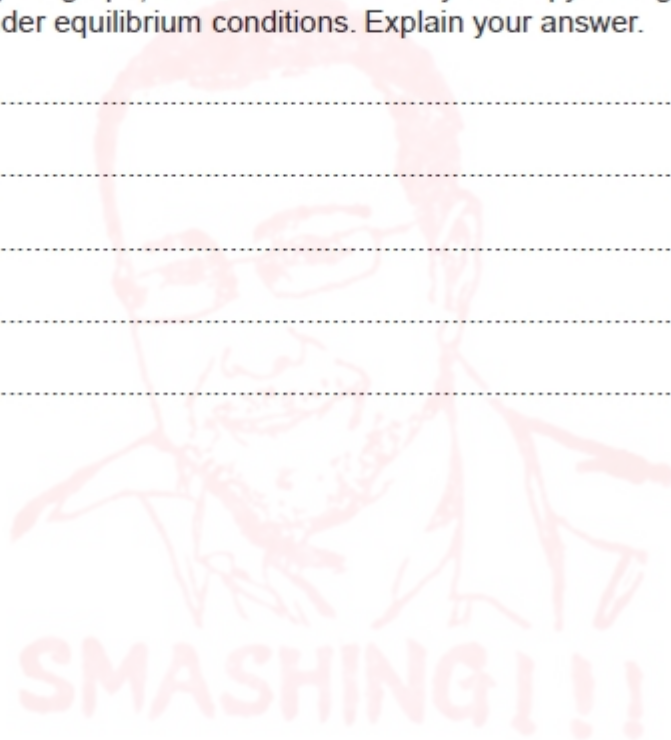

- 2 The solubility of hydrated sodium sulfate, $\text{Na}_2\text{SO}_4 \cdot 10\text{H}_2\text{O}$, in water increases with temperature. At a temperature between 25°C and 70°C there is a transition and the solubility becomes that of Na_2SO_4 . The units of solubility are grams per one hundred grams of water, g/100 g water.

An experiment was carried out to investigate this solubility and determine the transition temperature between the two forms of sodium sulfate.

- An empty boiling tube was weighed and the mass recorded.
- Some distilled water was added to the boiling tube and the new mass recorded.
- A small sample of hydrated sodium sulfate was added and this new mass recorded.
- The boiling tube was carefully heated with stirring until all the solid had dissolved.
- The apparatus was cooled slowly while constantly stirring and the temperature recorded when the first crystals appeared in the tube.

- (a) The results of several of these experiments are recorded below.

Process the results in the table to calculate the solubility, in g/100 g water, of the sodium sulfate for each of the temperatures listed.

Record these values to **two decimal places** in the additional columns of the table. You may use some or all of the columns.

Label the columns you use.

For each column you use include units where appropriate and an expression to show how your values are calculated.

Use the column headings A to H for these expressions (e.g. A–B).

A	B	C	D	E	F	G	H
experiment number	mass of boiling tube /g	mass of boiling tube + water /g	mass of boiling tube + water + solid /g	crystallising temperature °C			
1	10.20	35.20	36.45	0.0			
2	10.35	30.35	31.60	10.0			
3	10.10	35.10	40.10	20.0			
4	9.80	29.20	36.96	30.0			
5	9.95	32.95	44.06	40.0			
6	9.90	34.90	46.65	50.0			
7	9.70	30.70	40.32	60.0			
8	10.45	30.45	39.55	70.0			
9	10.05	35.05	46.30	80.0			
10	10.10	40.10	53.45	90.0			

[3]

- (b) Plot a graph to show the variation of solubility (y -axis) with temperature (x -axis). Draw **two curves** of best fit and extrapolate to locate their intersection at the transition temperature.

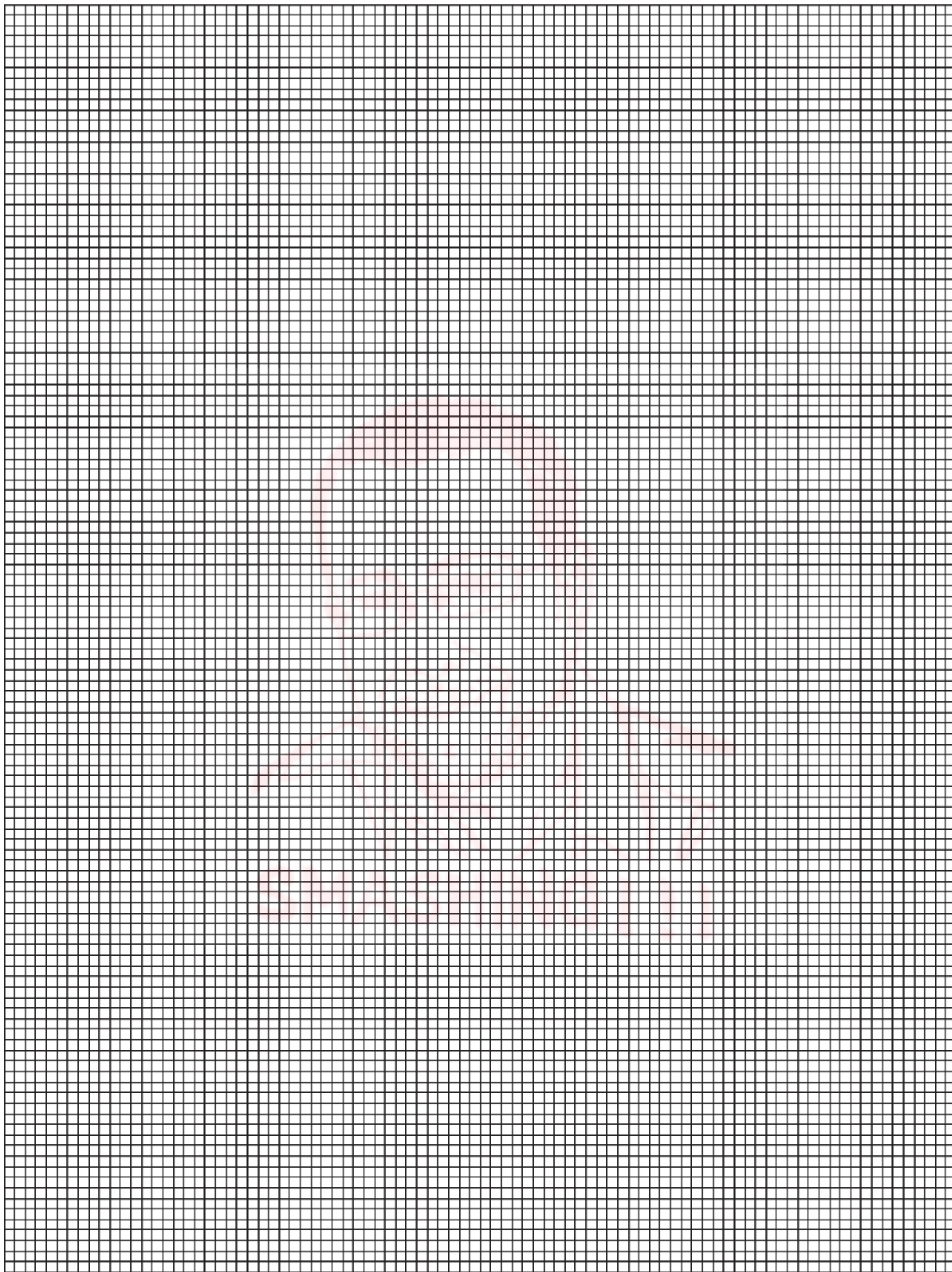

[4]

(c) From your graph, state the transition temperature and the solubility at which it occurs.

[2]

(d) (i) In an attempt to repeat the 4th experiment using the same masses of water and solid, the temperature was mistakenly read and recorded before crystals appeared. Place a cross on your graph to represent the point that would have been obtained.

(ii) If this was a valid point, what effect would this have on your transition temperature? Explain your answer.

.....

.....

.....

[2]

(e) It was found that all the mass recordings in columns C and D had been made with a balance that had been zeroed incorrectly and they should all have been 0.3g smaller. The masses recorded in column B can be considered to be accurate. Using the corrected masses from experiment 6 calculate the new value of the solubility. By comparing this with the original solubility value for experiment 6 calculate the percentage error difference.

[2]



- (f) From the pattern of solubility demonstrated by your graph, predict and explain whether the dissolving of the two forms of sodium sulfate in water are exothermic or endothermic reactions.

prediction for $\text{Na}_2\text{SO}_4 \cdot 10\text{H}_2\text{O}$

.....

explanation

.....

.....

prediction for Na_2SO_4

.....

explanation

.....

.....

.....

[2]

[Total: 15]

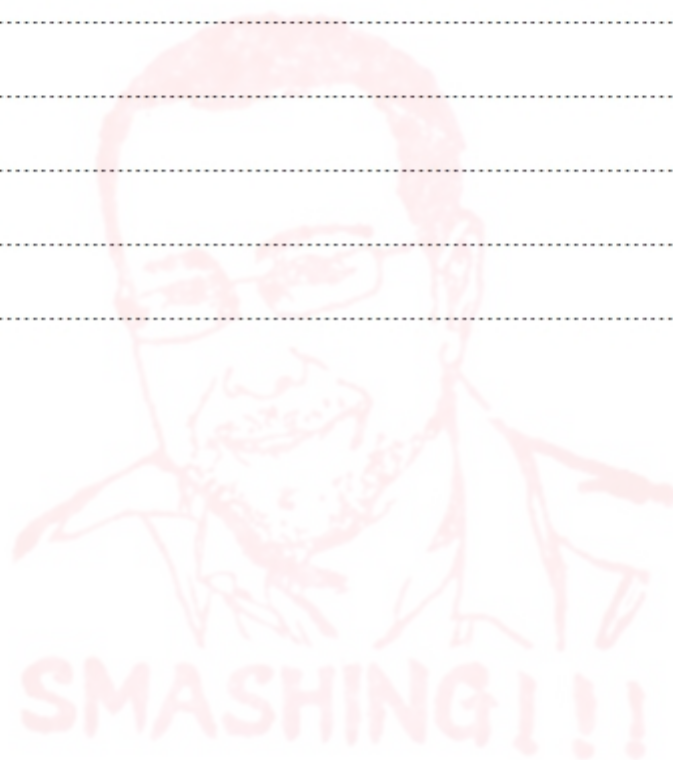

- 1 When an excess of aqueous sodium hydroxide, NaOH, is added to 100 cm³ of aqueous copper(II) sulfate, CuSO₄, a precipitate of copper(II) hydroxide, Cu(OH)₂, is produced.

The stoichiometric equation for this reaction is,

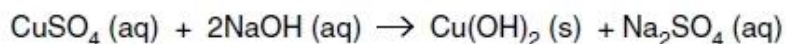

The following information gives some of the hazards associated with these reactants.

Copper(II) sulfate (solid hydrated copper(II) sulfate CuSO₄.5H₂O)

Harmful. Dangerous for the environment.

Harmful if swallowed. Irritating to eyes and skin.

Solutions of concentrations equal to or greater than 1 mol dm⁻³ should be labelled HARMFUL.

Sodium hydroxide (solid NaOH)

Corrosive. Solutions of concentrations equal to or greater than 0.5 mol dm⁻³ are CORROSIVE.

Solutions of concentrations equal to or greater than 0.05 mol dm⁻³ but less than 0.5 mol dm⁻³ are IRRITANT.

You are to plan an experiment to investigate the molar ratio of the equation above and confirm that it remains unchanged as the concentration of the copper(II) sulfate changes.

- (a) (i) Predict quantitatively how the number of moles of the precipitated copper(II) hydroxide varies as the molar concentration of the copper(II) sulfate increases until saturation is reached.

.....

.....

.....

- (ii) Display your prediction in the form of a sketch graph. Remember that you are using 100 cm³ of aqueous copper(II) sulfate. Label clearly the point representing the saturated solution of copper(II) sulfate. A saturated solution at 25°C has a concentration of 1.39 mol dm⁻³. Give appropriate numerical scales to the two axes.



[3]

- (b) In the experiment you are about to plan, identify the following.
- (i) the independent variable
 - (ii) the dependent variable
 - (iii) one other variable to be controlled [2]

(c) Design a laboratory experiment to investigate your prediction in (a).

In addition to the standard apparatus present in a laboratory you are provided with the following materials.

aqueous sodium hydroxide, NaOH (2.0 mol dm^{-3})
solid hydrated copper(II) sulfate, $\text{CuSO}_4 \cdot 5\text{H}_2\text{O}$

Give a step-by-step description of how you would

- (i) prepare enough solutions of copper(II) sulfate of an appropriate range of concentrations to give sufficient data to plot a graph as in (a)(ii),
- (ii) collect and dry the precipitated copper(II) hydroxide,
- (iii) calculate the molar concentration of one of the solutions of copper(II) sulfate.
[A_r : H, 1.0; O, 16.0; S, 32.1; Cu, 63.5]

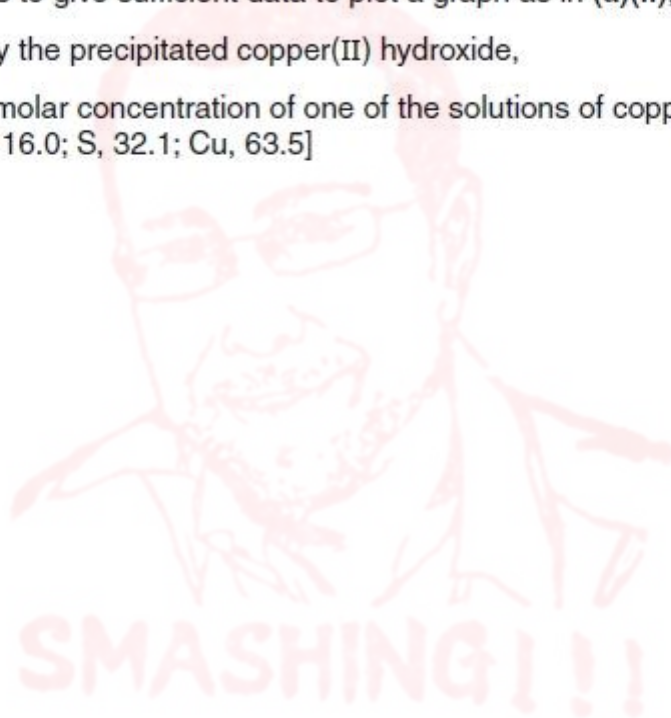

(d) (i) State two hazards that must be considered when planning the experiment.

.....
.....
.....

(ii) State a precaution that should be taken to minimise the risk of one of these hazards.

.....
.....
.....[3]

(e) Draw up a table with appropriate headings to show the data you would record when carrying out your experiments and the values you would calculate in order to construct a graph to support or reject your prediction in (a). The headings should include the appropriate units.



[2]

[Total: 15]



Electrolysis

Topic Chem 24 [Electrolysis_Q# 68/](http://www.SmashingScience.org) ALVl Chemistry/2008/w/TZ 1/ Paper 5/Q# 2/www.SmashingScience.org

- 2 A student reads about the electrolysis of aqueous copper(II) sulphate and makes the following notes.

- reaction at the cathode $\text{Cu}^{2+}(\text{aq}) + 2\text{e}^{-} \rightarrow \text{Cu}(\text{s})$
- reaction at the anode $\text{Cu}(\text{s}) \rightarrow \text{Cu}^{2+}(\text{aq}) + 2\text{e}^{-}$
- 1 mol of $\text{Cu}(\text{s})$ is deposited on the cathode by 2 mol of electrons.
- The Faraday constant is the charge in coulombs, C, on 1 mol of electrons.
- The Faraday constant = $9.5 \times 10^4 \text{ C mol}^{-1}$.

The student realises that a value for the Faraday constant can be determined experimentally using the following apparatus.

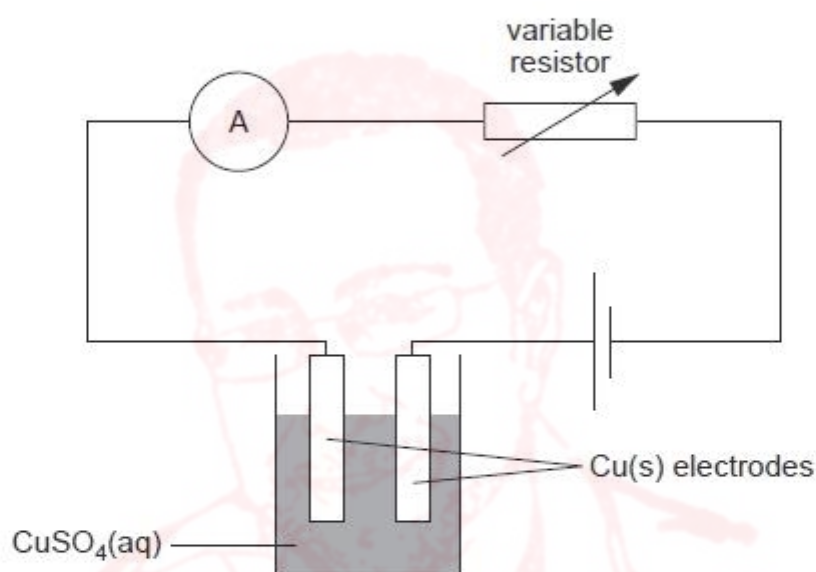

Method

- The cathode is cleaned and weighed before being placed in the copper(II) sulphate solution.
- The circuit is completed and the current set at 0.3 A by adjusting the variable resistor.
- The current is maintained at 0.3 A for exactly 40 minutes at which point the circuit is broken.
- The cathode is removed from the solution and carefully washed with distilled water to remove any copper(II) sulphate solution.
- Distilled water is removed from the cathode by rinsing it with propanone in which the water dissolves.
- The cathode is finally dried by allowing the propanone to evaporate from its surface.
- The cathode is reweighed and placed back in the solution.
- A constant current of 0.3 A is passed for a further 40 minutes when the rinsing, drying and weighing are repeated.
- This procedure is repeated a further 8 times.

The results of the experiment are recorded below.

A	B	C	D	E	F
time /minutes	mass of cathode /g				
0	115.74				
40	115.97				
80	116.22				
120	116.46				
160	116.70				
200	116.94				
240	117.19				
280	117.49				
320	117.67				
360	117.92				
400	118.14				

- (a) Use the additional columns of the table to record the charge passed and the mass of copper deposited on the cathode.

[charge in coulombs = time in seconds \times current in amps; 1 minute = 60 seconds]

You may use some or all of the columns. Label the columns you use, including the units and an equation to show how the value is calculated. [2]

(b) Present the data calculated in (a) in graphical form. Draw the line of best-fit.

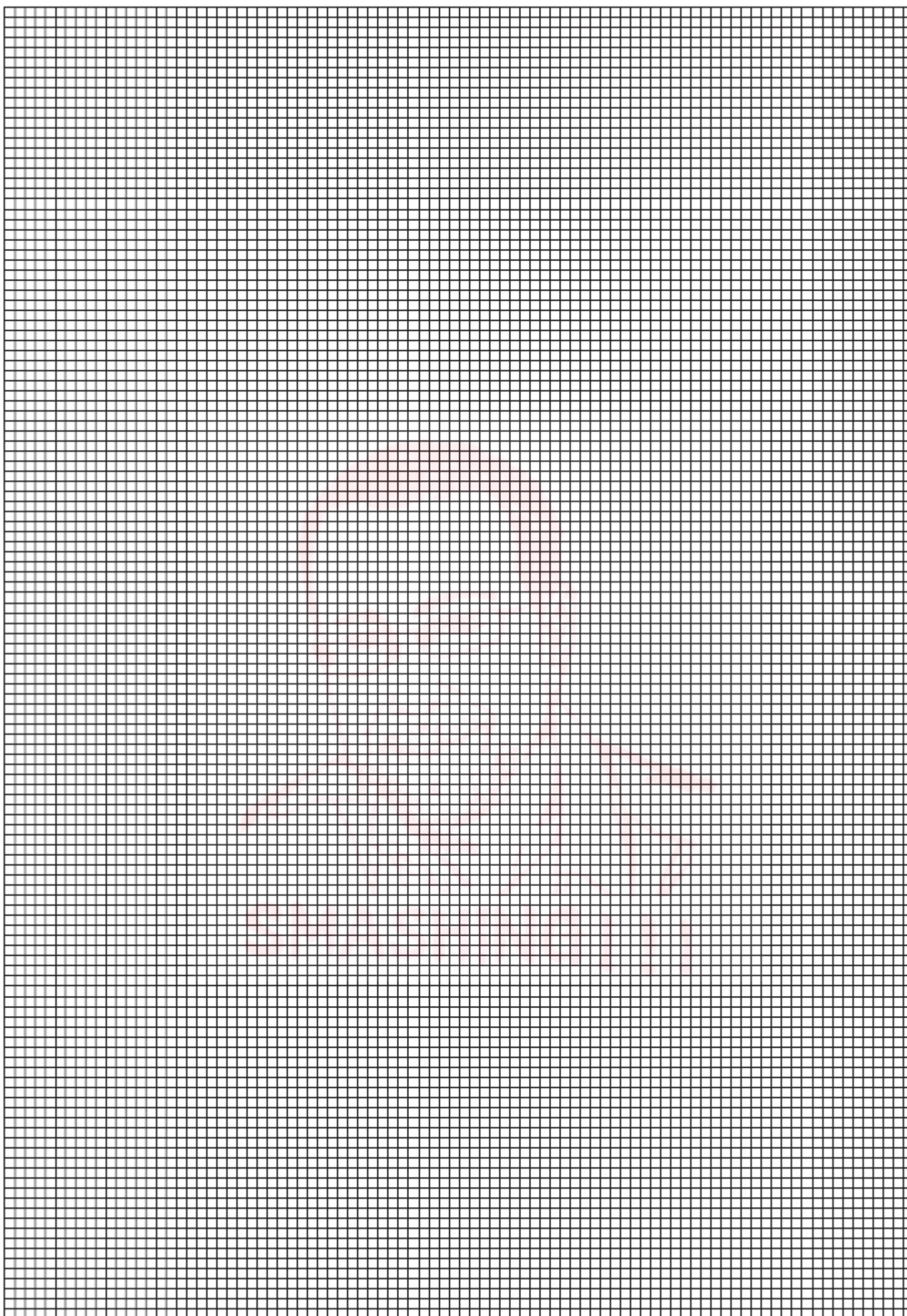

[4]



- (c) Indicate clearly one anomalous point on the graph that you did not use when drawing the line of best-fit. By reference to the instructions for the experiment suggest an explanation for the anomaly.

.....
.....
.....
.....
..... [2]

- (d) The balance used by the student weighed to 2 decimal places. By reference to the results of the experiment explain why it would have been more appropriate to use an analytical balance weighing to 4 decimal places.

.....
.....
.....
..... [1]

- (e) Draw construction lines on the graph to derive relevant values and use them to calculate a numerical value for the Faraday constant.

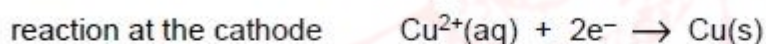

[A_r : Cu; 63.5]

The value of the Faraday constant determined in this experiment is

..... C mol⁻¹. [2]



- (f) By considering the data you have processed and the graph you have drawn, decide if the experimental procedure described is suitable for the determination of the Faraday constant. Explain your reasoning.

.....
.....
.....
.....
..... [2]

- (g) What other measurements could be made during the course of the experiment to provide alternative data to confirm the determined value of the Faraday constant?

.....
..... [1]

- (h) Another student, performing the same experiment, plotted the mass of copper deposited against time, and obtained the results below.

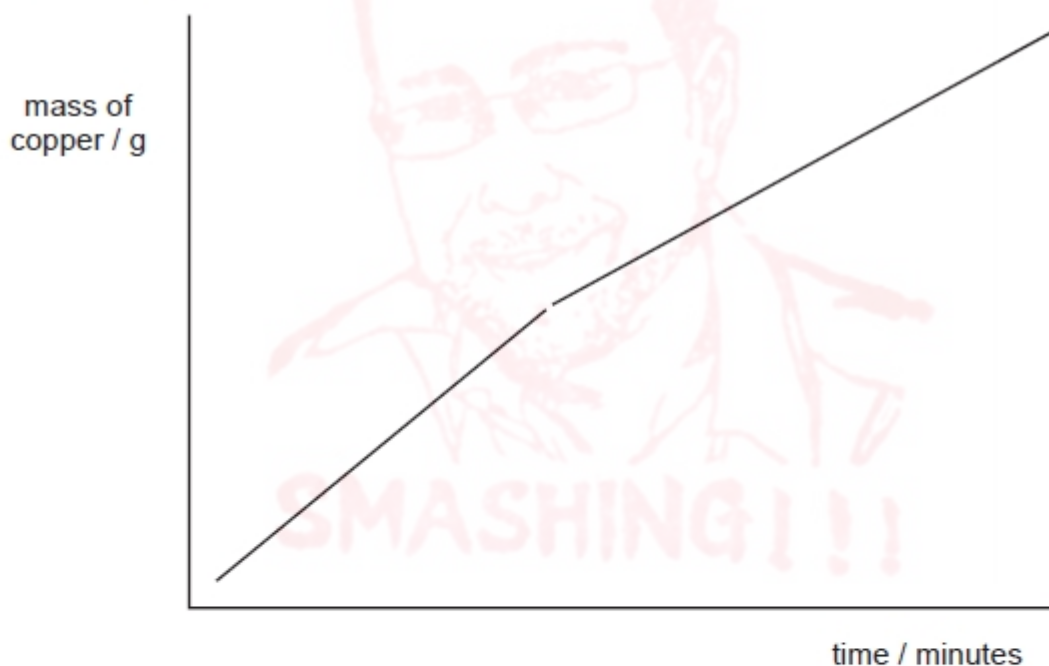

Making reference to the experimental method, suggest an explanation for the shape of this graph.

.....
..... [1]

[Total: 15]



2 An experiment was set up to investigate how the cell potential of a cell containing a metal, M, in contact with an aqueous solution of its ions, $M^{n+}(aq)$ (where $n = 1, 2$ or 3), changed as $M^{n+}(aq)$ was diluted.

Since a standard hydrogen half-cell was not available, a standard half-cell consisting of silver in contact with a 1 mol dm^{-3} solution of silver ions was used to connect to the half-cell with M in contact with $M^{n+}(aq)$.

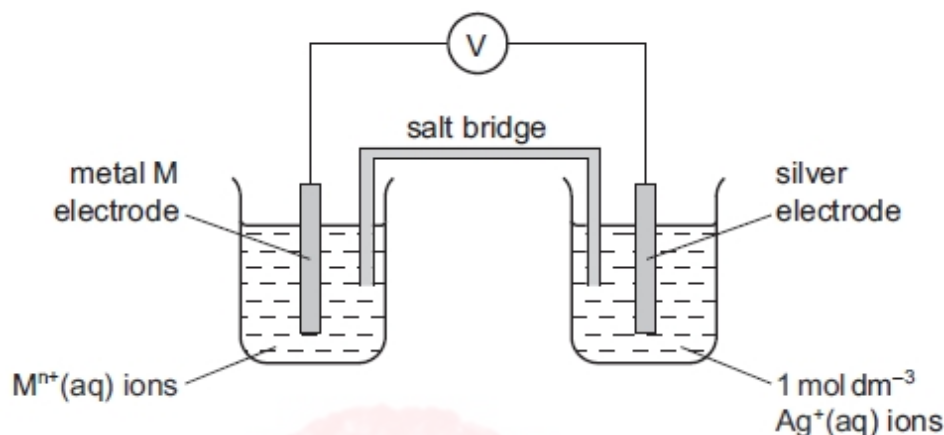

The metal electrodes of the two half-cells were connected via a voltmeter, reading to two decimal places. This was used to measure the cell potential of the cell.

The cell potential was measured for various concentrations of $M^{n+}(aq)$ and the results obtained are shown in the table below.

(a) Complete the third column of the table below. Give each answer to two decimal places.

concentration of $M^{n+}(aq) / \text{mol dm}^{-3}$	cell potential /V	$\log [M^{n+}(aq)]$
5.00×10^{-1}	0.94	
1.00×10^{-1}	0.96	
4.00×10^{-2}	0.97	
1.00×10^{-2}	0.99	
5.00×10^{-3}	1.00	
2.00×10^{-3}	1.01	
8.00×10^{-4}	1.02	
2.00×10^{-4}	1.04	

[2]

(b) Plot a graph to show the relationship between $\log [M^{n+}(aq)]$ and the cell potential measured and draw the line of best fit.

cell potential/V

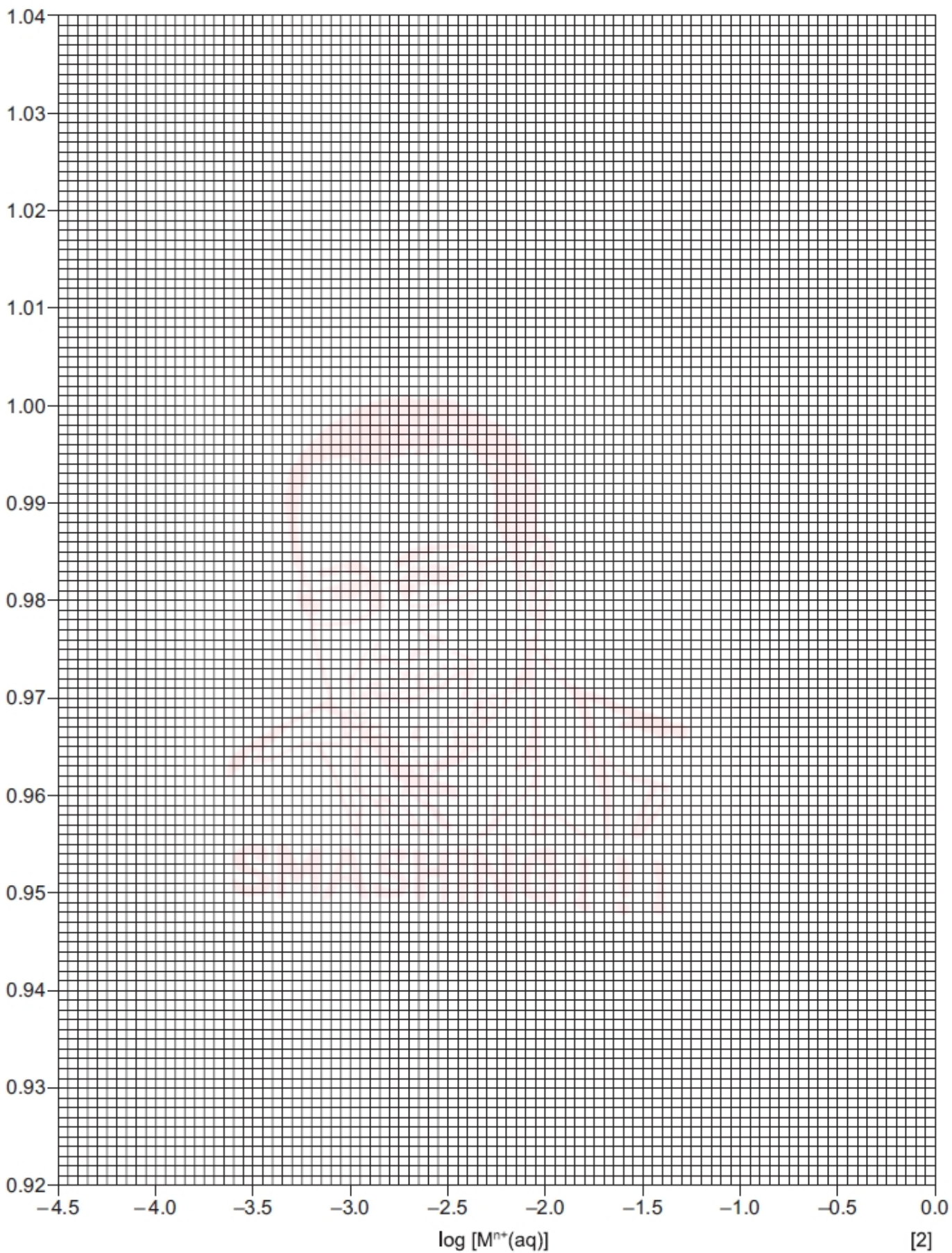

(c) Are there any anomalous points on your graph? If so, circle those points. Give a reason for your answer.

.....
.....
.....
..... [2]

(d) It is known that the cell potential of a cell, E , is related to the standard electrode potential, E^\ominus , by the equation:

$$E = E^\ominus - \frac{0.06 \log [M^{n+}(aq)]}{n}$$

(i) Use your graph to determine the charge, n , of the M^{n+} ions. Draw appropriate lines on your graph to enable you to calculate its slope and show in the space below, how n was calculated.

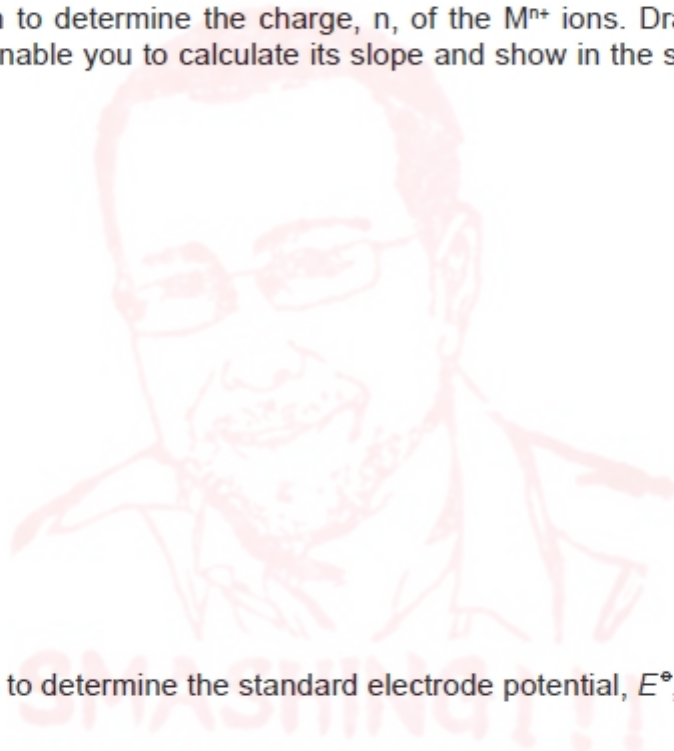

[3]

(ii) Use your graph to determine the standard electrode potential, E^\ominus , of the cell.

.....
..... [1]

(e) The standard electrode potential for silver is +0.80 V.
Calculate the standard electrode potential for the metal, M. Use the data given on page 12 to suggest the identity of M.

.....
.....
..... [1]



(f) Write an overall equation for the cell reaction which is taking place.

..... [1]

(g) The solutions contained in the two half-cells must be connected using a salt bridge.

(i) Why is a salt bridge necessary?

.....
..... [1]

(ii) Which (if any) of the following salts would be suitable to use in the salt bridge:

potassium chloride, potassium nitrate, potassium sulfate?

If you consider any to be unsuitable, explain why.

.....
.....
..... [2]

[Total: 15]

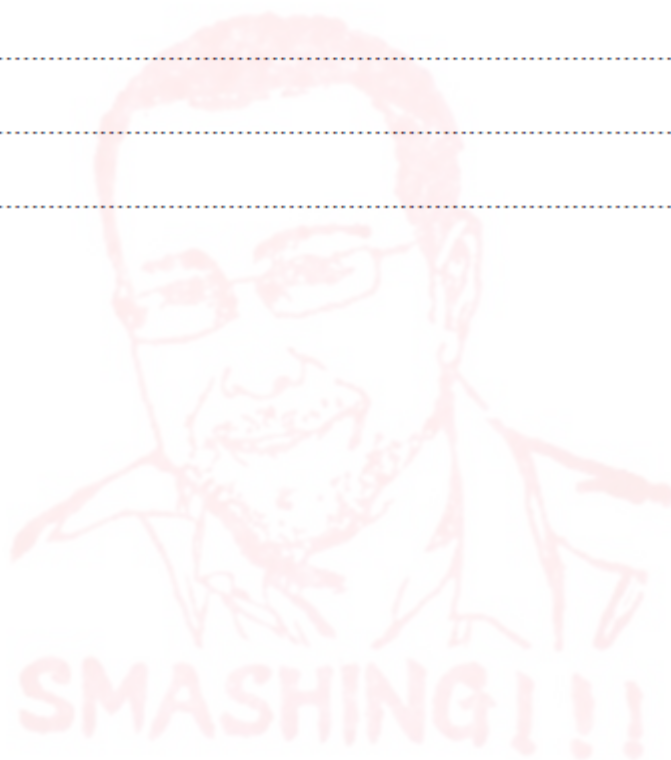

E^\ominus in decreasing order of oxidising power

Electrode reaction	E^\ominus/V
$F_2 + 2e^- \rightleftharpoons 2F^-$	+2.87
$S_2O_8^{2-} + 2e^- \rightleftharpoons 2SO_4^{2-}$	+2.01
$H_2O_2 + 2H^+ + 2e^- \rightleftharpoons 2H_2O$	+1.77
$MnO_4^- + 8H^+ + 5e^- \rightleftharpoons Mn^{2+} + 4H_2O$	+1.52
$PbO_2 + 4H^+ + 2e^- \rightleftharpoons Pb^{2+} + 2H_2O$	+1.47
$Cl_2 + 2e^- \rightleftharpoons 2Cl^-$	+1.36
$Cr_2O_7^{2-} + 14H^+ + 6e^- \rightleftharpoons 2Cr^{3+} + 7H_2O$	+1.33
$Br_2 + 2e^- \rightleftharpoons 2Br^-$	+1.07
$NO_3^- + 2H^+ + e^- \rightleftharpoons NO_2 + H_2O$	+0.81
$Ag^+ + e^- \rightleftharpoons Ag$	+0.80
$Fe^{3+} + e^- \rightleftharpoons Fe^{2+}$	+0.77
$I_2 + 2e^- \rightleftharpoons 2I^-$	+0.54
$O_2 + 2H_2O + 4e^- \rightleftharpoons 4OH^-$	+0.40
$Cu^{2+} + 2e^- \rightleftharpoons Cu$	+0.34
$SO_4^{2-} + 4H^+ + 2e^- \rightleftharpoons SO_2 + 2H_2O$	+0.17
$Sn^{4+} + 2e^- \rightleftharpoons Sn^{2+}$	+0.15
$S_4O_6^{2-} + 2e^- \rightleftharpoons 2S_2O_3^{2-}$	+0.09
$2H^+ + 2e^- \rightleftharpoons H_2$	0.00
$Pb^{2+} + 2e^- \rightleftharpoons Pb$	-0.13
$Sn^{2+} + 2e^- \rightleftharpoons Sn$	-0.14
$Fe^{2+} + 2e^- \rightleftharpoons Fe$	-0.44
$Zn^{2+} + 2e^- \rightleftharpoons Zn$	-0.76
$Mg^{2+} + 2e^- \rightleftharpoons Mg$	-2.38
$Ca^{2+} + 2e^- \rightleftharpoons Ca$	-2.87
$K^+ + e^- \rightleftharpoons K$	-2.92

SMASHING!!!



- 2** Dilute sulfuric acid, $\text{H}_2\text{SO}_4(\text{aq})$, can be electrolysed using platinum electrodes and a direct current. Hydrogen gas is produced at the cathode and oxygen gas is produced at the anode. The two gases are collected separately in burettes filled with dilute sulfuric acid placed over each electrode.

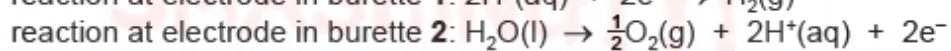
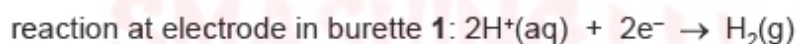
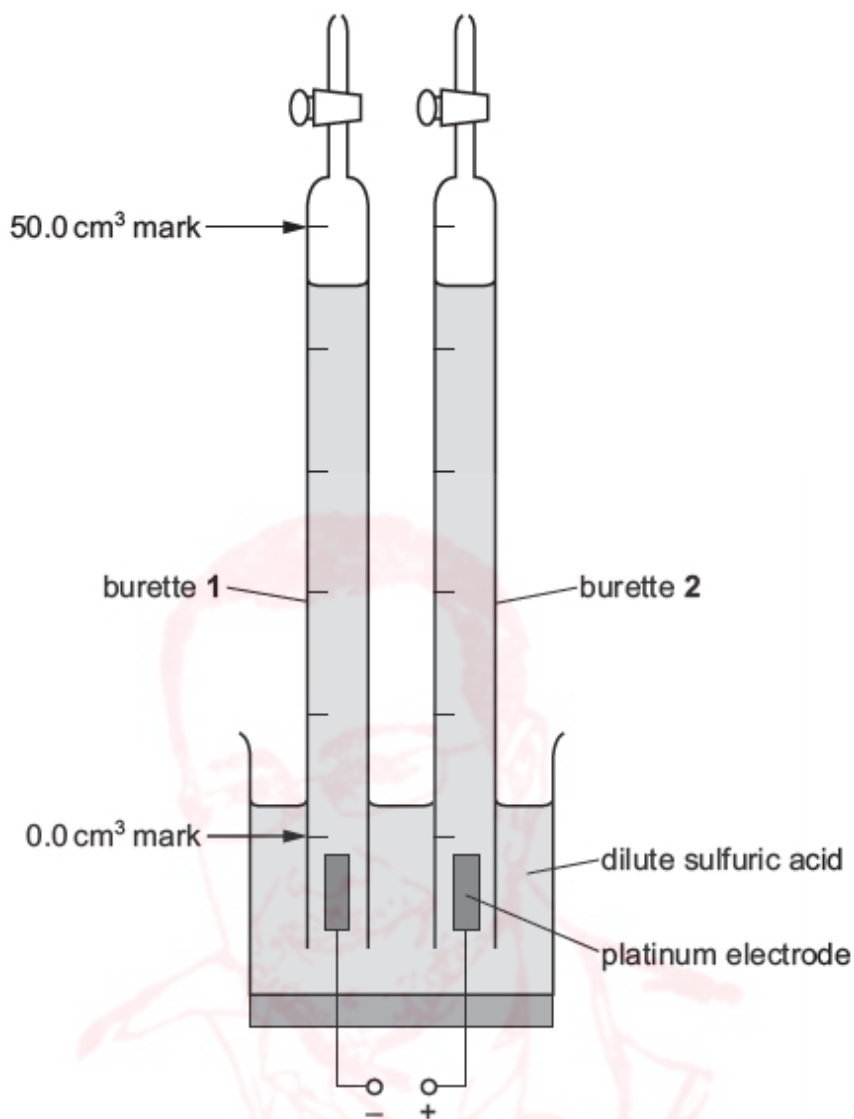

The production of hydrogen gas over time can be measured, and the data used to determine the charge of one mole of electrons, known as the Faraday constant, F .

- (a) The volumes of hydrogen gas produced during the electrolysis process are recorded in the table.

Process the results to calculate the volume of hydrogen gas produced, in cm^3 , and the charge passed, in coulombs, C.

$$\text{charge (C)} = \text{current (A)} \times \text{time (s)}$$

The current was kept constant at 0.80A.

time/s	reading on burette 1/ cm^3	volume of hydrogen gas produced/ cm^3	charge passed /C
0	46.20	0.00	
50	41.20		
100	36.20		
150	31.45		
200	25.80		
250	20.80		
300	16.40		
350	11.45		
400	6.80		
450	1.50		

[2]

(b) Plot a graph on the grid to show the relationship between volume of hydrogen gas produced and charge passed.

Use a cross (x) to plot each data point. Draw the straight line of best fit.

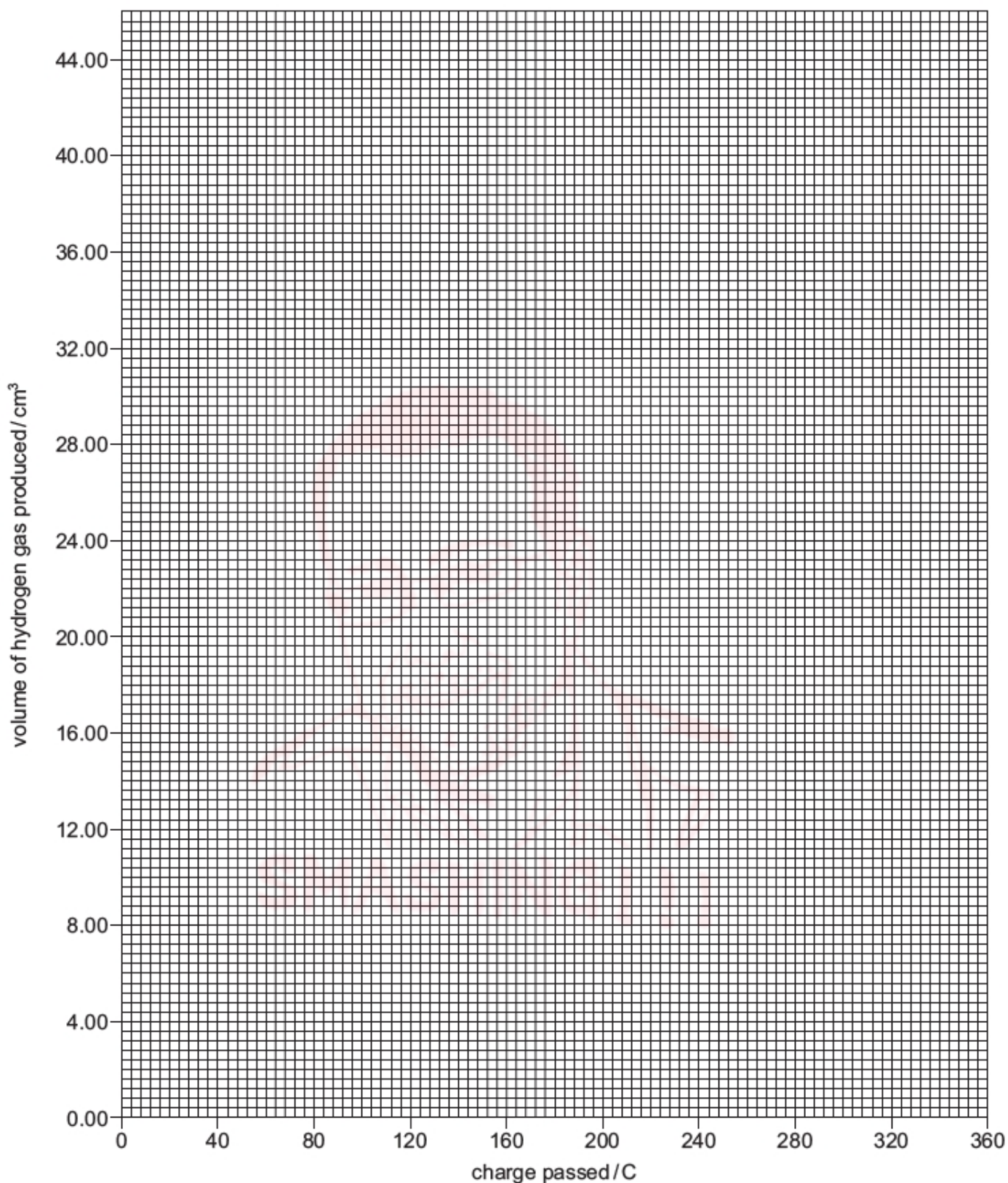

[2]

(c) Do you think the results obtained in (a) are reliable? Explain your answer.

.....
.....
..... [1]

(d) (i) The gradient of the line of best fit gives the volume of hydrogen gas produced per coulomb.

Use the graph to determine the gradient of the line of best fit.

State the co-ordinates of both points you used in your calculation.

co-ordinates 1 co-ordinates 2

gradient = $\text{cm}^3 \text{C}^{-1}$
[2]

(ii) Calculate the number of moles of hydrogen gas produced per coulomb.

If you were unable to obtain an answer for (d)(i), you may use the value $0.148 \text{ cm}^3 \text{C}^{-1}$, but this is not the correct answer.

[The molar volume of gas = 24.0 dm^3 at room temperature and pressure.]

..... molC^{-1} [1]

(iii) Use your answer to (ii) and the half-equation for the production of $\text{H}_2(\text{g})$ to calculate a numerical value for the Faraday constant (the charge of 1 mole of electrons).

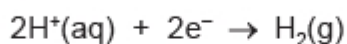

..... C mol^{-1} [1]



- (e) (i) The graph below shows the relationship between volume of $\text{H}_2(\text{g})$ produced at the cathode and time, in a similar experiment.

Draw a line on the graph to show the relationship between volume of $\text{O}_2(\text{g})$ produced at the anode and time in this experiment.

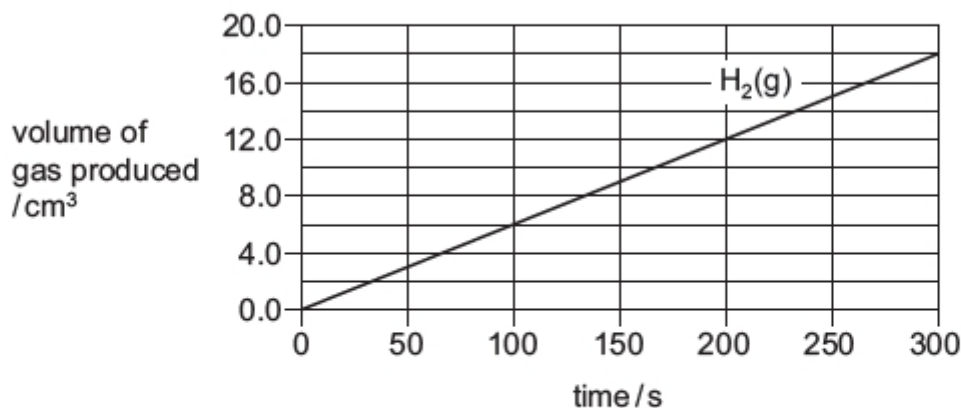

[1]

- (ii) Suggest why the volume of $\text{O}_2(\text{g})$ measured in this experiment might be **less** than that shown by your drawn line.

Assume that no gas is lost from leaks.

.....

..... [1]

- (f) In these experiments, the pressure of the gas inside the burette is assumed to be atmospheric pressure, P_{atm} .

However, the presence of water vapour and the mass of the solution in the burette change the pressure of the gas to P_{new} .

The expression below shows the relationship between P_{new} and P_{atm} .

$$P_{\text{new}} = P_{\text{atm}} - 2.81 - (9.81 \times \text{height of solution in burette})$$

- (i) Use the expression to sketch a graph on the axes below to show the relationship between P_{new} and the height of solution in the burette.

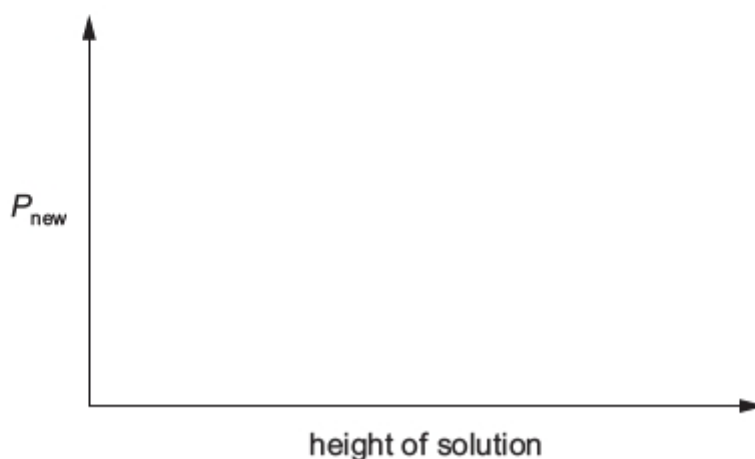

[1]

(ii) State how P_{new} changes the value of the Faraday constant calculated at P_{atm} in (d)(iii).

Explain your answer.

.....
..... [1]

(g) A student's teacher suggested it would be cheaper to use copper rather than platinum electrodes in the electrolysis of dilute sulfuric acid.

half-equation	E^\ominus/V
$2\text{H}^+(\text{aq}) + 2\text{e}^- \rightleftharpoons \text{H}_2(\text{g})$	0.00
$\text{Cu}^{2+}(\text{aq}) + 2\text{e}^- \rightleftharpoons \text{Cu}(\text{s})$	+0.34
$\frac{1}{2}\text{O}_2(\text{g}) + 2\text{H}^+(\text{aq}) + 2\text{e}^- \rightleftharpoons \text{H}_2\text{O}(\text{l})$	+1.23

Using the information in the table, suggest what effect, if any, the use of copper electrodes would have on the volume of gas produced at **each** electrode. Explain your answer.

cathode

.....
.....

anode

.....
.....

[3]

[Total: 16]



1 The Faraday constant is the charge in coulombs, C, carried by 1 mole of electrons.

(a) A student plans an electrolysis experiment to determine the Faraday constant.

The student was supplied with the following.

- 1.0 mol dm⁻³ copper(II) sulfate
- clean, dry copper foil electrodes, labelled 'anode' and 'cathode'
- balance
- stop-clock
- ammeter
- other equipment suitable for carrying out electrolysis

Draw a labelled diagram of the apparatus and chemicals the student should use in their electrolysis experiment. Include in your diagram the circuit connecting the anode and cathode.



[2]

(b) Two of the hazards of using copper(II) sulfate solution are given below.

For each hazard, state a precaution, other than eye protection and a lab coat, that the student should take when carrying out the experiment.

hazard: copper(II) sulfate solution causes skin irritation

precaution

.....

hazard: copper(II) sulfate solution is toxic to aquatic life

precaution

.....

[2]

The student carried out the electrolysis for exactly 30 minutes with a current of 0.5A.

- After the electrolysis was finished, the student removed the electrodes.
 - The electrodes were then carefully washed in water and then dipped in propanone.
 - The electrodes were dried by allowing the propanone to evaporate.
- (c)** State the measurements the student would need to record to calculate the mass change of an electrode. Include the appropriate unit.

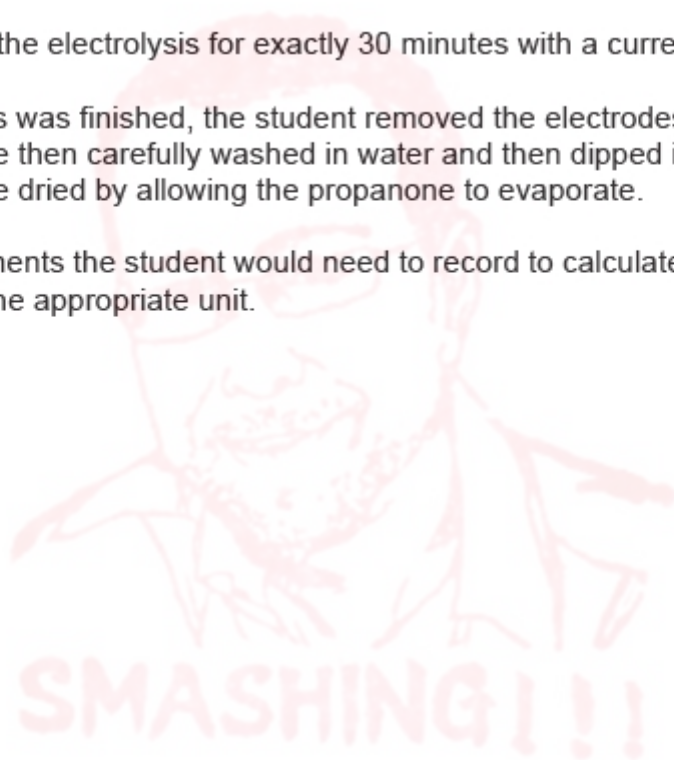

[1]

- (d) Calculate the charge passed through the copper(II) sulfate solution during the electrolysis experiment using the formula shown.

$$\text{charge (C)} = \text{current (A)} \times \text{time (s)}$$

charge passed = C [1]

- (e) The mass change of the anode was -0.282 g .

Calculate the amount, in mol, of copper lost from the anode. Give your answer to 3 significant figures.

[A_r : Cu, 63.5]

moles of copper lost from the anode = mol [1]

- (f) Use your answers to (d) and (e) to calculate the charge required to remove 1 mole of copper from the anode.

charge required to remove 1 mole of copper = C [1]

- (g) The theoretical charge required to remove 1 mole of copper from the anode into solution as copper(II) ions is $193\,000\text{ C}$.
The Faraday constant is $96\,500\text{ C mol}^{-1}$.

Explain why the theoretical charge is twice the Faraday constant.

.....
.....
..... [1]

(h) A possible source of error is not drying the anode at the start of the experiment.

Explain the effect, if any, on the calculated value of the Faraday constant if the anode is wet at the beginning of the experiment but dry at the end.

effect

explanation

[1]

(i) The student wanted to ensure that the anode was completely dry at the end of the experiment and decided to evaporate off the propanone using a blue Bunsen flame. The student noticed some blackening of the surface of the copper.

Suggest what caused this blackening.

[1]

(j) The student calculated the mass change of the anode and the cathode after the experiment was complete.

mass change of anode = -0.282 g mass change of cathode = $+0.217\text{ g}$

Suggest **one** reason why the mass gained at the cathode is **not** the same as the mass lost at the anode. Assume the student has recorded the mass changes correctly.

[1]

[Total: 12]

- 2 The solubility product, K_{sp} , of a sparingly soluble salt can be determined by measuring the cell potential of a cell known as a *concentration cell*. One of the half-cells uses a saturated solution of the salt as the electrolyte.

The K_{sp} of silver chloride, $AgCl$, can be measured using the apparatus shown.

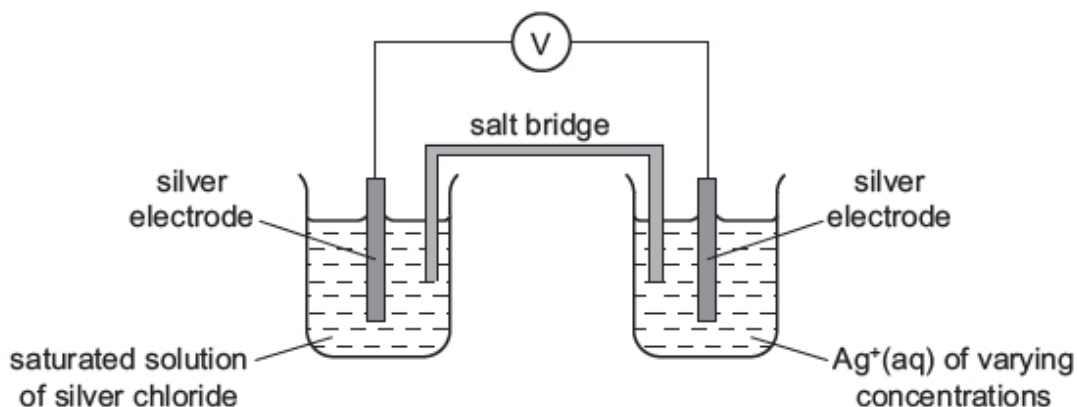

The silver electrodes of the two half-cells were connected via a voltmeter, reading to three decimal places. This measured the cell potential of the concentration cell.

The half-cells were kept at a temperature of $40^\circ C$. Under these conditions, the relationship between cell potential, E_{cell} , and $[Ag^+(aq)]$ is

$$16.1E_{cell} = \log C_{sat} - \log [Ag^+(aq)]$$

C_{sat} is the concentration of the saturated solution of silver chloride

- (a) (i) The solutions in the half-cells need to be kept at $40^\circ C$.

Explain how you would do this.

.....
 [1]

- (ii) If the temperature was maintained at $40^\circ C$, over time the reading on the voltmeter would change.

Suggest **one** reason why.

.....
 [1]

The cell potential was measured for various concentrations of $\text{Ag}^+(\text{aq})$ and the results obtained are shown in the table.

(b) Complete the fourth and fifth columns of the table.

Give each answer to **two decimal places**.

experiment	$[\text{Ag}^+(\text{aq})]$ / mol dm^{-3}	E_{cell}/V	$-\log [\text{Ag}^+(\text{aq})]$	$16.1E_{\text{cell}}/\text{V}$
1	0.00100	-0.097		
2	0.00500	-0.140		
3	0.0100	-0.159		
4	0.0250	-0.171		
5	0.0500	-0.202		
6	0.100	-0.221		
7	0.200	-0.239		
8	0.500	-0.264		
9	1.50	-0.294		

[2]

(c) (i) On the grid on page 9, plot a graph of $16.1E_{\text{cell}}$ against $-\log [\text{Ag}^+(\text{aq})]$.

Draw a line of best fit.

[2]

(ii) Circle the single most anomalous point on the graph.

The temperature of the half-cells was maintained at 40°C . Suggest what error in the experimental set-up may have caused the anomaly.

.....

.....

..... [2]

(iii) Use your graph and the equation to determine a value for $\log C_{\text{sat}}$.

$$16.1E_{\text{cell}} = \log C_{\text{sat}} - \log [\text{Ag}^+(\text{aq})]$$

$$\log C_{\text{sat}} = \dots\dots\dots [1]$$



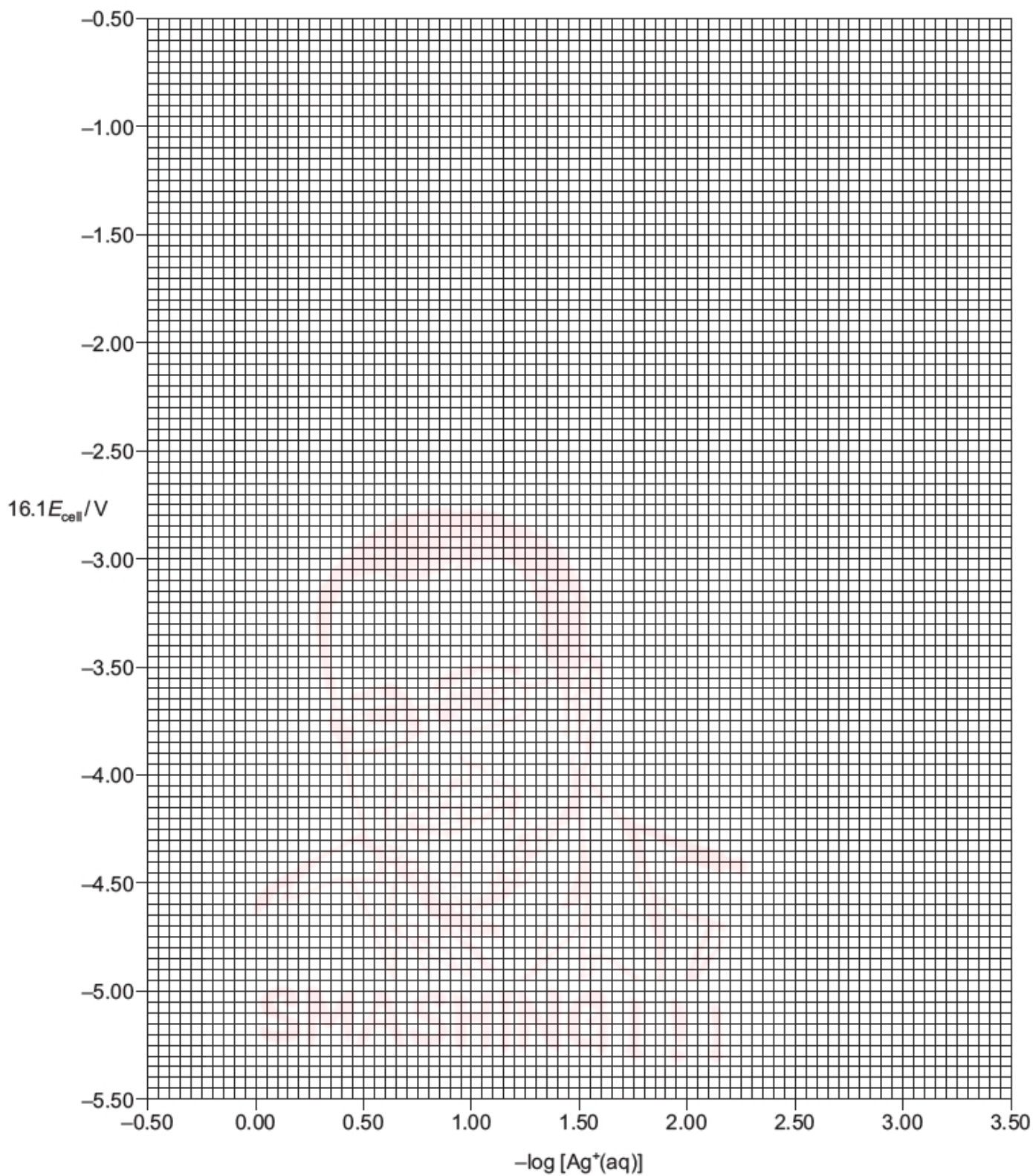

(d) To carry out these experiments, $\text{Ag}^+(\text{aq})$ of concentration 2.0 mol dm^{-3} was prepared.

(i) For experiment 6, calculate the volume of $2.0 \text{ mol dm}^{-3} \text{ Ag}^+(\text{aq})$ needed to prepare exactly 250.0 cm^3 of $\text{Ag}^+(\text{aq})$ in a 250.0 cm^3 volumetric flask.

volume = cm^3 [1]

(ii) Name a suitable piece of apparatus which could be used to measure the volume calculated in (i).

.....[1]

(e) (i) The relationship between the solubility product, K_{sp} , and the concentration of the saturated solution of silver chloride, C_{sat} , is shown.

$$K_{\text{sp}} = C_{\text{sat}}^2$$

Use this equation and your answer to (c)(iii) to calculate a value for K_{sp} .

Give your answer to **three significant figures**.

(If you have no answer for (c)(iii), use a value of -4.20 but this is **not** the true value.)

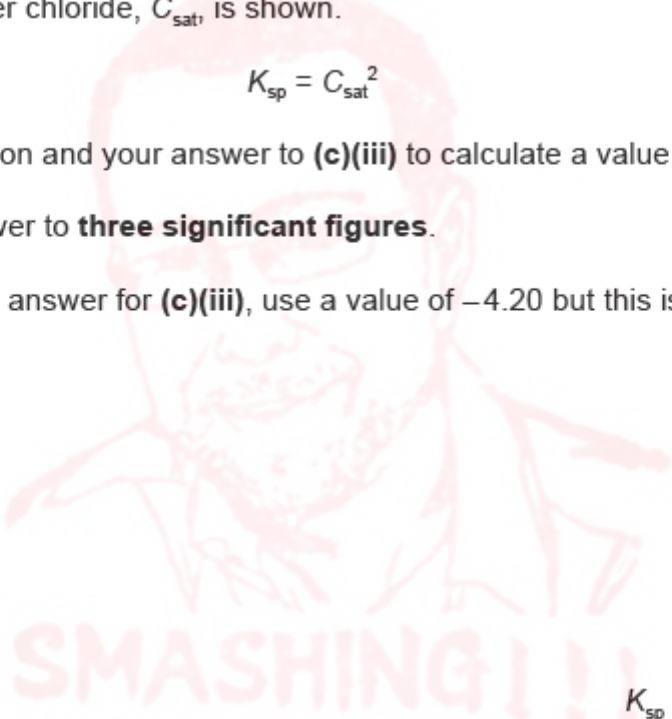

$K_{\text{sp}} = \dots\dots\dots$ [2]

(ii) The solubility of AgCl increases with temperature.

Using the axes below, sketch a graph to show how the K_{sp} of AgCl varies with temperature.

Label both axes.

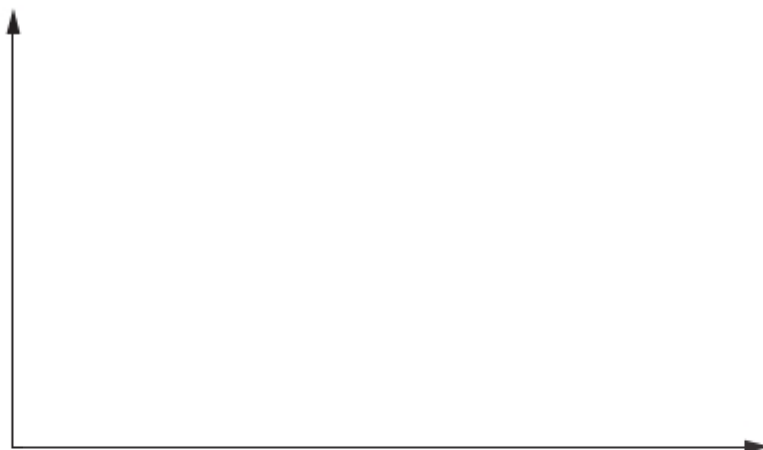

[1]

(f) The salt bridge in a concentration cell commonly contains a solution of one of the following compounds.

potassium chloride potassium nitrate sodium chloride

Identify which, if any, of these compounds would **not** be suitable for use in the salt bridge in this experiment.

Explain your answer.

.....

.....

.....

[2]

[Total: 16]

1 A student investigates the charge ($z+$) carried by aqueous manganese ions, $Mn^{z+}(aq)$. The electrochemical cell shown is set up for this investigation with the following two half-cells:

- a standard copper(II) ion / copper half-cell ($E^\ominus = +0.340\text{ V}$)
- a half-cell made from manganese and $0.500\text{ mol dm}^{-3} Mn^{z+}(aq)$.

(a) Label the items **P** and **Q** and state the concentration of the copper(II) ion solution in the copper half-cell.

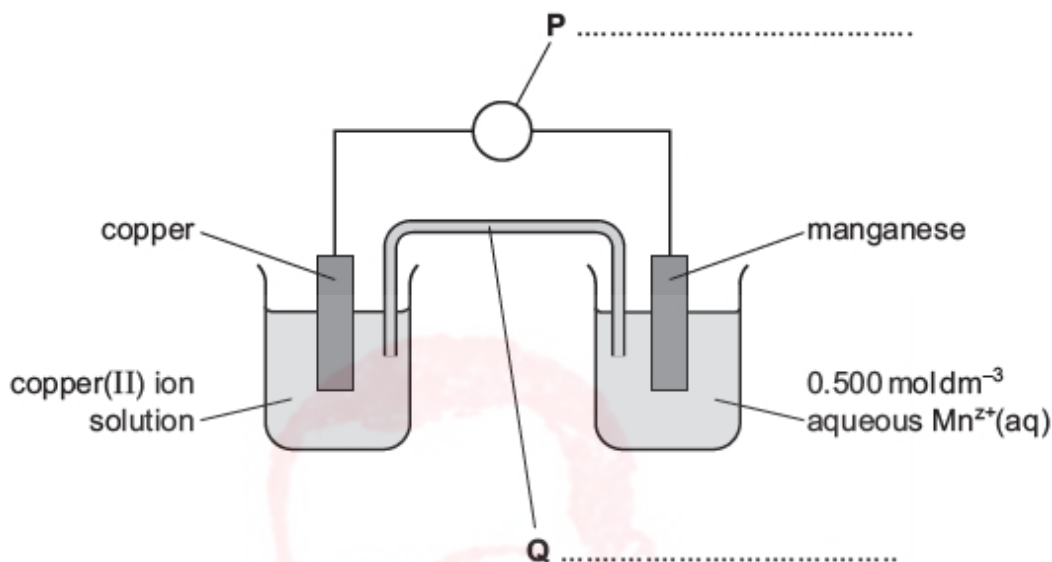

concentration of the copper(II) ion solution in the copper half-cell = [1]

(b) During the investigation the student plans to use solutions of $Mn^{z+}(aq)$ of lower concentration than 0.500 mol dm^{-3} .

(i) Calculate the volume of $0.500\text{ mol dm}^{-3} Mn^{z+}(aq)$ needed to prepare 100.0 cm^3 of $0.200\text{ mol dm}^{-3} Mn^{z+}(aq)$.

SMASHING!!!

volume = cm^3 [1]

- (ii) Describe how, using a 100 cm³ volumetric flask, the student should prepare exactly 100.0 cm³ of 0.200 mol dm⁻³ Mn²⁺(aq) using the volume of 0.500 mol dm⁻³ Mn²⁺(aq) calculated in (b)(i) and standard school or college apparatus.

.....

.....

.....

.....

.....

..... [2]

The cell potential of the electrochemical cell in (a) is measured. The 0.500 mol dm⁻³ Mn²⁺(aq) is then replaced by the 0.200 mol dm⁻³ solution and the cell potential is measured again. This is repeated for other lower concentrations of Mn²⁺(aq). All measurements are made at 25 °C.

- (iii) The results of the experiment are shown in the table.

Complete column three of the table, calculating log[Mn²⁺] to **two decimal places**.
Complete column four of the table, calculating *E*, the electrode potential of each manganese half-cell, to **three decimal places**, using the equation shown.

$$E(\text{manganese half-cell}) = E_{\text{cell}} + 0.340 \text{ V}$$

[Mn ²⁺] /mol dm ⁻³	cell potential, <i>E</i> _{cell} /V	log[Mn ²⁺]	electrode potential of each manganese half-cell, <i>E</i> /V
5.0 × 10 ⁻¹	-1.529	-0.30	-1.189
2.0 × 10 ⁻¹	-1.541		
1.0 × 10 ⁻¹	-1.550		
7.5 × 10 ⁻²	-1.553		
2.5 × 10 ⁻²	-1.567		
8.0 × 10 ⁻³	-1.582		
6.0 × 10 ⁻³	-1.590		
4.0 × 10 ⁻³	-1.591		
3.0 × 10 ⁻³	-1.594		
5.0 × 10 ⁻⁴	-1.617		

[2]



(c) Plot a graph of electrode potential of manganese half-cell (y-axis) against $\log[\text{Mn}^{2+}]$ (x-axis). Use a cross (x) to plot each data point. Draw a line of best fit.

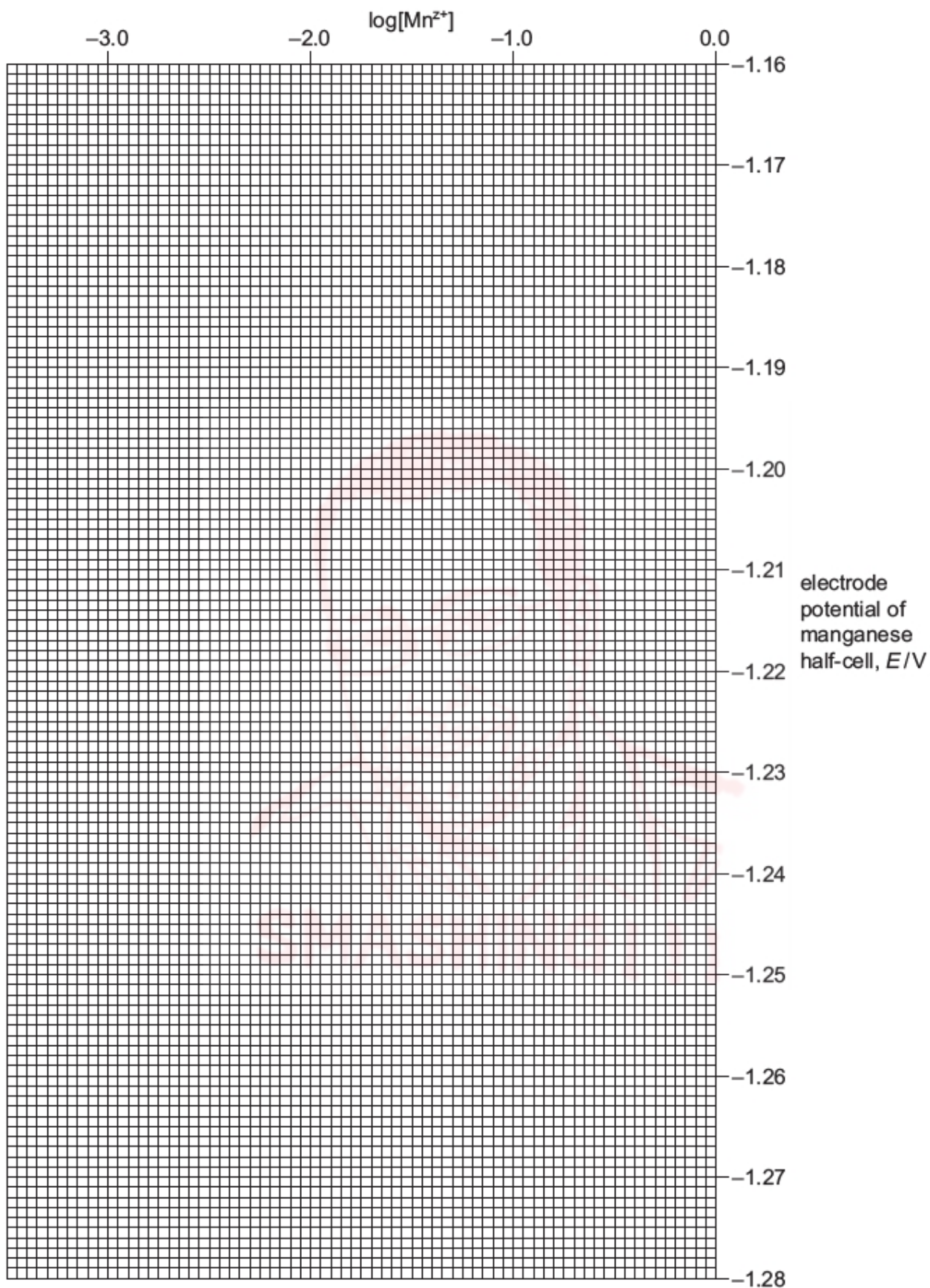

[2]

(d) (i) Circle the most anomalous point on your graph. [1]

(ii) The student is careful to ensure that all solutions used are at the same temperature in all experiments.

Suggest a possible explanation for the position of the anomalous point circled in (d)(i) relative to the line of best fit.

.....
.....
..... [1]

(e) Your graph is a plot of E against $\log[\text{Mn}^{2+}]$ and can be analysed using the Nernst equation at 25 °C.

$$E = E^\circ + \frac{0.059}{z} \log[\text{Mn}^{2+}]$$

z is the value of the charge carried by the manganese ion

E is the electrode potential/V

E° is the standard electrode potential/V

Use the Nernst equation and your graph to find the standard electrode potential, E° , of the manganese half-cell.

$E^\circ = \dots\dots\dots$ V [1]

(f) (i) Determine the gradient of the graph.
State the co-ordinates of both points you used for your calculation.
Record the value of the gradient to **three significant figures**.

co-ordinates 1 co-ordinates 2



gradient = [2]



- (ii) Use your answer to (f)(i) and the Nernst equation to calculate the value of z to three significant figures and give the formula of the manganese ion. Your calculation **must** show the use of the Nernst equation.

(If you were unable to calculate an answer to (f)(i) you may use the value 0.0197. This is **not** the correct value.)

$z =$

formula of manganese ion =
[2]

- (g) Lowering $[Mn^{2+}]$ causes the value of the electrode potential of the manganese half-cell to become more negative.

Suggest why this happens.

.....
..... [1]

[Total: 16]

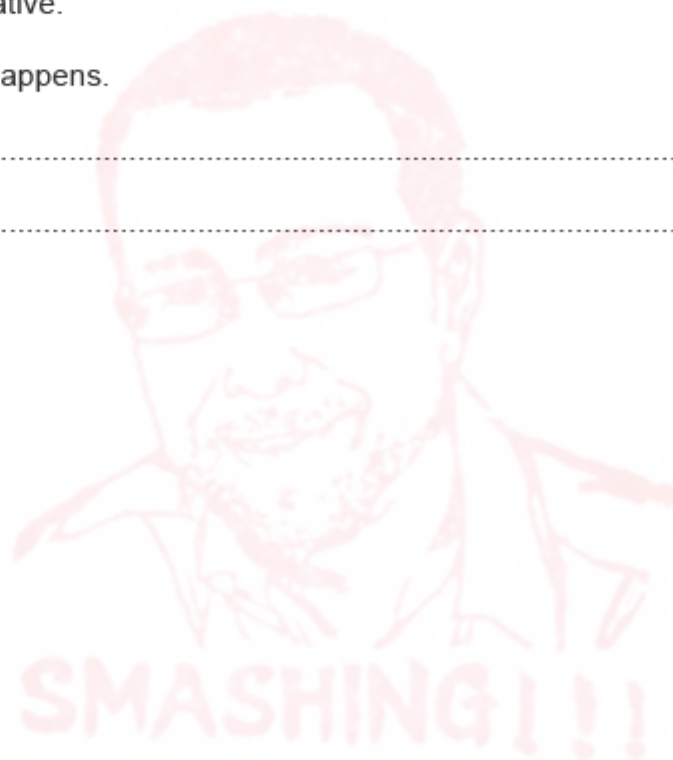

Thermometric

Topic Chem 5 Thermometric Q# 74/ ALvl Chemistry/2003/w/TZ 1/ Paper 5/Q# 1/www.SmashingScience.org

EXPERIMENT Required, no longer needed from 2007 onwards.

- 1 **FB 1** is 2.00 mol dm^{-3} hydrochloric acid, HCl .
FB 2 is solid sodium carbonate, Na_2CO_3 .
FB 3 is solid sodium hydrogen carbonate, NaHCO_3 .

You are to determine, by experiment, the enthalpy change ΔH_1 for the reaction

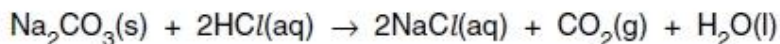

and the enthalpy change ΔH_2 for the reaction



You are then to use the results of your experiments to calculate the enthalpy change, ΔH_3 for the reaction

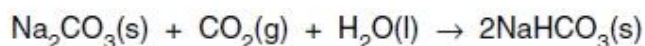

Experiment 1

Weigh the tube labelled **Tube 1**, which contains **FB 2**, solid sodium carbonate and record the mass in Table 1.1.

Table 1.1

Mass of tube 1 + FB 2	/ g	
Mass of tube 1 + residual FB 2	/ g	
Mass of FB 2 added	/ g	

[1]

Place a plastic (expanded polystyrene) cup inside a 250 cm^3 beaker for stability.

Using a measured cylinder, place 50.0 cm^3 of **FB 1**, aqueous hydrochloric acid, into the plastic cup. Measure and record the temperature of **FB 1** in Table 1.2.

Tip the sodium carbonate from **Tube 1** into the plastic cup, stir carefully and measure the maximum temperature obtained. Record this temperature in Table 1.2 and calculate the temperature rise.

It does not matter if some solid remains in the tube. Reweigh **Tube 1** (and stopper), together with any residual solid. Record the mass in Table 1.1 and calculate the mass of **FB 2** added to the acid.

Table 1.2

Initial temperature of FB 1	/ °C	
Maximum temperature after reaction	/ °C	
Temperature rise during reaction	/ °C	

[1] + [3]



- (a) Calculate the heat change in the cup during the reaction of solid sodium carbonate and hydrochloric acid.
[You may assume that 4.3 J are required to raise the temperature of 1 cm³ of solution by 1 °C]

[1]

- (b) By reference to the volume of **FB 1**, the mass of **FB 2** and the equation for the reaction, show which of the reagents **FB 1** or **FB 2** was in excess.
[A_r: Na, 23.0; C, 12.0; O, 16.0.]

[1]

- (c) Calculate ΔH_1 for the following reaction.

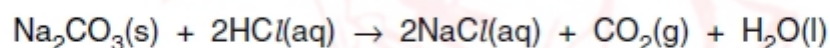

Give your answer correct to 3 significant figures and include the correct sign and units.

[2]

Experiment 2

Weigh the tube labelled **Tube 2**, which contains **FB 3**, solid sodium hydrogen carbonate and record the mass in Table 1.3.

Table 1.3

Mass of tube 2 + FB 3	/ g	
Mass of tube 2 + residual FB 3	/ g	
Mass of FB 3 added	/ g	

[1]

Empty and rinse the plastic cup used in *Experiment 1*. Replace the cup in the 250 cm³ beaker.

Use the measuring cylinder to place 50.0 cm³ of **FB 1**, aqueous hydrochloric acid, into the plastic cup. Measure and record the temperature of **FB 1** in Table 1.4.

Tip the sodium carbonate from **Tube 2** into the plastic cup, stir carefully and measure the minimum temperature obtained. Record this temperature in Table 1.4 and calculate the temperature change.

Record the mass of the tube and any residual solid in Table 1.3 and calculate the mass of **FB 3** added to the acid.

Table 1.4

Initial temperature of FB 1	/ °C	
Minimum temperature after reaction	/ °C	
Decrease in temperature during reaction	/ °C	

[1] + [3]

(d) Calculate the heat change in the cup during the reaction of solid sodium hydrogen carbonate and hydrochloric acid.

[You may assume that 4.3 J are required to raise the temperature of 1 cm³ of solution by 1 °C]

[1]

- (e) Calculate the number of moles of sodium hydrogen carbonate, NaHCO_3 , used in the experiment
[A_r : Na, 23.0; C, 12.0; H, 1.0; O, 16.0.]

[1]

- (f) Assuming that the hydrochloric acid, **FB 1**, is in excess, calculate ΔH_2 for the following reaction.



Give your answer correct to 3 significant figures and include the correct sign and units.

[2]

- (g) Use the equations

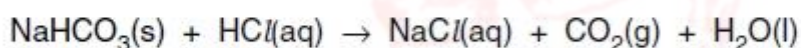
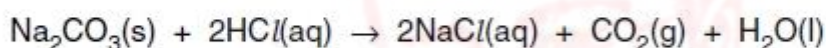

and the calculated values of ΔH_1 and ΔH_2 to calculate the enthalpy change, ΔH_3 , for the following reaction, where the enthalpy change cannot be measured directly by experiment.

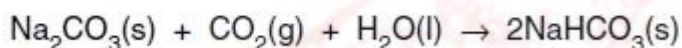

[2]

EXPERIMENT Required, no longer needed from 2007 onwards.1 **FB 1** is zinc powder, Zn.**FB 2** is 0.8 mol dm^{-3} copper sulphate, CuSO_4 .

You are required to determine the temperature and enthalpy changes for the following reaction.



- (a) Accurately weigh, to two decimal places, an empty weighing bottle. Place between 2.90 g and 3.00 g of **FB 1**, zinc powder, into the weighing bottle. Record your weighings in Table 1.1 below. If your balance has a Tare facility, do **not** use it.

Table 1.1 – Weighing of FB 1

mass of empty weighing bottle	/ g	
mass of weighing bottle + FB 1	/ g	
mass of weighing bottle + residual FB 1	/ g	
mass of FB 1 placed in plastic cup	/ g	

[2]

- (b) Place the plastic cup in the 250 cm^3 beaker provided and pipette 25.0 cm^3 of **FB 2** into the plastic cup.

Stir gently with the thermometer and take the temperature of the solution every half minute for $2\frac{1}{2}$ minutes. Record the temperature readings in Table 1.2 overleaf on page 4.

At exactly 3 minutes, add the **FB 1** from the weighing bottle to the plastic cup.

Do not try to read the temperature at 3 minutes.

Stir the mixture thoroughly, and continue to stir and record the temperature every half minute from $3\frac{1}{2}$ minutes to 15 minutes.

- (c) Reweigh the weighing bottle and any residual zinc powder and record the mass in Table 1.1 above.



Table 1.2 – Temperature readings

<i>time / min</i>	<i>temperature / °C</i>	<i>time / min</i>	<i>temperature / °C</i>
0		8	
½		8½	
1		9	
1½		9½	
2		10	
2½		10½	
3		11	
3½		11½	
4		12	
4½		12½	
5		13	
5½		13½	
6		14	
6½		14½	
7		15	
7½			

[1] + [8]

(d) Plot a graph of temperature against time on the grid opposite. [3]

(e) Extrapolate the cooling section of your graph back to time = 3 minutes and read the corresponding temperature.

Estimated temperature = °C

Use this value to obtain the temperature change produced by the reaction.

Temperature change = °C

[1]

temperature
/°C

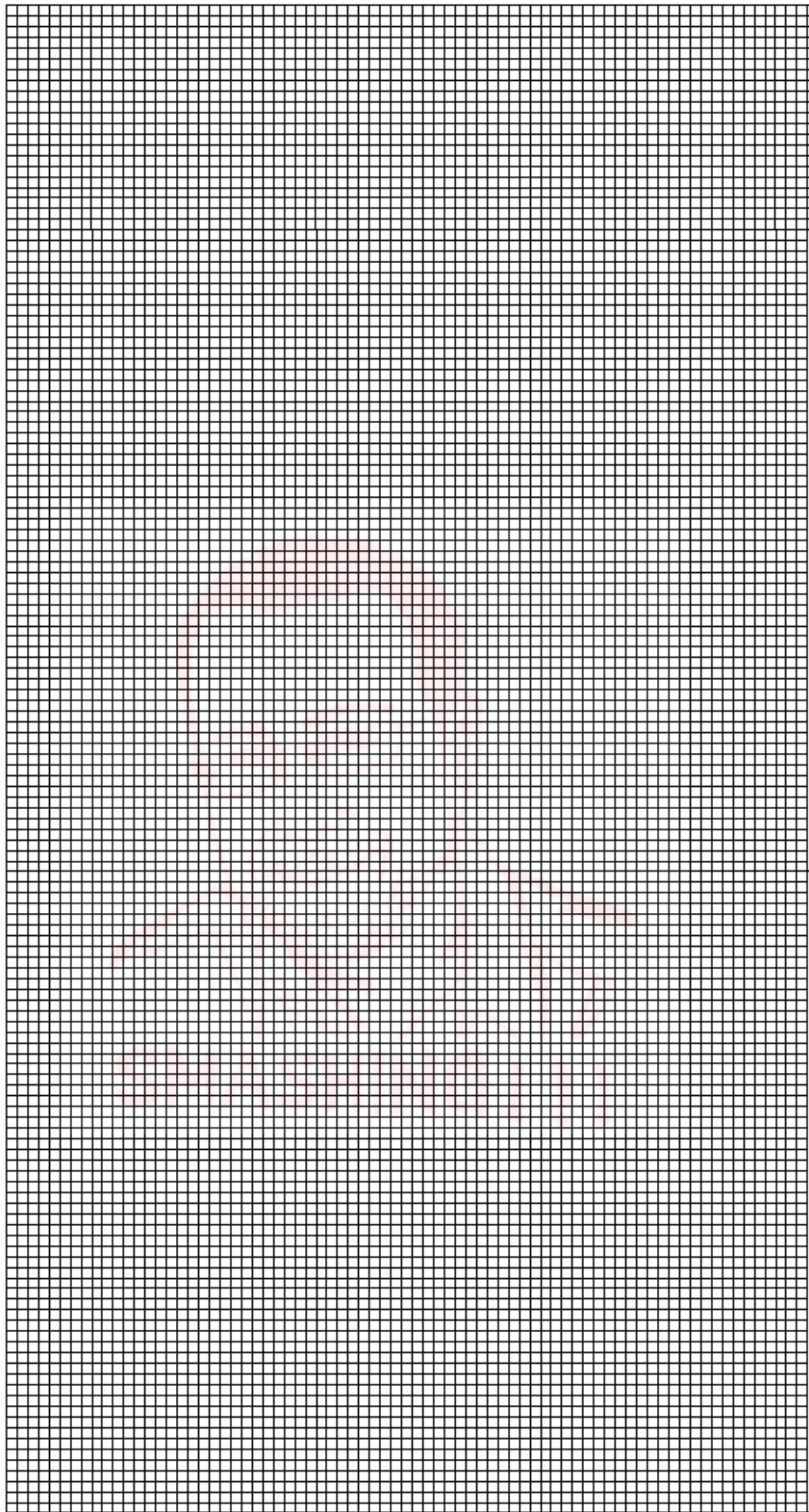

time / min



- (f) Calculate how many moles of zinc were added to the plastic cup.
[A_r : Zn, 65.4.]

[1]

- (g) Calculate how many moles of copper sulphate, CuSO_4 , were added to the plastic cup.

[1]

- (h) Calculate the heat energy produced when the zinc is added to the aqueous copper sulphate in the plastic cup.
[You may assume that 4.3 J are required to raise the temperature of 1 cm^3 of any dilute solution by 1°C .]

[1]

- (i) Calculate the enthalpy change, ΔH , for the reaction. Include the sign and units in your answer.

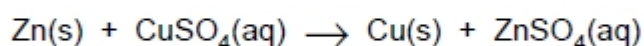

$\Delta H = \dots\dots\dots$ [1]

[Total: 19]



- 1 The equations for the complete combustion of the first five members of the alcohol homologous series are shown below.

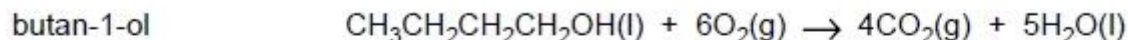
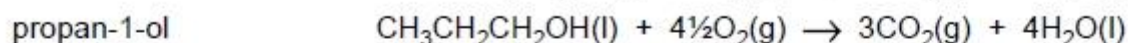
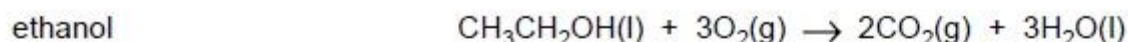
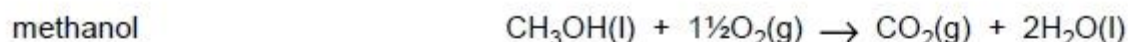

You are to plan an experiment to determine the enthalpy change of combustion under laboratory conditions, ΔH_c , for each of the five alcohols using the apparatus and information below.

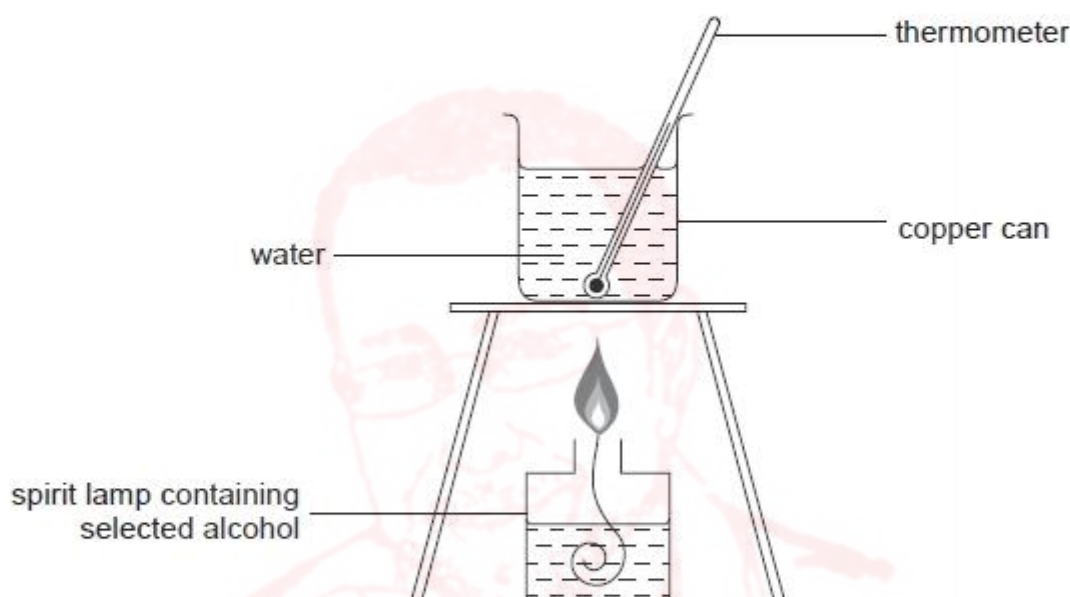

[4.2 J of heat energy raise the temperature of 1 cm³ (1 g) of water by 1 °C.]

- (a) Inspection of the products of the five equations shows that from ethanol to pentan-1-ol each equation has one more mole of CO₂ and one more mole of H₂O produced per mole of alcohol than the equation above it.

What difference between the structures of adjacent alcohols is responsible for these additional combustion products?

.....[1]

- (b) There is a trend in ΔH_c for these five alcohols. Use your answer to (a) to sketch the trend indicated by the equations.

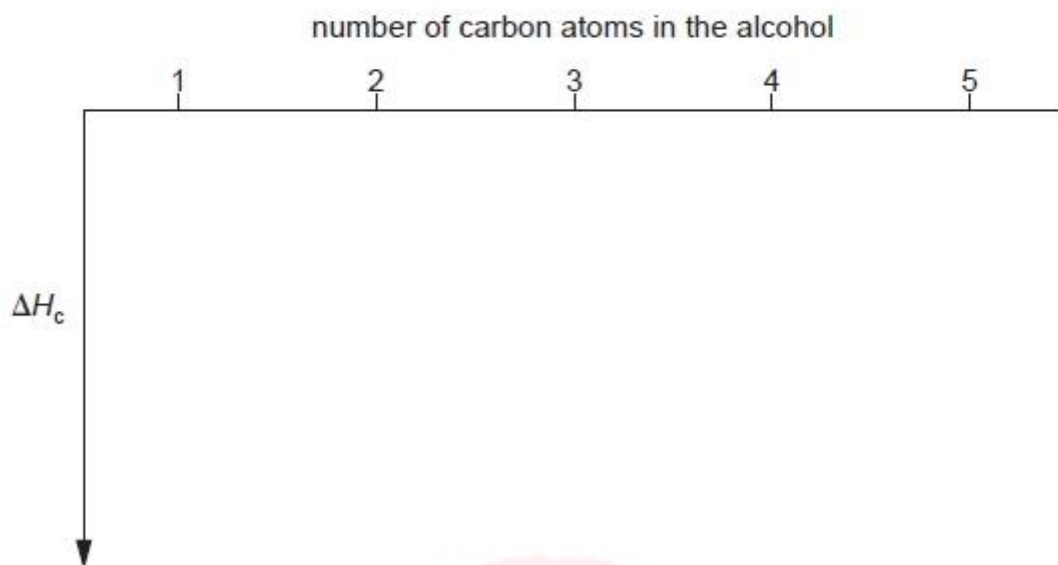

[1]

- (c) Identify each of the following variables in the experiment to determine the enthalpy change of combustion of an alcohol using the apparatus in the diagram.

The independent variable is

The dependent variable is

Two variables to be controlled in this experiment are

1

2

[3]

- (f) The apparatus shown in the diagram on page 2 and used in the experiment you have described is inefficient as much of the energy released from the burning alcohol is lost to the atmosphere.
You are to plan **two simple changes** to the apparatus shown on page 2 that will reduce the loss of heat energy to the atmosphere.
Draw a diagram of your improved apparatus, indicating and explaining how these changes will reduce the loss of heat energy.

improvement 1

.....
.....
.....
.....
.....
.....

improvement 2

.....
.....
.....
.....
.....

[2]

[Total: 15]



- 2 A student carried out a series of experiments to determine the enthalpy change of combustion of ethanol, C_2H_5OH .

A diagram of the apparatus is shown below.

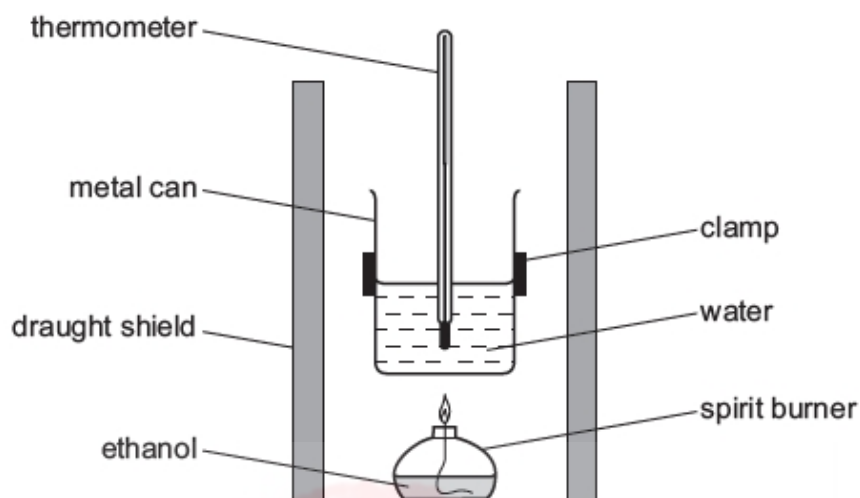

The ethanol in the spirit burner was burned to heat a measured mass of water in the metal can. The student recorded the initial and final mass of ethanol and the initial and final temperature of the water for each experiment.

- (a) Process the results in the table to calculate the amount of ethanol burned and the energy transferred to the water in each experiment.

Record all answers to **three** significant figures.
 [Specific heat capacity of water, $c = 4.18 \text{ J g}^{-1} \text{ K}^{-1}$]
 [A_r : C, 12.0; H, 1.0; O, 16.0]

experiment number	mass of ethanol burned/g	temperature change/ $^{\circ}\text{C}$	mass of water heated/g	amount of ethanol burned/mol	energy transferred to the water/kJ
1	0.391	19.5	40.0		
2	0.488	23.6	40.0		
3	0.506	24.5	40.0		
4	0.559	26.9	40.0		
5	0.727	33.6	40.0		
6	0.597	31.1	40.0		
7	0.410	20.3	40.0		
8	0.681	31.7	40.0		

[2]

(b) Plot a graph on the grid below to show how the energy transferred to the water varies with the amount of ethanol burned. Draw the line of best fit.

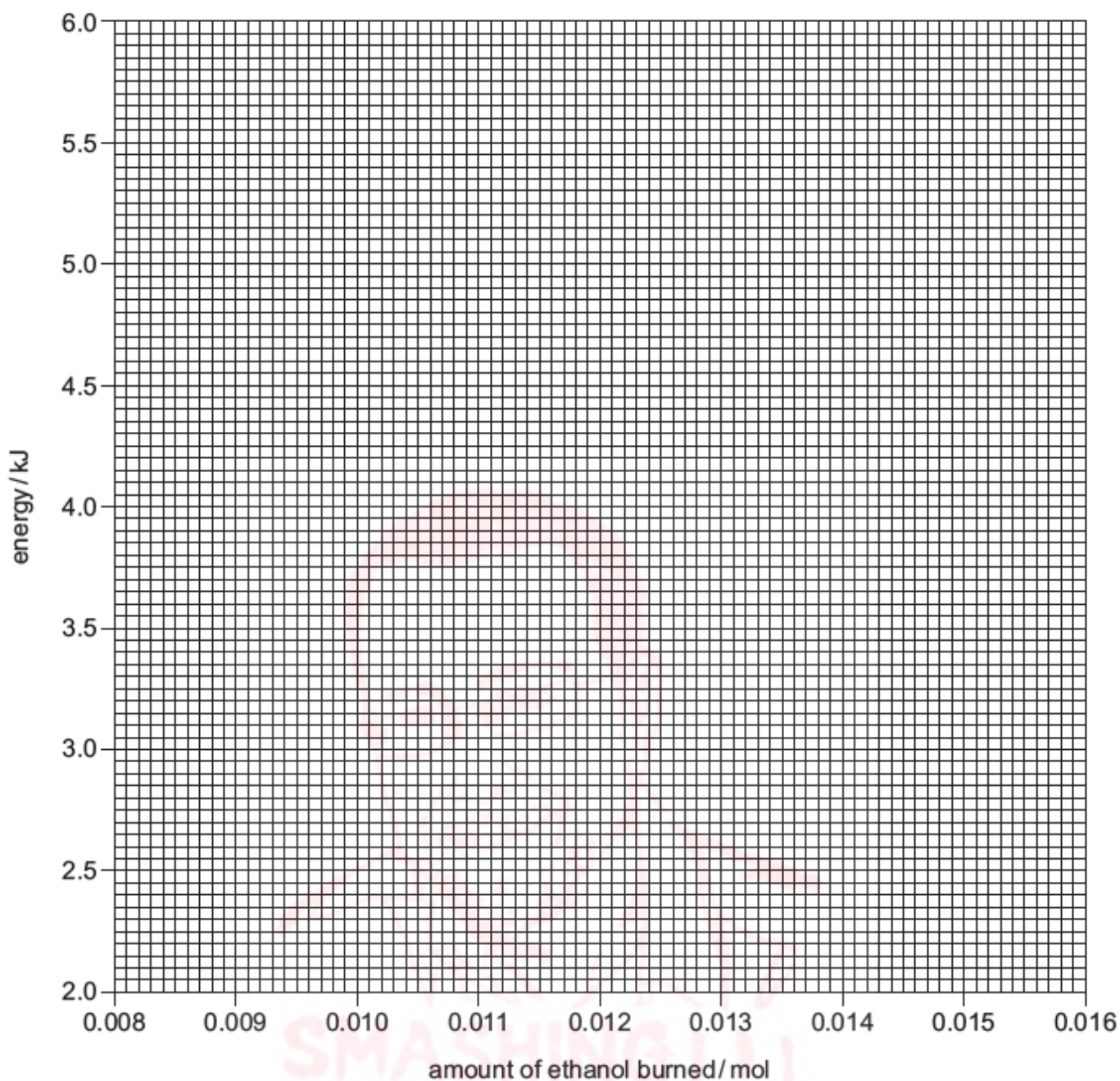

[2]

(c) Write the number of the experiment which gave the result which was most anomalous.

..... [1]

(d) The gradient of the graph gives the magnitude of the enthalpy change of combustion of ethanol.

Determine the gradient of your graph. State the co-ordinates of the **two** points you used for your calculation. Record the value of the gradient to **three** significant figures.

co-ordinates of two points used

gradient = kJ mol^{-1}
[2]

(e) Under the same conditions of temperature and pressure as these experiments, the accepted value for the enthalpy change of combustion of ethanol is $-1370 \text{ kJ mol}^{-1}$.

Explain why this value is a negative number.

..... [1]

(f) (i) Calculate the maximum percentage error in the measurement of each mass used in experiment 1.

mass measured	maximum error in a single reading	maximum percentage error / %
0.391 g of ethanol burned	0.0005 g	
40.0 g of water	0.05 g	

[1]

(ii) Another student repeated the experiments using the method described under the same conditions. The value obtained for the enthalpy change of combustion of ethanol was -612 kJ mol^{-1} .

Suggest a reason why the errors calculated in (i) do not fully account for the difference between the student's value and the accepted value for enthalpy change of combustion, $-1370 \text{ kJ mol}^{-1}$.

.....
..... [1]

[Total: 10]

- 1 The pain of muscle strains and swellings can be eased by using heat packs. As a source of heat, some heat packs use the energy released when anhydrous calcium chloride dissolves in water.

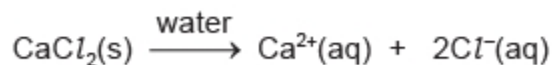

A heat pack consists of a bag of water, inside which a smaller bag contains anhydrous calcium chloride. When pressure is applied to the heat pack, the smaller bag bursts releasing the anhydrous calcium chloride into the water. The heat pack is shaken to speed up dissolving. Energy is released which warms the heat pack.

A student carried out an experiment to determine the enthalpy change when anhydrous calcium chloride dissolves in distilled water. The results the student obtained are plotted on the graph on page 4.

- (a) By considering the graph of results, draw a labelled diagram of the experimental set-up that the student could have used to produce the graph shown.
Label the apparatus and chemicals required to measure the **two** variables.



[2]

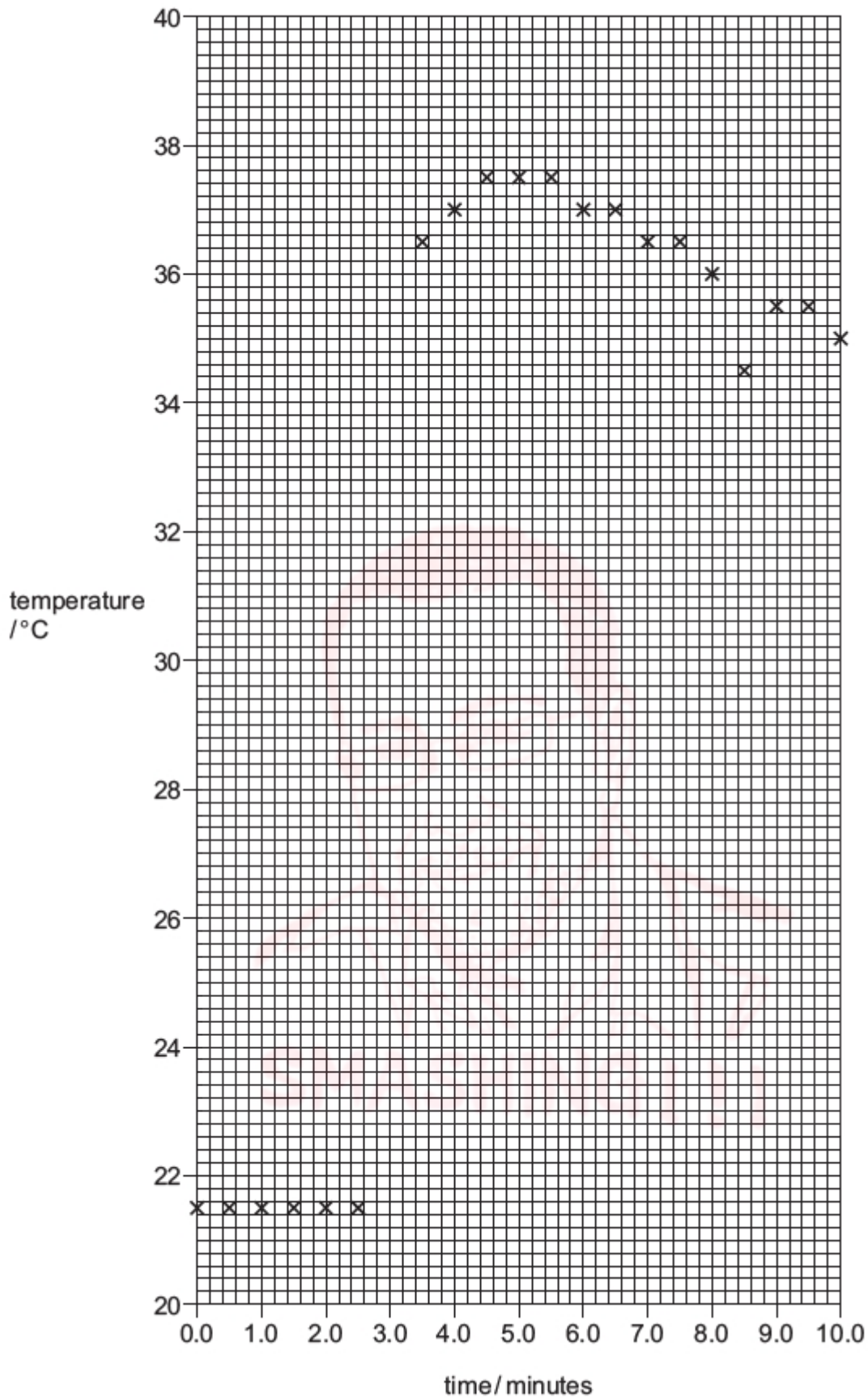

(b) Explain why the student took readings between 0.0 minutes and 2.5 minutes.

.....
..... [1]

(c) Explain why the student did not take a reading at 3.0 minutes.

.....
..... [1]

(d) Explain why the temperature continued to increase between 3.5 minutes and 4.5 minutes.

.....
..... [1]

(e) Draw two straight lines of best fit on the grid. Extrapolate these lines to estimate the theoretical temperature rise at 3.0 minutes. Give your answer to **one** decimal place.

theoretical temperature rise at 3.0 minutes = °C [2]

(f) One of the results is anomalous. This occurred because the student took the thermometer out of the solution and then replaced it just before the reading was taken.

The time at which the anomalous reading was taken was minutes.

Explain why these actions led to the anomalous point.

.....
..... [1]



(g) Explain why stirring the mixture would make this experiment more reliable.

.....
.....
..... [1]

(h) Anhydrous calcium chloride is classified as a moderate health hazard. It is an irritant.

Apart from wearing eye protection, state **one** other relevant safety precaution the student should have taken.

.....
..... [1]

(i) The student found the value for the enthalpy change of solution of anhydrous calcium chloride to be $-82.5 \text{ kJ mol}^{-1}$.

A manufacturer produces a heat pack that contains 75.0 g of water.

Calculate the mass of anhydrous calcium chloride the manufacturer must use in the inner bag to produce a rise in temperature of $30.0 \text{ }^\circ\text{C}$.

The specific heat capacity of water, $c = 4.18 \text{ J g}^{-1} \text{ K}^{-1}$.

[A_r : Ca, 40.1; Cl, 35.5]

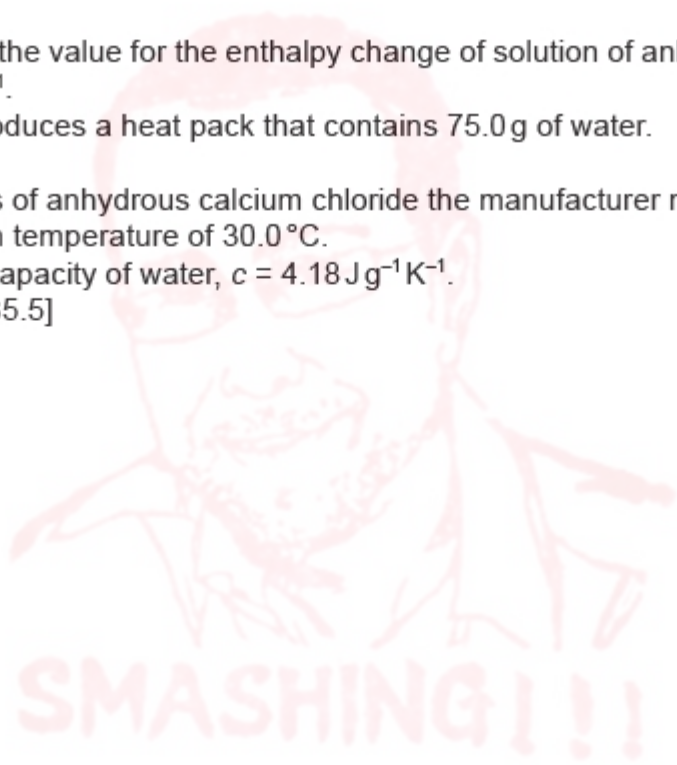

mass of anhydrous $\text{CaCl}_2 = \dots\dots\dots \text{ g}$ [2]

[Total: 12]

- 1 Trichloromethane and propanone are both organic liquids. The molecules within each liquid are attracted to each other by relatively weak permanent dipole-dipole interactions.

When trichloromethane is mixed with propanone a strong electrostatic attraction forms between the two different molecules.

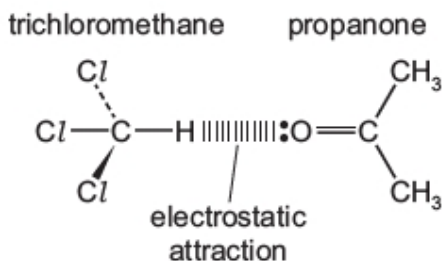

A student plans to perform an experiment to investigate the strength of this electrostatic attraction by finding the temperature change when equal volumes of trichloromethane and propanone are mixed together.

- (a) (i) State and explain your prediction (i) for the temperature change for this experiment.

.....

 [1]

- (ii) The student is given **only** the following equipment and chemicals for the experiment.

- 1 × 25 cm³ beaker
- 2 × thermometers
- 2 × 25 cm³ measuring cylinders
- 50 cm³ trichloromethane
- 50 cm³ propanone

Outline the method the student should use in this one experiment to find the temperature change when trichloromethane is mixed with propanone. Give details of the volumes of liquids used and any readings taken.

volumes used

readings taken

method used

[3]



(b) The apparatus used leads to significant heat loss.

State **one** improvement the student could make to the apparatus to reduce heat loss.

.....
..... [1]

(c) Trichloromethane and propanone are both volatile and flammable.

State **one** relevant precaution that should be taken when carrying out this experiment.

.....
..... [1]

(d) State **one** change, apart from reducing heat loss, that could be made to improve the accuracy of this experiment.

.....
..... [1]

(e) In another experiment, a student uses 37.50 g of trichloromethane and 19.75 g of propanone and determines that the energy released is 1.67 kJ.

(i) Calculate the number of moles of each compound in this mixture.

M_r trichloromethane = 119.5
 M_r propanone = 58.0

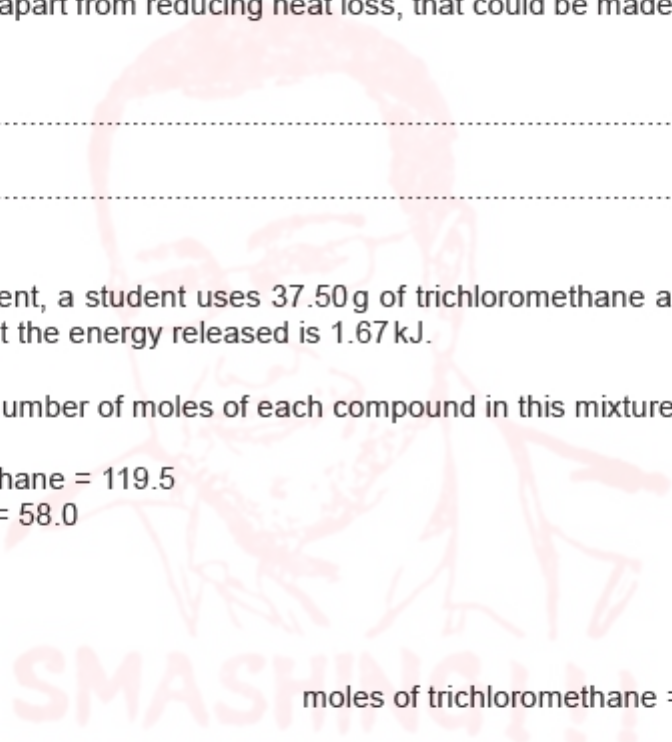

moles of trichloromethane = mol

moles of propanone = mol

[1]

(ii) Calculate the enthalpy change, ΔH , of the electrostatic attraction formed between trichloromethane and propanone. You must include a sign in your answer.

$\Delta H = \dots\dots\dots$ kJ mol⁻¹ [2]

- (f) Suggest an experiment the student could carry out to test whether the number of moles of trichloromethane affects the temperature change.

.....

.....

..... [1]

[Total: 11]



1 Zinc metal reacts with aqueous copper(II) sulfate.

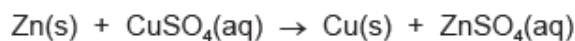

The enthalpy change of this reaction, ΔH , can be determined by adding excess zinc powder to a measured volume of $0.500 \text{ mol dm}^{-3}$ aqueous copper(II) sulfate.

The temperature of 25.0 cm^3 of $0.500 \text{ mol dm}^{-3}$ aqueous copper(II) sulfate is recorded for three minutes. At four minutes 3 g , an excess, of zinc powder is added and the mixture is continuously stirred. The temperature is recorded at times shown in the table.

time/min	0	1	2	3		$4\frac{1}{2}$	5	$5\frac{1}{2}$	6	$6\frac{1}{2}$	7	8	9	10
temperature / $^{\circ}\text{C}$	18	19.5	19.5	19.5		32.5	38	36	34	33	32.5	31.5	31	31

(a) Use the results table to deduce the graduations on the thermometer that is used to record these temperature readings.

..... [1]

(b) Draw a labelled diagram of the apparatus set up at one minute.

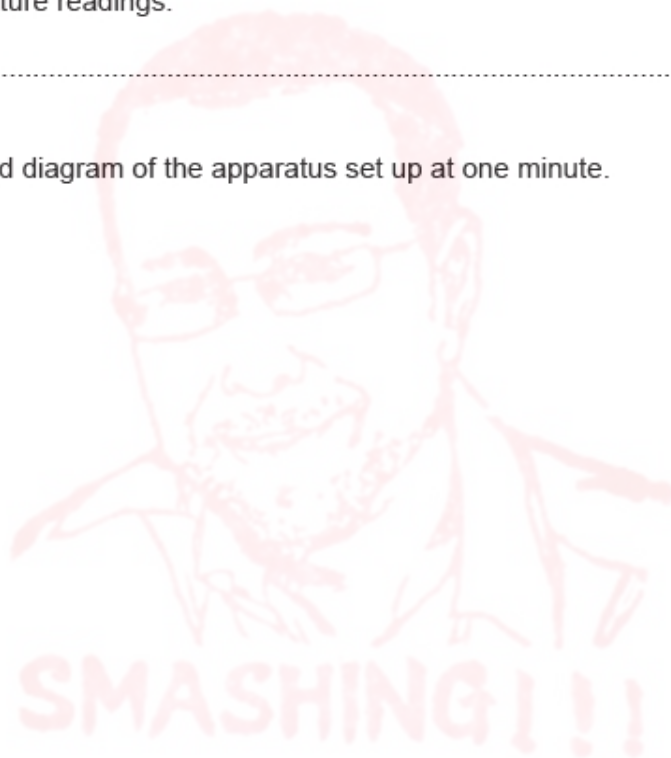

[2]

- (c) Plot a graph of temperature (y-axis) against time (x-axis). Use a cross (x) to plot each data point. Draw a line of best fit during cooling.

Extrapolate the cooling curve back to four minutes and determine the temperature change during the reaction.

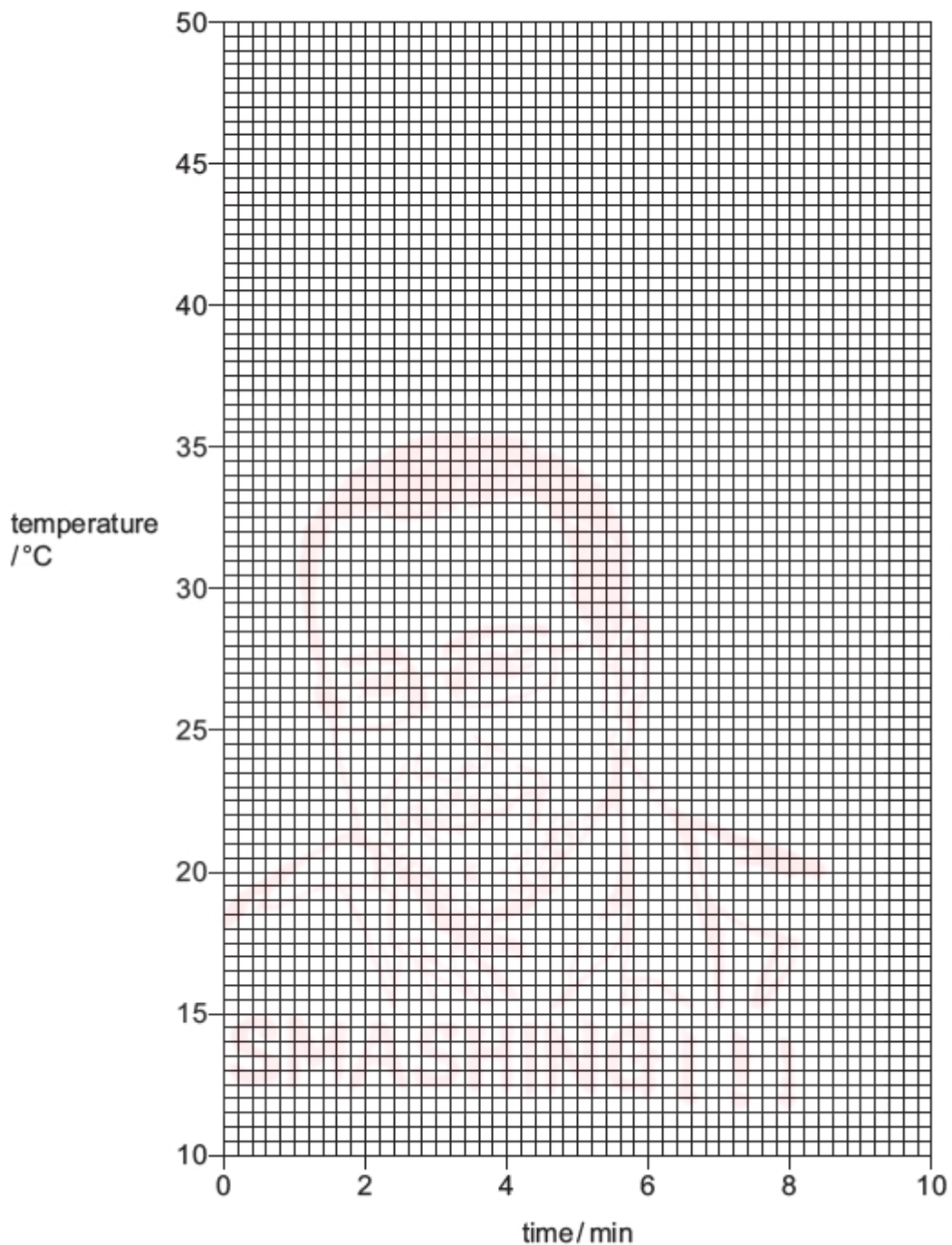

temperature change = °C [2]

(d) Use the formula $\Delta H = -mc\Delta T$ to determine the enthalpy change of reaction, ΔH , in kJ mol^{-1} .

Assume:

- mass of 1.00 cm^3 of solution = 1.00 g
- $c = 4.18 \text{ J g}^{-1} \text{ K}^{-1}$.

$\Delta H = \dots\dots\dots \text{ kJ mol}^{-1}$ [2]

(e) Heat loss is a major source of error in the results of this experiment.

Suggest how the following changes would affect the amount of heat loss, if at all.

Explain your answer in each case.

(i) The mass of zinc is doubled.

effect on heat loss

explanation

..... [1]

(ii) The concentration of 25.0 cm^3 of aqueous copper(II) sulfate is doubled. The amount of zinc used is still an excess.

effect on heat loss

explanation

..... [1]

(iii) The volume of $0.500 \text{ mol dm}^{-3}$ aqueous copper(II) sulfate is doubled. The amount of zinc used is still an excess.

effect on heat loss

explanation

..... [1]

[Total: 10]



- 1 The hydroxides of Group I metals (LiOH, NaOH, KOH, RbOH, CsOH) are highly corrosive white solids which rapidly absorb water vapour on exposure to the atmosphere. All of these solids dissolve exothermically in water. The enthalpy change of solution, ΔH_{soln} , is the energy change associated with the following reaction. *M* represents the Group I metal.

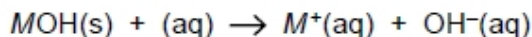

The following diagram represents theoretical stages in the formation of aqueous MOH.

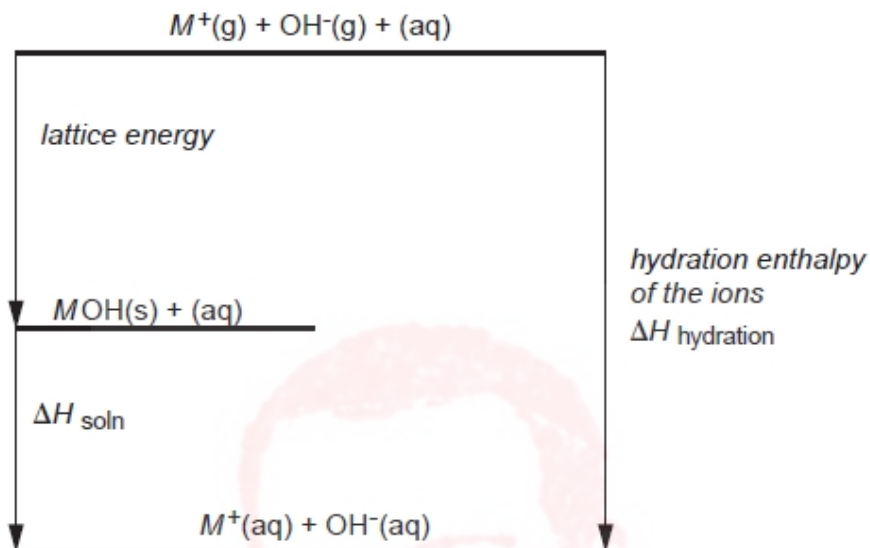

Lattice energy and hydration enthalpy are both more exothermic when ions carry a higher charge and/or ions have a smaller radius.

When comparing Group I hydroxides, changes in $\Delta H_{\text{hydration}}$ are more significant than changes in lattice energy.

- (a) By considering trends in the size and charge of the ions, predict the likely trend in ΔH_{soln} from LiOH to CsOH and sketch your prediction.

.....

.....

.....

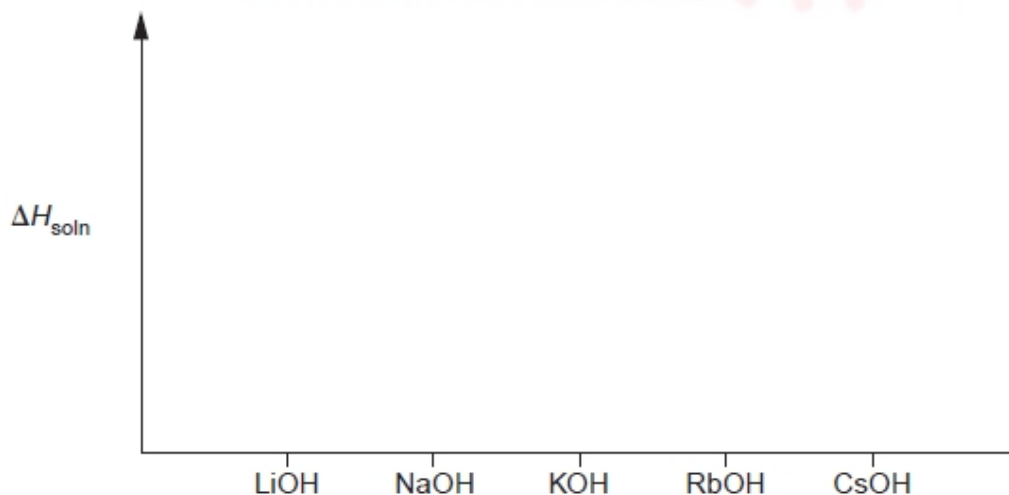

[2]



- (b) The enthalpy change of solution, ΔH_{soln} , for any Group I hydroxide can be measured experimentally in the laboratory.

In experiments to compare ΔH_{soln} for LiOH, NaOH, KOH, RbOH, CsOH state

the independent variable

the dependent variable

the other variable to be controlled

[3]

- (c) Draw a labelled diagram to show the apparatus you would use to obtain data from which ΔH_{soln} could be determined.

From the information given on page 2 and the apparatus you plan to use, identify **two** possible sources of error in the experiment and state how you would minimise the effect of each.

error 1

error 2

[3]

- (d) Identify a health and safety risk in the experiment and explain how you would minimise it when carrying out the experiment.

.....

.....

..... [2]

- (f) The procedure is repeated for each of the Group I hydroxides.
Show how you would tabulate the results for **all** the experiments.

[1]

- (g) Show how you would use the results of **one** experiment to calculate the enthalpy change of solution, ΔH_{soln} , for the reaction.

[1]

[Total: 16]



- 1 When potassium nitrate dissolves in water, the temperature of the solution goes down because the enthalpy of solution is endothermic.

You are to plan an experiment to investigate how the solubility of potassium nitrate varies with temperature. The units of solubility are grams per one hundred grams of water (g/100g water).

- (a) (i) Predict how the solubility of potassium nitrate will change if the solution temperature is **increased**.

Explain your prediction using the fact that dissolving potassium nitrate is endothermic.

prediction

.....

explanation

.....

.....

.....

- (ii) Display your prediction in the form of a sketch graph, labelling clearly the axes.



[3]

- (b) In the experiment you are about to plan, identify the following.

(i) the independent variable

(ii) the dependent variable

[2]



- (d) State a hazard that must be considered when planning the experiment and describe precautions that should be taken to keep risks to a minimum.

.....
..... [1]

- (e) Draw a table with appropriate headings to show the data you would record when carrying out your experiments and the values you would calculate in order to construct a graph to support or reject your prediction in (a). The headings **must** include the appropriate units.



[2]

[Total: 15]



1 Ammonium nitrate, NH_4NO_3 , is soluble in water (approximately 2.5 mol/100 g at 25 °C). The molar enthalpy of solution of a solid is defined as the enthalpy change when one mole of the solid is dissolved in water.

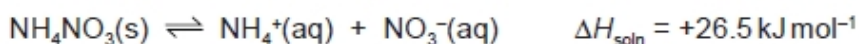

(a) (i) Predict how the temperature of water, initially at 25 °C, would change as ammonium nitrate is dissolved. Explain this prediction in terms of lattice energy and the enthalpy of hydration of ions.

Prediction of the temperature change

.....

.....

Explanation

.....

.....

.....

(ii) In the space below, sketch a graph to show your prediction of temperature change with concentration. Use two labelled axes and include an origin.

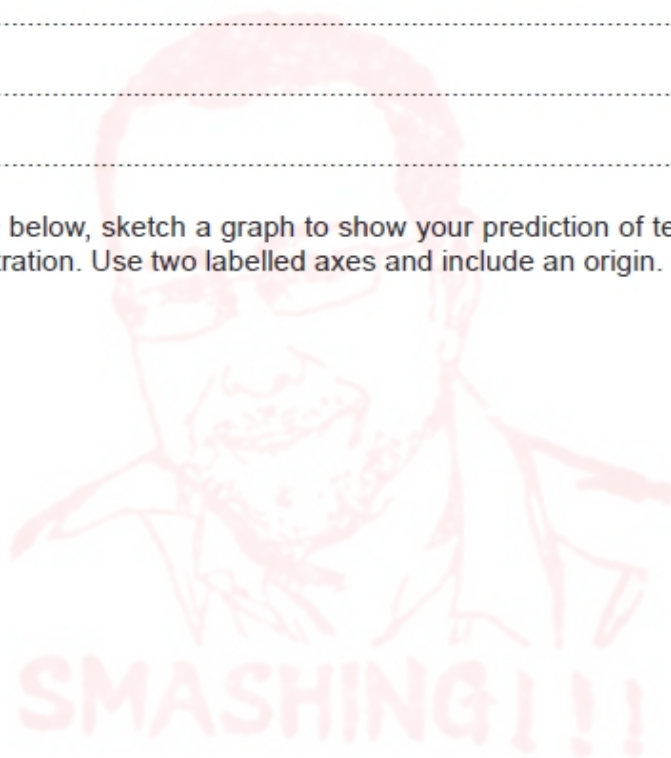

[4]

(b) If you were to carry out an experiment to investigate how the **temperature change** of the solution varies as the **concentration changes** name,

(i) the independent variable,

(ii) the dependent variable.

[1]

- (c) You are to plan an experiment to determine as accurately as possible how the temperature change varies when different solutions are made, each with different concentrations of ammonium nitrate. You are reminded that the approximate solubility of ammonium nitrate is 2.5 mol/100 g at 25 °C.

The following information gives some of the hazards associated with ammonium nitrate.

Ammonium nitrate NH_4NO_3 . Contact with combustible material may cause fire. Explosive when mixed with combustible material.

Do not allow the salt to become contaminated with organic matter and do not grind it.

Solutions should be diluted to less than 0.5 mol dm^{-3} for disposal.

You should use only standard apparatus found in a school or college laboratory. Draw a diagram of the apparatus and experimental set up you would use showing clearly the following:

- (i) the apparatus used, such as the reaction vessel, and how the thermometer will be positioned in order to measure the temperature of the solution as accurately as possible,
- (ii) how the apparatus will be insulated.

Label each piece of apparatus used, indicating its size or capacity and both the temperature range and the precision of the thermometer.

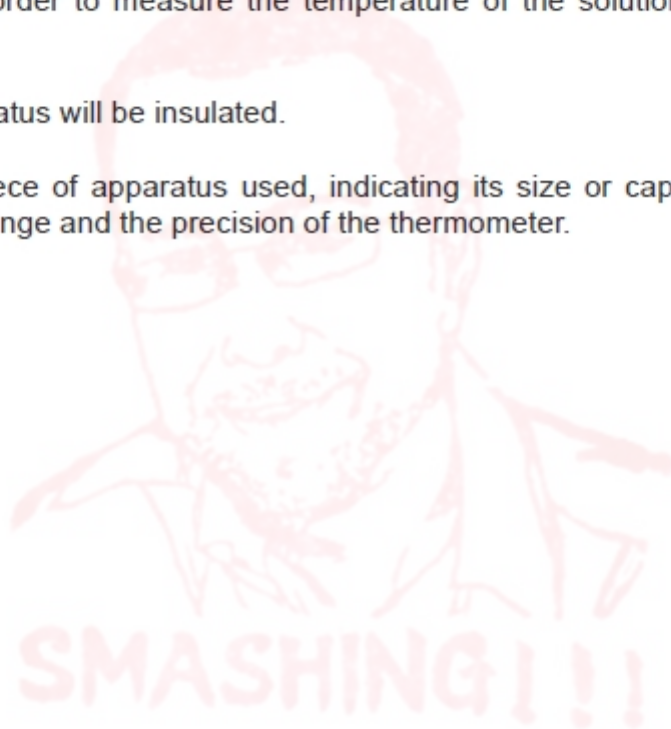

[3]

- (d) Using the apparatus shown in (c) design an experiment to test your prediction in (a)(ii) of how the temperature change of the solution varies with solutions of different concentration.

In addition to the apparatus normally found in a laboratory you are provided with the following materials;

a supply of solid ammonium nitrate,
distilled (deionised) water.

Give a step-by-step description of how you would carry out the experiment to include;

- (i) the number of experiments you would do,
- (ii) the temperature measurements you would take,
- (iii) the volume of water you would use,
- (iv) a calculation to show the maximum mass of ammonium nitrate you could use for your volume of water in (iii) and a range of masses for the other experiments.

[A_r: H, 1.0; N, 14.0; O, 16.0]



[4]

- (e) State one hazard that must be considered when planning the experiment and describe a precaution that should be taken to keep risks from this hazard to a minimum. You may use the information in (c) if you wish.

.....

.....

.....

.....

.....

.....

..... [1]

- (f) In order to test your prediction in (a)(ii), you would need to plot a graph. In the space below, draw a table with appropriate headings, in which you would record all your experimental data and calculated values necessary for the construction of the graph. The headings **must** include the appropriate units.



[2]

[Total: 15]



1 Potassium hydrogencarbonate, KHCO_3 , decomposes when strongly heated to form potassium carbonate, K_2CO_3 .

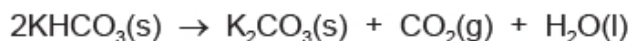

A student plans to determine the value for the enthalpy change for this reaction, ΔH_r , which cannot be determined directly. The student carries out two separate experiments using the following apparatus.

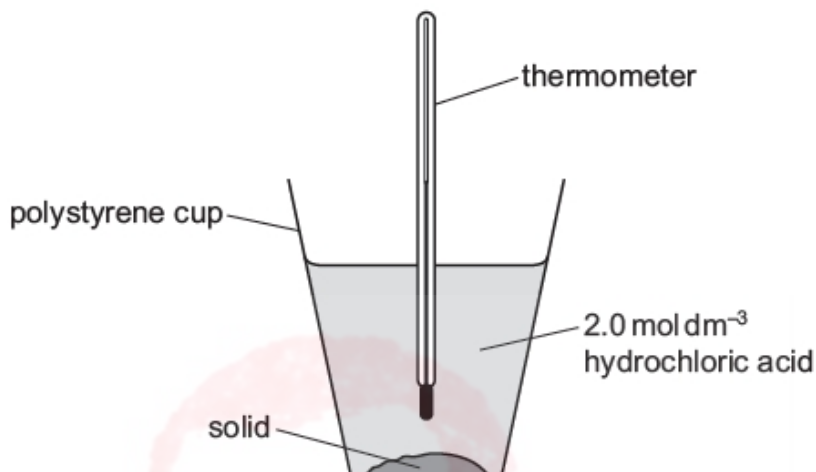

Experiment 1 uses solid KHCO_3 .

Experiment 2 uses solid K_2CO_3 .

The following method is used for both experiments:

- Transfer 50.00 cm^3 , an excess, of 2 mol dm^{-3} hydrochloric acid into a cup.
- After 2 minutes, record the temperature of the acid.
- Weigh approximately 0.0250 moles of solid.
- Add the solid to the acid, stir the mixture using a thermometer and record the temperature throughout the reaction.

Hazard information: 2 mol dm^{-3} hydrochloric acid is irritant, solid potassium hydrogencarbonate and solid potassium carbonate may cause irritation to the skin and eyes.

The equations for the two reactions are:

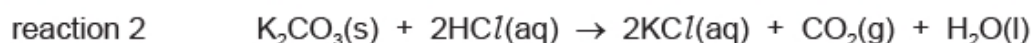
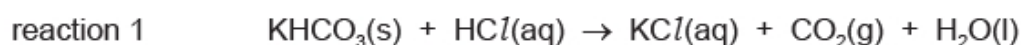

(a) Suggest why it is not possible to measure ΔH_r for the decomposition reaction directly.

.....
 [1]

- (b) (i) Calculate the mass of 0.0250 moles of each solid. Give your answers to **three** decimal places.

[A_r : K, 39.1; H, 1.0; C, 12.0; O, 16.0]

mass of KHCO_3 = g

mass of K_2CO_3 = g
[1]

- (ii) The masses of solid are measured using a three decimal place balance.

Calculate the percentage error in the measurement of the mass of KHCO_3 .

Show your working.

percentage error = [1]

- (c) The student obtained the following results.

solid	initial temperature / °C	maximum / minimum temperature / °C	temperature change, ΔT / °C
KHCO_3	17.5	14.0	
K_2CO_3	19.0	20.5	

- (i) Complete the table by calculating temperature change.

Use the formula $q = mc\Delta T$ to determine the energy change, q , that took place during **experiment 1**. Use q to calculate the enthalpy change of reaction 1, ΔH_1 , in kJ mol^{-1} .

Include a sign in your answer.

Assume 1.00 cm^3 of solution has a mass of 1.00 g.
 $c = 4.18 \text{ J g}^{-1} \text{ K}^{-1}$

$\Delta H_1 =$ kJ mol^{-1} [2]



- (ii) Use the formula $q = mc\Delta T$ to determine the energy change, q , that took place during **experiment 2**. Use q to calculate the enthalpy change of reaction 2, ΔH_2 , in kJ mol^{-1} .

Include a sign in your answer.

Assume 1.00 cm^3 of solution has a mass of 1.00 g .

$c = 4.18 \text{ J g}^{-1} \text{ K}^{-1}$

$\Delta H_2 = \dots\dots\dots \text{ kJ mol}^{-1}$ [2]

- (d) Use the following cycle to calculate ΔH_r .

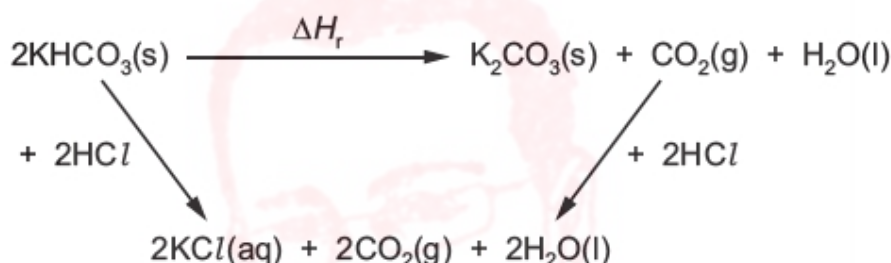

$\Delta H_r = \dots\dots\dots \text{ kJ mol}^{-1}$ [2]

- (e) A textbook states the value of the enthalpy change for the decomposition of potassium hydrogencarbonate as $+76.0 \text{ kJ mol}^{-1}$.

Suggest **two** reasons why the experimental value is different to the actual value.

1

2

[2]

- (f) Suggest **one** improvement to the apparatus which would reduce the difference between the experimental value and the actual value.

..... [1]



(g) Name a suitable piece of apparatus which should be used to measure the volume of acid used in **experiment 1**.

..... [1]

(h) Apart from wearing safety glasses and a lab coat, state **one** safety precaution which must be taken during **experiment 1**. Explain your answer.

.....

.....

..... [1]

[Total: 14]



Miscellaneous

Topic Chem 2 Miscellaneous Q# 86/ ALvl Chemistry/2017/s/TZ 1/ Paper 5/Q# 2/www.SmashingScience.org

- 2** Sucrose is a sugar. The concentration of a solution of sucrose can be measured by the optical rotation, α , of a sucrose solution. The more concentrated the solution, the greater the optical rotation of the solution.

A polarimeter is used to measure optical rotation. Light is passed through a sample of the sucrose solution in a glass cell, and the observed angle of rotation, α_{obs} , is measured.

A simplified diagram of a polarimeter is shown.

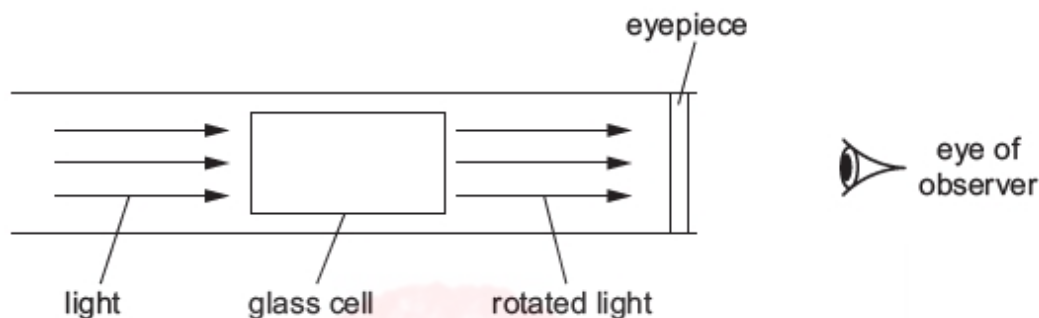

If a glass cell of length 10 cm is filled with a solution of sucrose of concentration 1 g cm^{-3} the measured angle of rotation is known as the specific rotation, $[\alpha]$.

The observed angle of rotation, α_{obs} , measured by the polarimeter is related mathematically to the concentration of the sucrose solution by the equation shown.

$$\alpha_{\text{obs}} = [\alpha]c$$

α_{obs} is the observed angle of rotation using a 10 cm cell

$[\alpha]$ is the specific rotation of sucrose solution

c is the concentration of sucrose, in g cm^{-3}

A student wanted to determine the specific rotation of sucrose, $[\alpha]$. Solutions of different concentrations of sucrose at 20°C were placed in a polarimeter and the observed angle of rotation, α_{obs} , recorded. The '+' sign is used to show that the rotation is in a clockwise direction.

concentration of sucrose, c / g cm^{-3}	observed angle of rotation, α_{obs}
0.0750	+5.05
0.0700	+4.70
0.0650	+4.40
0.0600	+4.00
0.0500	+3.30
0.0450	+2.55
0.0350	+2.30
0.0300	+1.95
0.0250	+1.68
0.0200	+1.40

- (a) (i) Plot a graph on the grid on page 9 to show the relationship between concentration of sucrose, c , and observed angle of rotation, α_{obs} .
Use a cross (x) to plot each data point. Draw a line of best fit. [2]
- (ii) Circle the most anomalous point on your graph. [1]
- (iii) Use the graph to determine the specific rotation, $[\alpha]$, of sucrose.
Give this value to **two decimal places**.
State the co-ordinates of both points you used in your calculation.

co-ordinates 1 co-ordinates 2

specific rotation of sucrose, $[\alpha] =$ [2]

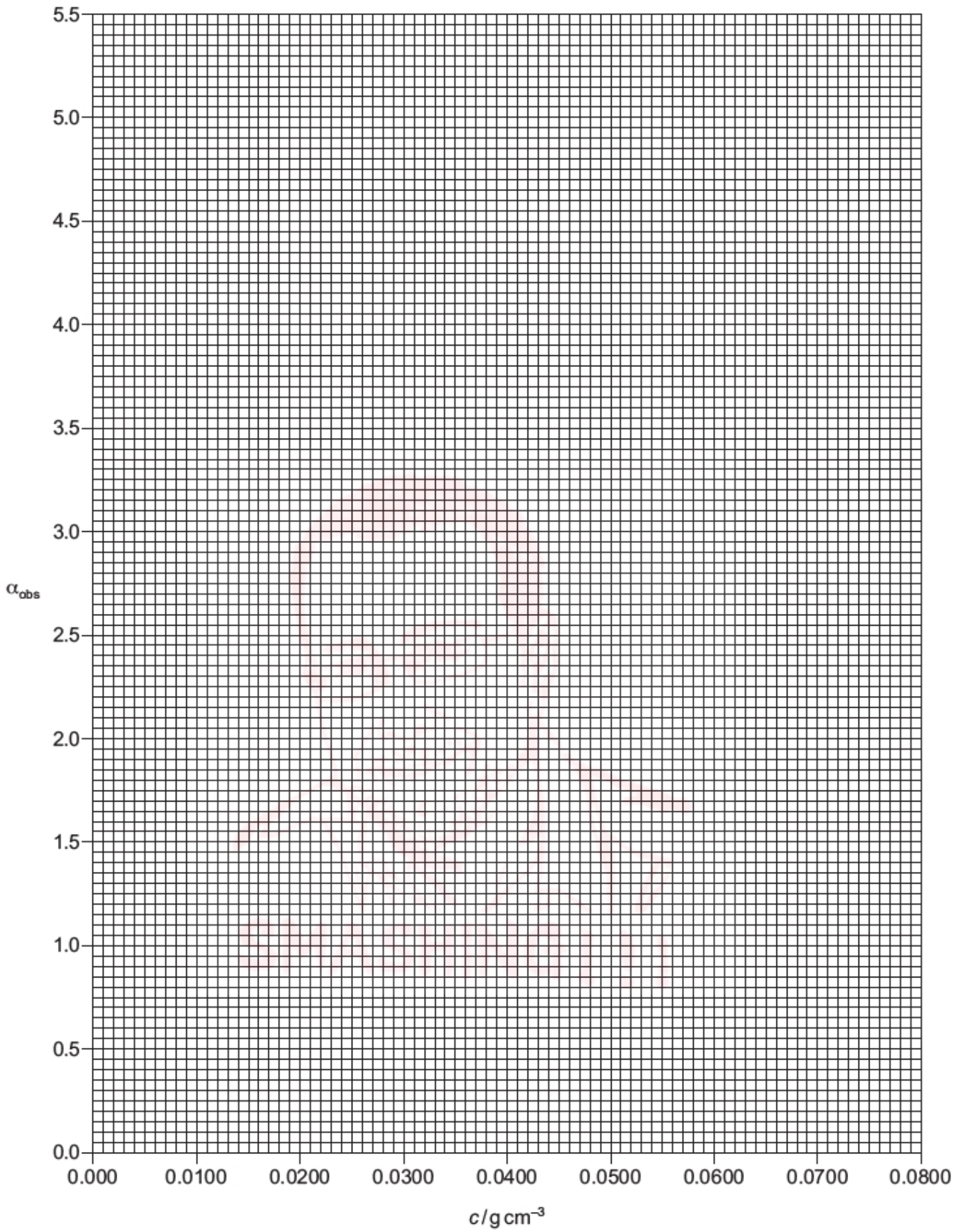

(b) You are asked to write instructions for another student to follow so they can prepare a standard solution of 250 cm^3 0.0750 g cm^{-3} sucrose. The student is provided with solid sucrose and a 250 cm^3 volumetric flask.

(i) Calculate the mass, in g, of sucrose the student would need to use.

mass of sucrose = g [1]

(ii) Describe how the student should accurately prepare the standard solution using a sample of sucrose of mass calculated in **(i)**.

.....

.....

.....

.....

.....

.....

..... [2]

(c) (i) The student used the standard solution prepared in **(b)** to prepare the solutions in the table on page 8.

Calculate the volume of standard solution of concentration 0.0750 g cm^{-3} and the volume of distilled water needed to prepare 15.00 cm^3 of sucrose solution of concentration 0.0350 g cm^{-3} .

Give your answers to **two** decimal places.

volume of standard solution = cm^3

volume of distilled water = cm^3
[1]



The volumes of the two solutions given in **(c)(i)** could be measured using the same type of apparatus.

(ii) Name a suitable piece of apparatus which could be used to measure these volumes.

..... [1]

(iii) In **(a)(ii)** you circled an anomalous point. This was caused by the student incorrectly making one of the sucrose solutions.

Suggest the error made by the student that caused this anomaly.

.....
.....
..... [1]

(d) The student recorded the observed angle of rotation, α_{obs} , for a sucrose solution of unknown concentration as +3.75.

Determine the concentration of this sucrose solution in mol dm^{-3} .

[M_r , sucrose: 342]

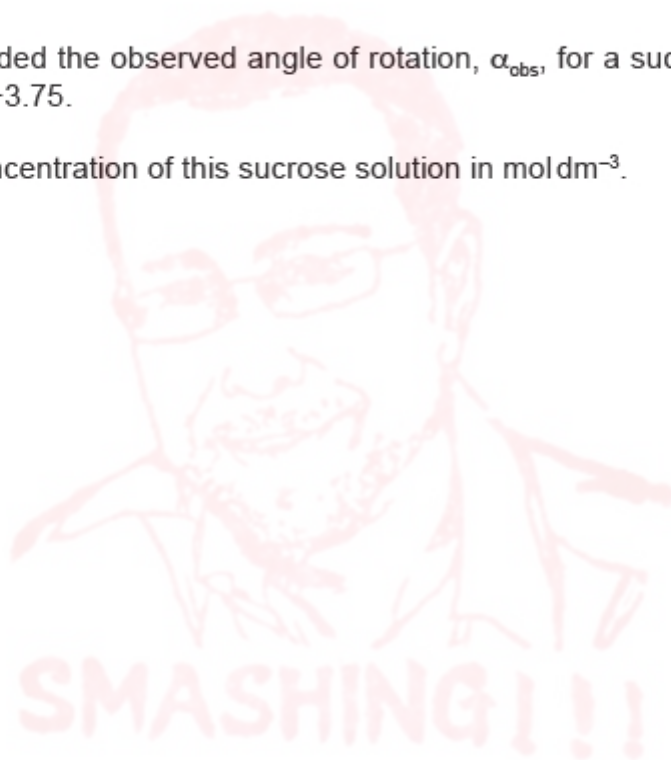

concentration of sucrose = mol dm^{-3} [3]

- (e) The glass cell of 10 cm length is expensive, so one cell is used for all the solutions that are placed in the polarimeter.

Suggest how you would ensure that the concentration of solution in the cell is accurate **each time** the cell is used for the different sucrose solutions.

.....
.....
..... [1]

- (f) Concentration of sucrose is the independent variable in this polarimeter experiment.

The glass cell of 10 cm length is replaced by a glass cell of 20 cm length. The 20 cm glass cell is filled with 0.0750 g cm^{-3} sucrose solution.

Predict the value for the observed angle of rotation, α_{obs} , for the sucrose solution of concentration 0.0750 g cm^{-3} when the 20 cm cell is used. Explain your answer.

predicted value =

explanation

..... [2]

- (g) Before the angles of rotation of the sucrose solutions are measured, the glass cell is first filled with distilled water and the angle of rotation measured.

Explain why this measurement is taken.

.....
..... [1]

[Total: 18]

- 2** Transition metal complex ions are coloured. The formula of a complex ion can be determined using colorimetry.

In colorimetry, light of a certain wavelength is passed through a complex ion solution. The absorbance of the light is proportional to the intensity of the colour of the solution. The more concentrated the complex ion solution, the more intense its colour and so the higher the absorbance.

A student carried out an experiment to determine the formula of the complex ion formed between aqueous iron(III) ions, $\text{Fe}^{3+}(\text{aq})$, and aqueous 2-hydroxybenzoate ions, $\text{C}_6\text{H}_4(\text{OH})\text{CO}_2^-$, which have the structure shown.

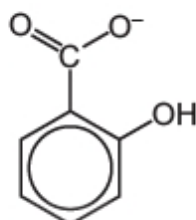

- (a)** In the first step of the experiment the student prepared 100.0 cm^3 of $0.0500 \text{ mol dm}^{-3}$ aqueous iron(III) nitrate.
- (i)** Determine the mass, in g, of solid hydrated iron(III) nitrate, $\text{Fe}(\text{NO}_3)_3 \cdot 9\text{H}_2\text{O}$, needed to prepare 100.0 cm^3 of a $0.0500 \text{ mol dm}^{-3}$ solution.
 [A_r : Fe, 55.8; N, 14.0; O, 16.0; H, 1.0]

mass of $\text{Fe}(\text{NO}_3)_3 \cdot 9\text{H}_2\text{O}$ = g [2]

- (ii)** Describe how, after weighing the mass determined in **(i)**, the student should prepare 100.0 cm^3 of $0.0500 \text{ mol dm}^{-3}$ aqueous iron(III) nitrate.

In your answer you must give the name and capacity, in cm^3 , of any apparatus used.

.....

.....

.....

.....

..... [2]

- (b) The student prepared solutions containing various combinations of $0.0500 \text{ mol dm}^{-3} \text{ Fe}^{3+}(\text{aq})$ and $0.0500 \text{ mol dm}^{-3}$ aqueous 2-hydroxybenzoate, as shown in the table.

The student placed a small sample of each solution into a colorimeter and measured the absorbance. The student made a mistake in test number **9** and did **not** measure the result.

test number	1	2	3	4	5	6	7	8	9	10	11
volume of $\text{Fe}^{3+}(\text{aq})/\text{cm}^3$	0.0	1.0	2.0	3.0	4.0	5.0	6.0	7.0		9.0	10.0
volume of aqueous 2-hydroxybenzoate / cm^3	10.0	9.0	8.0	7.0	6.0	5.0	4.0	3.0		1.0	0.0
absorbance	0	23	46	69	70	58	47	35		13	0

- (i) Plot a graph on the grid to show the relationship between absorbance and the volumes of $\text{Fe}^{3+}(\text{aq})$ and aqueous 2-hydroxybenzoate used.

Use a cross (x) to represent each data point. Draw **two** lines of best fit.

[2]

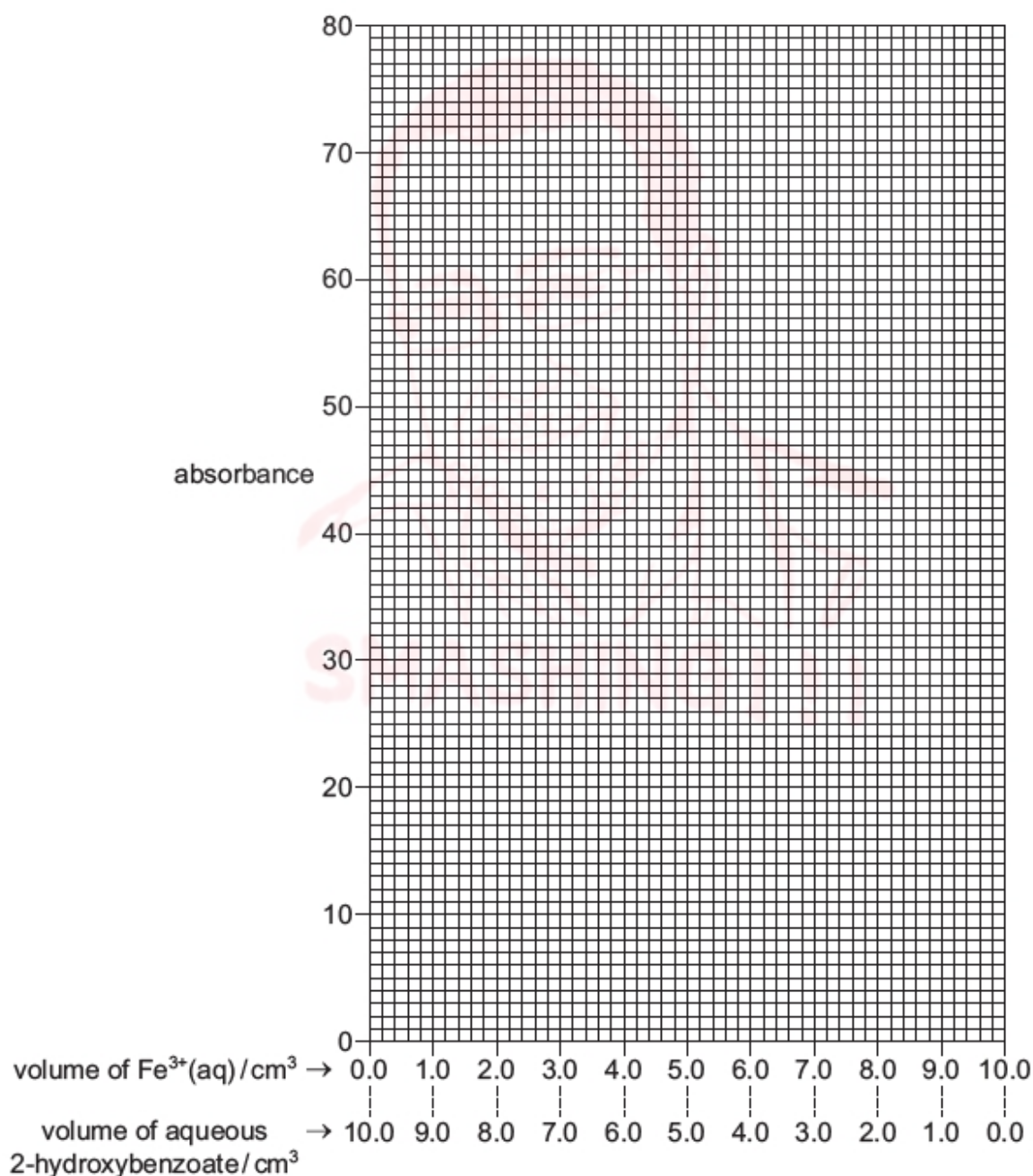

- (ii) Use the graph in (i) to determine the volumes of $\text{Fe}^{3+}(\text{aq})$ and aqueous 2-hydroxybenzoate which would give the maximum absorbance.

volume of $\text{Fe}^{3+}(\text{aq})$ = cm^3

volume of aqueous 2-hydroxybenzoate = cm^3
[1]

- (iii) The point of maximum absorbance shows where all of the ions are combined in the complex.

Use the volumes in (ii) to determine the number of moles of 2-hydroxybenzoate ions that form a complex with 1 mole of Fe^{3+} ions.

moles of 2-hydroxybenzoate ions = [1]

- (iv) $\text{Fe}^{3+}(\text{aq})$ ions exist in aqueous solution as complex ions with the formula $[\text{Fe}(\text{H}_2\text{O})_6]^{3+}(\text{aq})$. 2-hydroxybenzoate ions, $\text{C}_6\text{H}_4(\text{OH})\text{CO}_2^-$, are bidentate ligands.

Use this information and your answer to (iii) to suggest the formula of the complex ion formed between $\text{Fe}^{3+}(\text{aq})$ ions and 2-hydroxybenzoate ions.

..... [1]

- (v) Name the apparatus that should be used to measure the volumes of the solutions given in the table accurately.

..... [1]

- (c) In test 9, instead of mixing 8.0 cm³ of Fe³⁺(aq) and 2.0 cm³ of aqueous 2-hydroxybenzoate, the student mixed 16.0 cm³ of Fe³⁺(aq) and 4.0 cm³ of aqueous 2-hydroxybenzoate.

Use your graph in (b)(i) to suggest the absorbance that would have been measured if a sample of this solution had been analysed in the colorimeter.

absorbance = % [1]

- (d) In a colorimetry experiment, the absorbance of the solution follows the relationship shown.

$$A = \epsilon cl$$

A is the absorbance (no units).

c is the concentration in mol dm⁻³.

l is the path length of the light travelling through the solution in cm.

ϵ is the molar absorption coefficient (a constant).

Determine the unit of ϵ .

unit = [1]

[Total: 12]

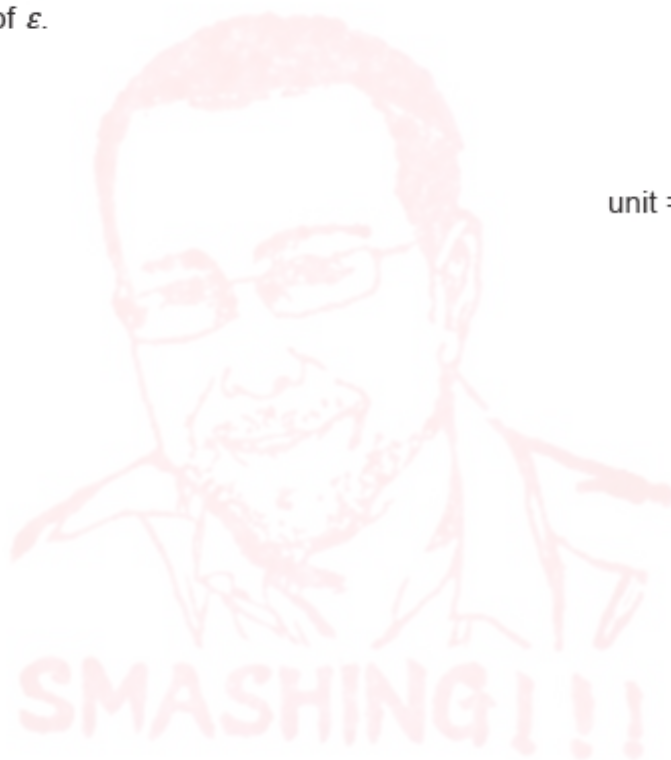

2 ASSESSMENT OF PLANNING SKILLS

Copper carbonate

decomposes on strong heating,

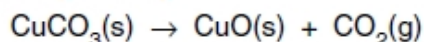

reacts with hydrochloric acid.

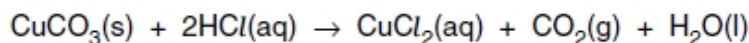

Carbon dioxide, CO_2 , is an acidic oxide.

Copper oxide, CuO , is a basic oxide.

Malachite is a rock containing a high percentage of copper carbonate. You are to plan an experiment to determine the % of copper carbonate in a specimen of malachite. In your plan you may use any equipment normally found in a school laboratory.

You may assume that any other material present in the malachite is unaffected by heating and is neither acidic or basic.

In your plan you must include masses, volumes, concentrations of materials used as appropriate.

You will need to use some or all of the following information.

[Cu, 63.5; C, 12.0; O, 16.0.]

1 mole of any gas occupies a volume of approximately 24.0 dm^3 at room temperature and pressure.

DO NOT CARRY OUT YOUR PLAN

Plan

.....

.....

.....

.....

.....

.....

.....

.....

.....

.....

a	
b	
c	
d	

[4]



EXPERIMENT Required, no longer needed from 2007 onwards.

- 1 **FB 1** is 2.00 mol dm^{-3} hydrochloric acid, HCl .
FB 2 is a solid carbonate, X_2CO_3 in a stoppered tube.
FB 2 reacts with hydrochloric acid as shown in the equation below.

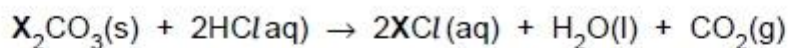

You are to determine the mass of carbon dioxide evolved in the reaction of the carbonate **FB2** with excess hydrochloric acid and to calculate from the results of the experiment the relative atomic mass, A_r , of **X**.

- (a) Use a measuring cylinder to place 100 cm^3 of **FB 1** into a 250 cm^3 conical flask. Weigh the flask and acid. Record the mass in Table 1.2.

Weigh the stoppered tube containing **FB 2**. Record the mass in Table 1.1.

Add the weighed **FB 2**, **a little at a time** with swirling, to the acid in the conical flask. **N.B.** Take care to avoid excessive bubbling and loss of acid as 'spray'.

When all of the **FB 2** has been added from the tube, reweigh the empty tube (with its stopper) and record the mass in Table 1.1.

Leave the flask to stand for 2-3 minutes and then reweigh the flask and solution. Record the mass in Table 1.2.

mass of stoppered tube + FB 2	/g	
mass of empty tube + stopper	/g	

Table 1.1

mass of flask + acid	/g	
mass of flask + solution after the reaction	/g	

Table 1.2

[3]

- (b) Calculate the mass of **FB 2** used.

..... g [1]

- (c) Calculate the mass of carbon dioxide evolved.

..... g [1]

- (d) Use your answer to (c) and the equation for the reaction to calculate the number of moles of X_2CO_3 that reacted.
[A_r : C, 12.0; O, 16.0.]

..... moles [1]

- (e) Calculate the relative molecular mass, M_r , of X_2CO_3 .

$M_r = \dots\dots\dots$ [1]

- (f) Calculate the relative atomic mass, A_r , of X.
[A_r : C, 12.0; O, 16.0.]

$A_r = \dots\dots\dots$ [1]

[Total : 8]

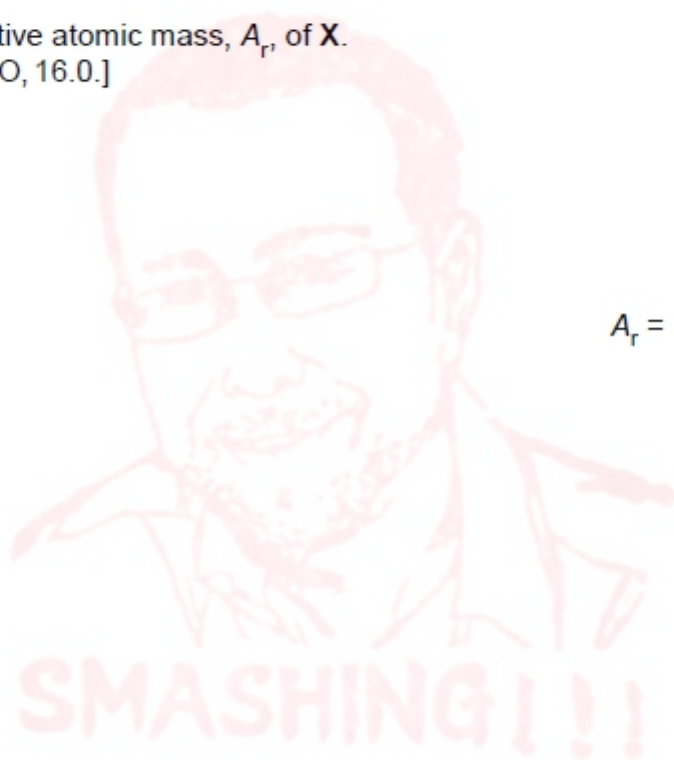

2 Basic copper(II) carbonate is a mixture of copper(II) carbonate and copper(II) hydroxide with varying amounts of water of crystallisation.

The formula may be represented as $\text{CuCO}_3 \cdot \text{Cu}(\text{OH})_2 \cdot x\text{H}_2\text{O}$.

A group of students conduct an experiment to determine the relative formula mass and the actual value of x in the formula of the basic copper(II) carbonate, $\text{CuCO}_3 \cdot \text{Cu}(\text{OH})_2 \cdot x\text{H}_2\text{O}$.

This basic carbonate decomposes on heating.

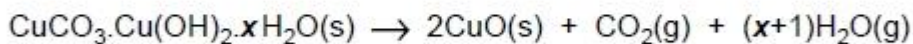

Each student is provided with a sample of the solid basic carbonate and the following apparatus.

- a boiling-tube
- a test-tube holder
- a chemical balance, reading to 2 decimal places
- a Bunsen burner

Method

- The empty boiling-tube is weighed.
- The sample of basic copper(II) carbonate is tipped into the boiling-tube which is reweighed.
- The carbonate is heated, gently at first, as carbon dioxide and water vapour are given off. The carbonate is then heated strongly.
- Heating is continued until all of the green colour of the initial solid has turned to the black colour of copper(II) oxide.
- The apparatus is cooled and the mass of the tube and residue is measured.

The results of the experiment are recorded below.

	A	B	C	D	E	F
student	mass of empty boiling-tube /g	mass of boiling-tube and basic carbonate before heating /g	mass of boiling-tube and residue after heating /g			
1	10.32	11.19	10.92			
2	10.05	11.56	11.09			
3	10.11	12.33	11.24			
4	9.94	12.39	11.62			
5	9.99	13.73	12.56			
6	10.23	14.68	13.28			
7	10.01	15.19	13.56			
8	9.87	15.80	13.97			
9	9.96	16.62	14.66			
10	9.84	17.83	15.46			

- (a) Use the additional columns of the table to record the calculated values that will enable you to determine the relative formula mass, M_r , of basic copper(II) carbonate and the value of x in $\text{CuCO}_3 \cdot \text{Cu}(\text{OH})_2 \cdot x\text{H}_2\text{O}$.

You may use some or all of the columns. Label the columns you use, including the units and an equation to show how the value is calculated. You may use the column headings A to F in the equations e.g. C – B.

Make certain that your processed values show the precision of the apparatus used. [2]

(b) Present the values calculated in (a) in graphical form. Draw the line of best-fit.

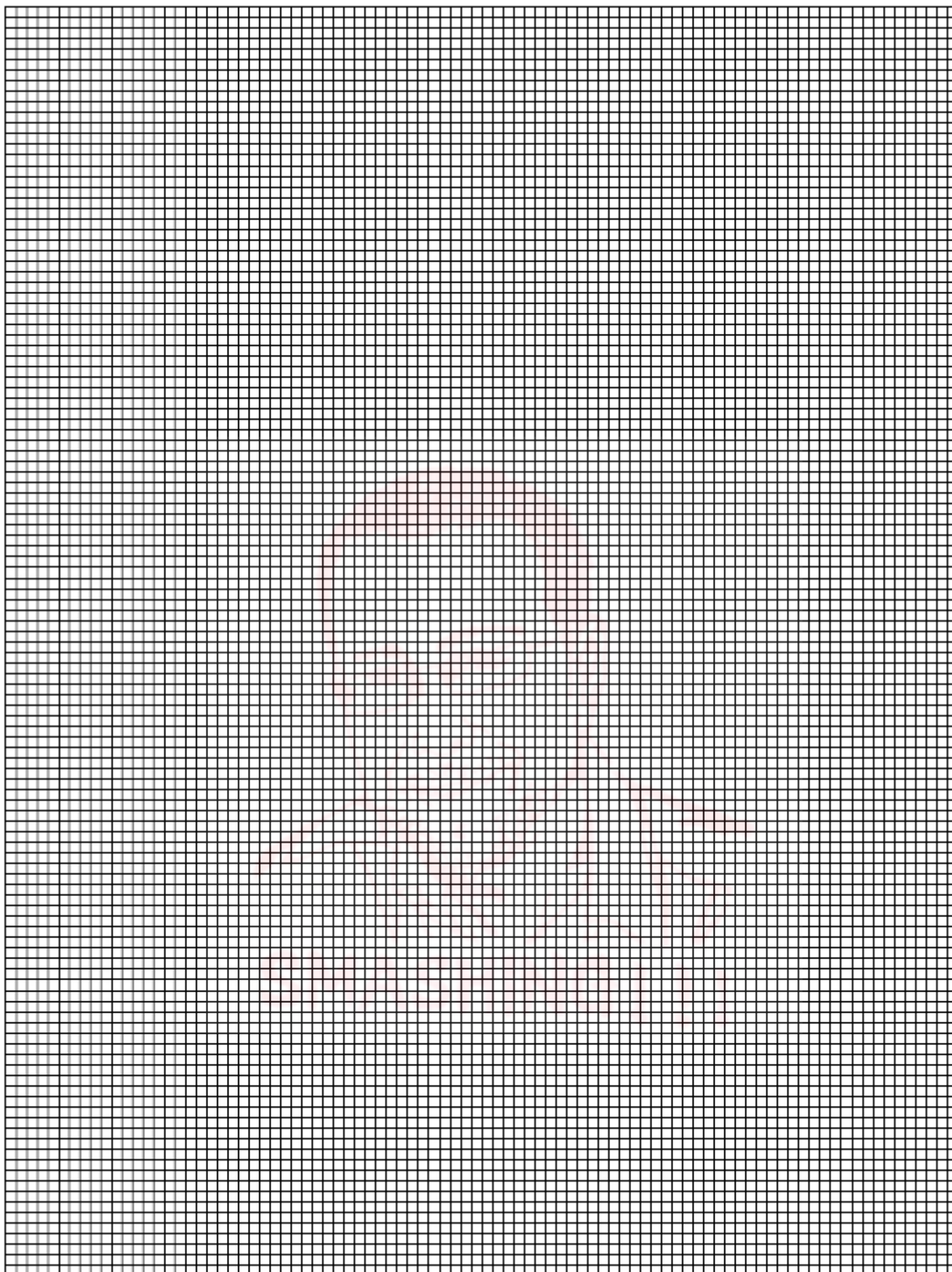

[4]

- (c) Give the co-ordinates of the **most significant** anomalous point.
By reference to the instructions for the experiment suggest an explanation for this anomaly.

co-ordinates

explanation

.....

..... [2]

- (d) The students note that points plotted when using higher masses of the basic carbonate lie to one side of the line of best-fit.

Suggest an explanation for this observation.

.....

.....

..... [1]

- (e) How would you modify the experiment to overcome the problem described in (d)?

.....

.....

..... [1]

- (f) Draw construction lines on the graph to derive values to enable you to calculate the relative formula mass of the basic copper(II) carbonate and the value of x in $\text{CuCO}_3 \cdot \text{Cu}(\text{OH})_2 \cdot x\text{H}_2\text{O}$.

Values read from graph, including units

x-axis y-axis

Calculation of the relative formula mass, M_r
[A_r : H, 1.0; C, 12.0; O, 16.0; Cu, 63.5]

- 2 A group of twelve students carried out the following experiment to confirm the formula of zinc iodide as ZnI_2 . In the experiment an **excess** of powdered zinc reacts with a solution of iodine in ethanol.

The instructions for the experiment given to each student are as follows.

- Weigh a dry, hard-glass test-tube.
- Put approximately 0.5 g of zinc powder in the test-tube and reweigh the tube.
- Add approximately 1.0 g of iodine and weigh the tube again.
- Cautiously add ethanol, drop by drop, until no further visible reaction takes place, and then add a further 1 cm^3 of ethanol, an excess.
- Shake the tube gently until the brown colour of the dissolved iodine disappears. This indicates that the reaction is complete.
- Place the tube in a centrifuge and spin the tube and its contents for 30 seconds. The excess zinc will “pack” at the bottom of the tube.
- Pour off and discard the liquid above the layer of zinc. This liquid contains the zinc iodide formed in the reaction.
- Wash the zinc powder with 1 cm^3 of ethanol.
- Centrifuge the tube and pour off the liquid as before.
- Repeat the washing of the zinc several times to remove any remaining traces of zinc iodide.
- Dry the tube and its contents by laying the tube on a gauze, on top of a tripod, **gently** heated by a small Bunsen burner flame.
- Allow the tube to cool and reweigh the tube and its contents.

- (a) The results of the experiment are shown in the table at the top of the next page.

Process the results in the table to produce values that will enable you to calculate the number of moles of zinc and iodine **reacting** in each student's experiment.

Record these values in the additional columns of the table. You may use some or all of the columns.

Label the columns you use. For each column, include the units and an expression to show how your values are calculated. You may use the column headings **A** to **G** in the expressions e.g. **C – B**.

You are reminded that an excess of zinc was used in each experiment.

Results

	A	B	C	D	E	F	G
student	mass of empty test-tube /g	mass of test-tube and zinc powder /g	mass of test-tube, zinc powder and iodine /g	mass of test-tube + excess of zinc /g			
1	15.60	16.13	17.13	15.87			
2	14.73	15.24	16.23	14.99			
3	13.81	14.29	15.32	14.07			
4	16.67	17.16	18.17	16.90			
5	15.89	16.40	17.38	16.15			
6	16.32	16.84	17.79	16.60			
7	13.11	13.58	14.55	13.33			
8	17.86	18.35	19.39	18.05			
9	16.45	16.95	17.97	16.69			
10	15.77	16.31	17.27	16.06			
11	12.99	13.47	14.52	13.20			
12	14.48	14.98	16.02	14.71			

[3]

- (b) (i) For each student calculate the number of moles of iodine atoms and number of moles of zinc that react together.
[A_r: I, 127; Zn, 65.4]

student	moles of iodine	moles of zinc	
1			
2			
3			
4			
5			
6			
7			
8			
9			
10			
11			
12			

- (ii) Process the values from (i) to enable you to confirm or reject the suggested formula of zinc iodide, ZnI₂. Use the blank column in the table above to record your results.

[4]

(c) By inspection of the values in (b), identify any student(s) whose experimental results you consider to be anomalous.

.....
..... [1]

(d) In the light of your answer to (c) explain how you would process the values from (b) to find the formula of zinc iodide.

[2]

(e) For each anomalous result identified in (c) refer to the instructions for the experiment and suggest a possible reason for the anomaly.

.....
.....
.....
.....
.....
.....
.....
.....
.....
..... [2]



- (f) Does the range of experimental values and your answer to (d) support the suggested formula, ZnI_2 ?
Explain your answer.

.....
.....
.....
.....
..... [1]

- (g) By referring to your calculated values in (a) identify any single weakness in the experimental method that could lead to errors in the results of the experiment.

.....
.....
.....
..... [1]

- (h) A student suggests an alternative method with iodine in excess rather than zinc. Suggest a reagent that could be used, in a titration, to determine the amount of iodine remaining in solution after the reaction.

..... [1]

[Total: 15]



- 3 A group of students perform an experiment to confirm that the formula of magnesium oxide is MgO. Each student is provided with a different length of magnesium ribbon which is coiled and heated in a crucible fitted with a lid. The magnesium reacts with oxygen to form magnesium oxide.

The instructions for the experiment are as follows.

- Weigh the empty crucible and lid.
- Coil the length of magnesium ribbon and place it in the bottom of the crucible.
- Reweigh the crucible and lid with the magnesium.
- Heat the crucible with a Bunsen burner.
- Periodically lift the crucible lid for a very short period of time. This allows air to enter the crucible.
- Each time the lid is lifted, take care to minimise the loss of any white smoke which is some of the powder formed.
- When the reaction appears to have stopped, remove the crucible lid and heat the crucible and its contents strongly for 2 minutes.
- Cool and reweigh the crucible, lid and the contents.

The results of the experiment are given below.

student	mass of crucible and lid / g	mass of crucible and lid + magnesium / g	mass of crucible and lid + magnesium oxide / g	mass of magnesium / g	mass of magnesium oxide / g
1	25.37	26.62	27.50		
2	25.18	27.01	28.19	1.83	3.01
3	25.44	27.73	29.19	2.29	3.75
4	25.26	27.71	24.96	2.45	
5	25.39	28.11	29.84	2.72	4.45
6	25.04	27.89	28.54	2.85	3.50
7	25.13	28.08	29.93		

- (a) Complete the table above for student 1, student 4 and student 7.

Plot the data for student 1 and for student 7 on the graph on the next page.

[1]

(b) If the formula of magnesium oxide is MgO, the straight line indicates the mass of magnesium oxide formed from a given mass of magnesium.

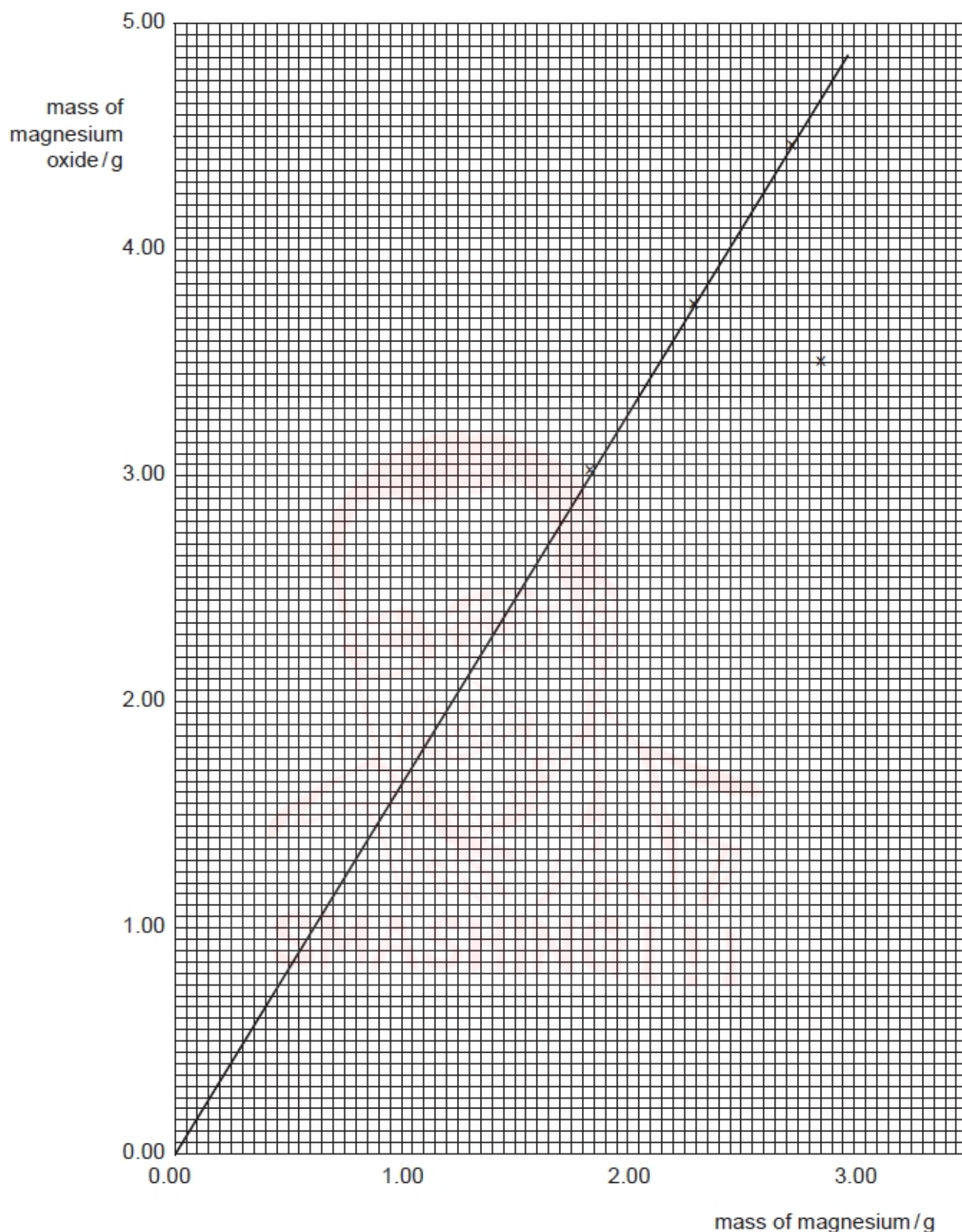

Choose a mass of Mg and use the straight line to determine the corresponding mass of MgO formed.

..... g of magnesium form g of magnesium oxide. [1]

- (c) Show by calculation that the masses of magnesium and magnesium oxide selected in (b) correspond to a formula of MgO.
[A_r : O, 16.0; Mg, 24.3]

[1]

- (d) The point plotted for student 6 shows a large deviation from the straight line. Refer to the instructions for the experiment and suggest a possible explanation for this anomalous result.

.....
.....
..... [1]

- (e) The result for student 4 could not be plotted on the graph. Suggest an error in carrying out the experiment that could have led to this result.

.....
.....
..... [1]

- (f) Student 1 added a few drops of water to the cooled residue in the crucible. The residue and water reacted to produce ammonia gas, NH_3 . Explain why this observation reduces confidence in this experiment as a method for determining the formula of magnesium oxide.

.....
.....
..... [1]

[Total: 6]



- 2 Hydrated iron(II) sulfate can be represented as $\text{FeSO}_4 \cdot x\text{H}_2\text{O}$ where x is the number of molecules of H_2O for each FeSO_4 . When the compound is heated, it loses the molecules of water leaving anhydrous iron(II) sulfate.

A suggested equation is:



An experiment is carried out to attempt to determine the value of x .

- An open crucible is weighed and the mass recorded.
- A sample of hydrated iron(II) sulfate is added to the crucible and the new mass recorded.
- The crucible with hydrated iron(II) sulfate is heated strongly for five minutes and allowed to cool back to room temperature.
- The crucible with the contents is reweighed and the mass recorded.

- (a) Calculate the relative formula masses, M_r , of FeSO_4 and H_2O .

[A_r : H, 1.0; O, 16.0; S, 32.1; Fe, 55.8]

[1]

- (b) The results of several of these experiments are recorded below.

Process the results in the table to calculate both the number of moles of anhydrous iron(II) sulfate and the number of moles of water.

Record these values in the additional columns of the table.

You may use some or all of the columns.

Masses should be recorded to **two decimal places**, while the numbers of moles should be recorded to **three significant figures**.

Label the columns you use. For each column you use include units where appropriate and an expression to show how your values are calculated.

You may use the column headings A to G for these expressions (e.g. A–B).

A	B	C	D	E	F	G
mass of crucible /g	mass of crucible + $\text{FeSO}_4 \cdot x\text{H}_2\text{O}$ /g	mass of crucible + FeSO_4 /g				
15.20	17.03	16.20				
15.10	17.41	16.41				
14.95	17.33	16.25				
15.15	17.70	16.54				
15.05	17.79	16.55				
14.90	17.88	16.53				
14.92	18.18	16.70				
15.30	18.67	17.14				
15.07	18.64	17.02				
15.01	18.80	17.04				

[2]

- (c) Plot a graph to show the relationship between the number of moles of anhydrous iron(II) sulfate, FeSO_4 (x -axis), and the number of moles of water (y -axis). Draw the line of best fit. It is recommended that you do not include the origin in your choice of scaling.

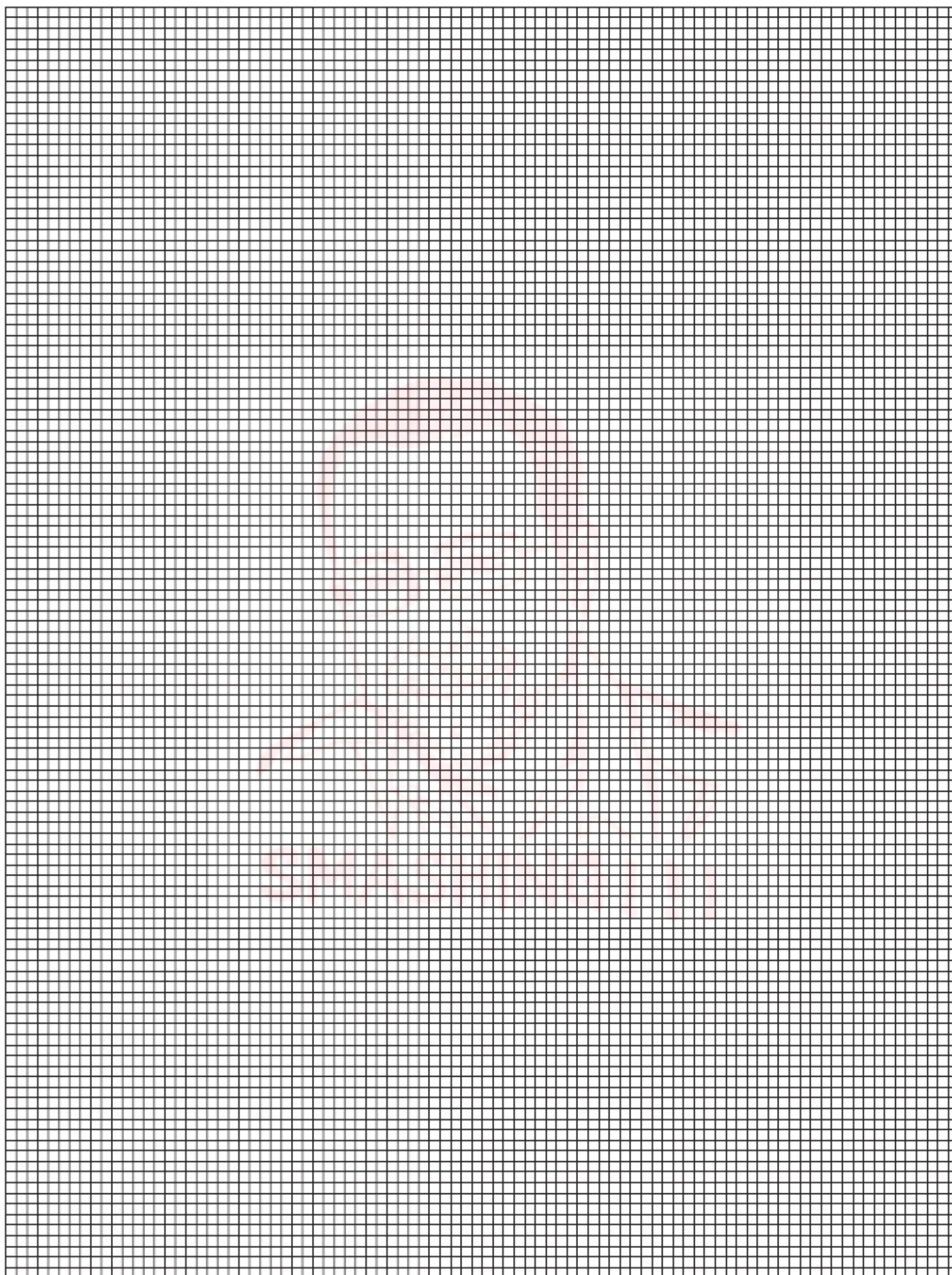

[3]

- 1 The enthalpy change of reaction, ΔH_r , for the decomposition of sodium hydrogencarbonate, $\text{NaHCO}_3(\text{s})$, cannot be measured directly.

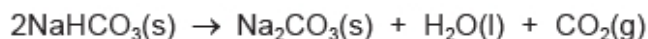

A student must carry out **two** separate experiments and use the results of these experiments to determine the enthalpy change of reaction for the decomposition of sodium hydrogencarbonate.

- (a) Suggest why the enthalpy change of reaction, ΔH_r , for the decomposition of sodium hydrogencarbonate cannot be measured directly.

.....
 [1]

In both experiments the student used a weighing boat. A weighing boat is a small vessel used to contain solid samples when they are weighed.

Experiment 1 Reaction between sodium carbonate, $\text{Na}_2\text{CO}_3(\text{s})$, and dilute hydrochloric acid, $\text{HCl}(\text{aq})$

step 1 The student added approximately 3g of $\text{Na}_2\text{CO}_3(\text{s})$ to a weighing boat and accurately measured the combined mass of the weighing boat and $\text{Na}_2\text{CO}_3(\text{s})$. This mass was recorded in Table 1.1.

step 2 The student used a measuring cylinder to measure 50 cm^3 of $2 \text{ mol dm}^{-3} \text{ HCl}(\text{aq})$.

step 3 The experiment was carried out and the results were recorded in Table 1.2.

step 4 The student reweighed the empty weighing boat and recorded the mass in Table 1.1.

Table 1.1 mass results from Experiment 1

mass of weighing boat and $\text{Na}_2\text{CO}_3(\text{s})/\text{g}$	4.15
mass of empty weighing boat after addition of $\text{Na}_2\text{CO}_3(\text{s})$ to $\text{HCl}(\text{aq})/\text{g}$	0.97
mass of $\text{Na}_2\text{CO}_3(\text{s})$ added/g	

Table 1.2 temperature results from Experiment 1

time/minutes	0	1	2	3		5	6	7	8	9	10
temperature of mixture/ $^{\circ}\text{C}$	20.0	19.8	19.8	19.8		24.6	24.7	24.5	24.3	24.1	23.9



(b) Outline how the student carried out **step 3** of the experiment.
You may find it helpful to write your answer as a series of smaller steps.

.....

.....

.....

.....

.....

.....

Draw a labelled diagram of the apparatus.



[3]



The student plotted a graph of the results and drew **two** lines of best fit which were both extrapolated as shown.

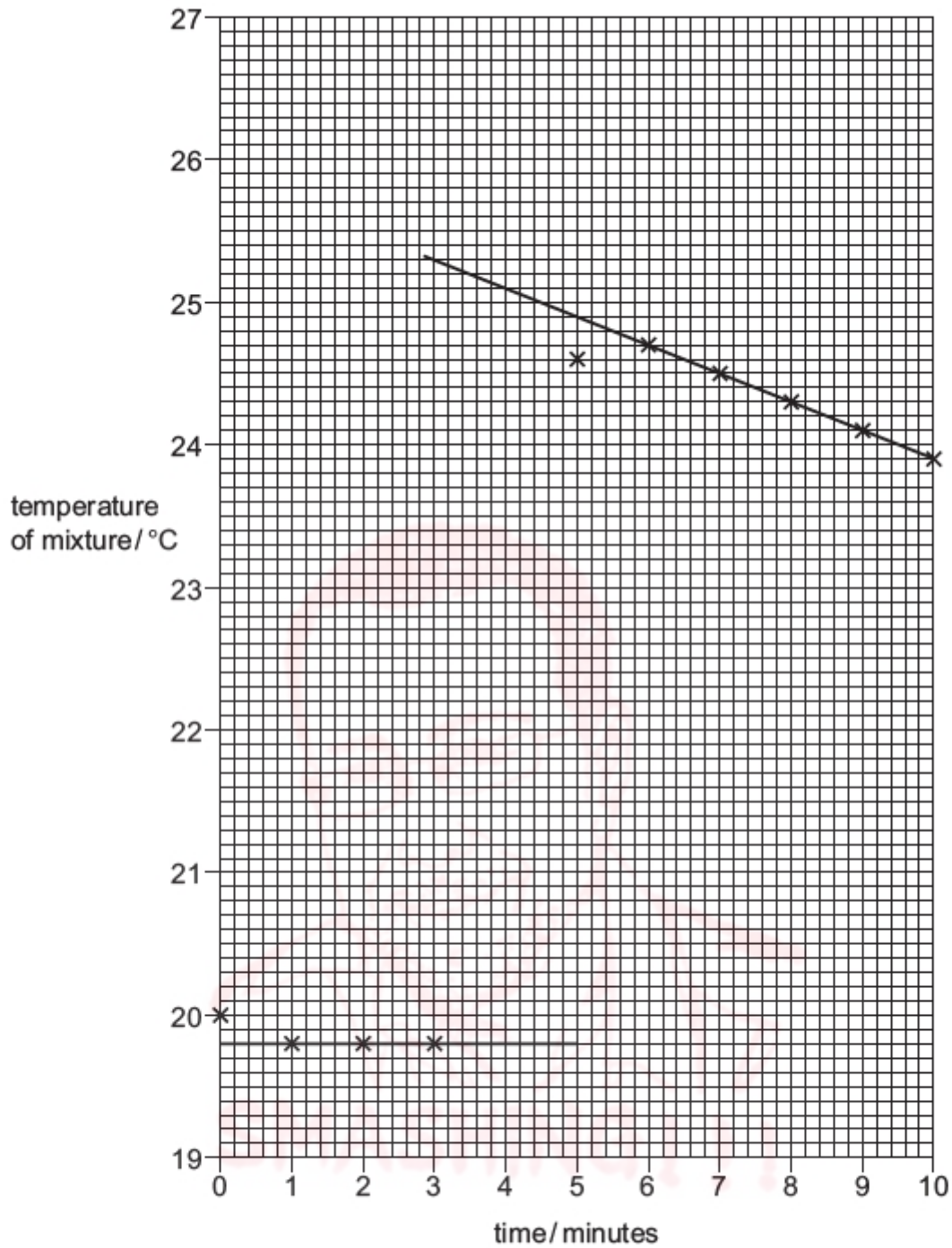

(c) Use the graph to determine the theoretical temperature increase at 4 minutes.

theoretical temperature increase = °C [1]



- (d) Use Table 1.1 on page 2 to determine the mass of $\text{Na}_2\text{CO}_3(\text{s})$ which was added to the $\text{HCl}(\text{aq})$. Use this value and your answer to (c) to determine the enthalpy change, ΔH_1 , for the reaction shown.



Give your answer to **three** significant figures.

[Assume that the specific heat capacity of the solution is $4.18 \text{ J g}^{-1} \text{ K}^{-1}$.]

[A_r: Na, 23.0; C, 12.0; O, 16.0]

$\Delta H_1 = \dots\dots\dots \text{ kJ mol}^{-1}$ [3]

- (e) (i) Explain why the student did **not** add the $\text{Na}_2\text{CO}_3(\text{s})$ to the $\text{HCl}(\text{aq})$ at 0 minutes.

.....
..... [1]

- (ii) Suggest why the temperature measured at 5 minutes was lower than the temperature measured at 6 minutes.

.....
..... [1]



Experiment 2 Reaction between sodium hydrogencarbonate, $\text{NaHCO}_3(\text{s})$, and dilute hydrochloric acid, $\text{HCl}(\text{aq})$

- step 1** The student weighed an empty weighing boat and recorded the mass in Table 1.3.
- step 2** The student added exactly 4.20 g of $\text{NaHCO}_3(\text{s})$ to the weighing boat and recorded the mass in Table 1.3.
- step 3** The student carried out the same experimental procedure as in **steps 2** and **3** of Experiment 1.

Table 1.3 mass results from Experiment 2

mass of empty weighing boat/g	0.95
mass of weighing boat and $\text{NaHCO}_3(\text{s})/\text{g}$	5.15
mass of $\text{NaHCO}_3(\text{s})$ added/g	

- (f) Explain why the method of determining the mass of solid added in Experiment 2 is less accurate than the method of determining the mass of solid added in Experiment 1.

.....
..... [1]

- (g) (i) In Experiment 2 a 50 cm^3 measuring cylinder was used to measure the 50 cm^3 of $\text{HCl}(\text{aq})$. The 50 cm^3 measuring cylinder had 1 cm^3 graduations.

Calculate the maximum percentage error in measuring 50 cm^3 of $\text{HCl}(\text{aq})$ with this 50 cm^3 measuring cylinder.

maximum percentage error = % [1]

- (ii) Explain why measuring the concentration of the 2 mol dm^{-3} HCl more precisely would **not** affect the result of the experiment.

.....
..... [1]

- (iii) Suggest what the student should change to reduce the percentage error associated with the temperature readings **without** changing the apparatus.

.....
..... [1]

- (h) The student used the results from Experiment 2 and correctly determined the enthalpy change for the reaction between $\text{NaHCO}_3(\text{s})$ and $\text{HCl}(\text{aq})$, ΔH_2 , to be $+24.2 \text{ kJ mol}^{-1}$.

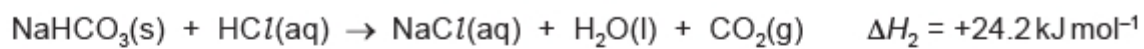

Use the axes to draw a sketch graph of the expected results of Experiment 2.

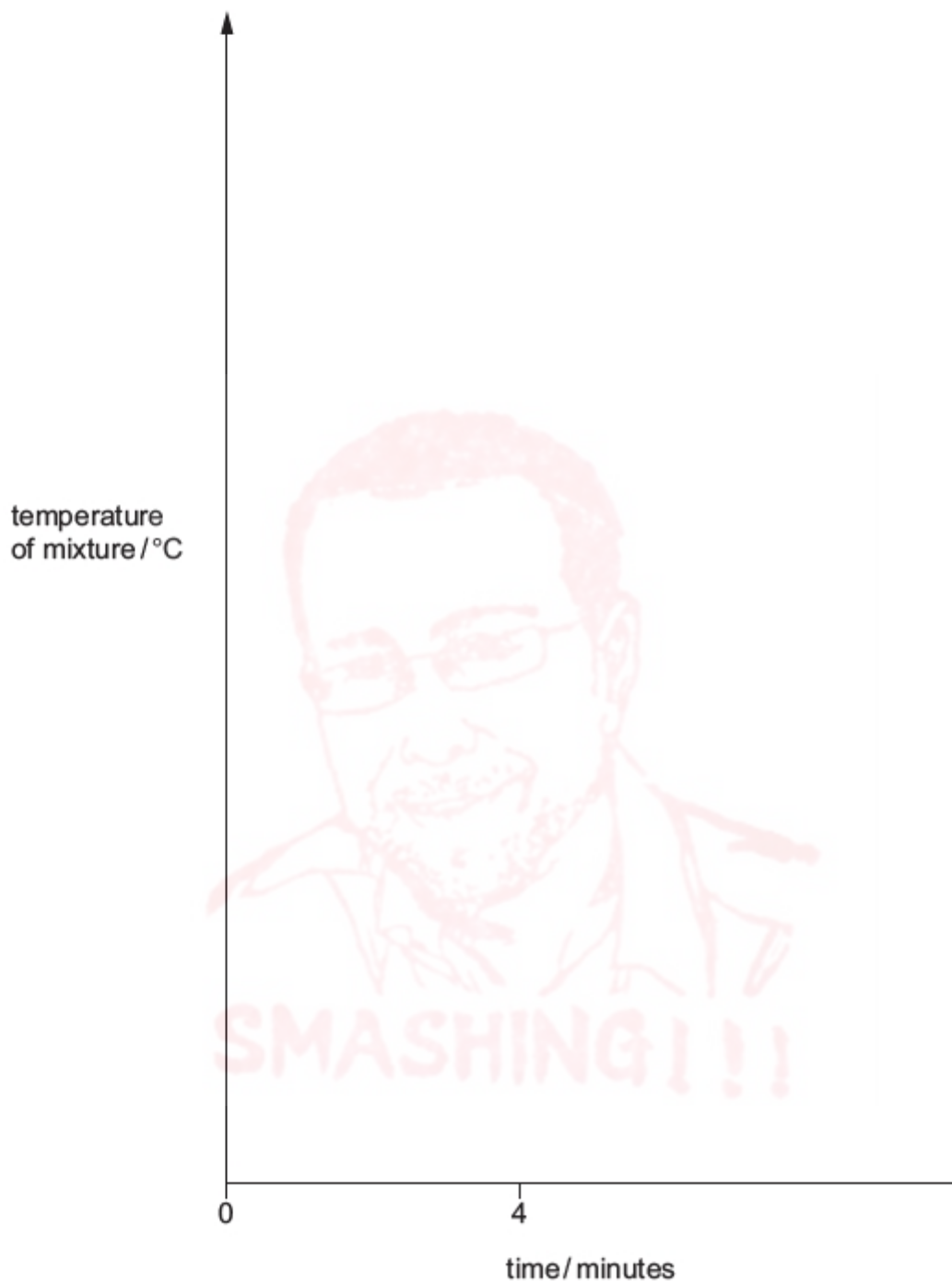

[2]

- (i) Use ΔH_1 from (d) and ΔH_2 from (h) to determine the enthalpy change of reaction, ΔH_r , for the decomposition of $\text{NaHCO}_3(\text{s})$.

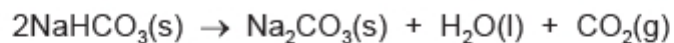

An energy cycle has been drawn for you.

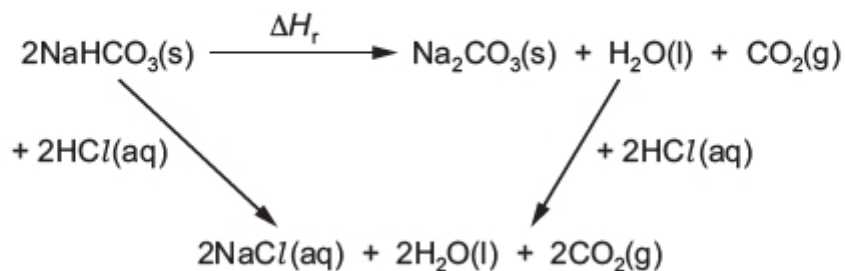

If you were unable to calculate ΔH_1 in (d), assume $\Delta H_1 = -26.7 \text{ kJ mol}^{-1}$. This is **not** the correct value of ΔH_1 .



$\Delta H_r = \dots\dots\dots \text{ kJ mol}^{-1}$ [2]

[Total: 18]

2 ASSESSMENT OF PLANNING SKILLS

Copper has two oxides, CuO and Cu₂O.

Each oxide can be reduced to copper metal by heating it in a stream of hydrogen gas.

The oxide turns to copper metal powder in an exothermic reaction in which the powder may be seen to glow red hot.

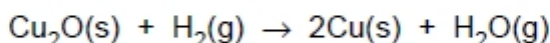
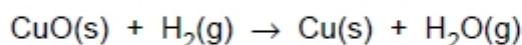

(a) Draw a diagram to show the assembled apparatus you could use in a school laboratory to carry out the reduction of one of the oxides. The apparatus should enable you to:

- (i) weigh the oxide before heating and the metallic copper after heating,
- (ii) condense, collect and weigh the steam/water produced,
- (iii) burn any excess hydrogen after it has passed through the apparatus.

You may assume that a supply of hydrogen gas is available – you do not have to prepare the gas. You need not draw a balance.

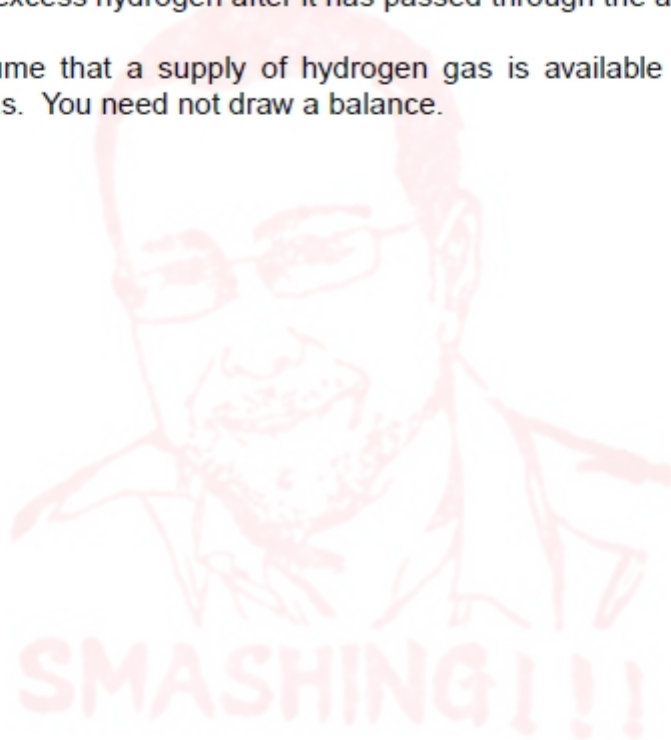

[3]

(b) At the start of the experiment the apparatus is full of air. Hydrogen and air mixtures are explosive.

What precaution could you take to prevent explosion when igniting the excess hydrogen leaving the apparatus?

.....

.....

..... [1]

(c) Why is it necessary to continue passing hydrogen gas through the apparatus until the copper metal formed has cooled?

.....
.....
..... [1]

(d) How could you be certain that all of the copper oxide had been reduced to copper?

.....
.....
..... [1]

(e) Show how you would use the data you could obtain from the experiment in (a) to deduce the formula of the oxide used.

[A_r : Cu, 63.5; O, 16.0]



[2]

[Total: 8]



2 A chloride of mercury has the formula HgCl_x .

The formula of the chloride can be determined experimentally. A solution of the chloride in water is reduced to mercury metal by the addition of hypophosphorous acid, H_3PO_2 .

Method

- A 100 cm^3 beaker is weighed empty and then with HgCl_x .
- The solid is dissolved in distilled water.
- The resulting solution is heated in a water bath.
- 10 cm^3 of hypophosphorous acid is added from a measuring cylinder.
- The mixture is stirred and heated for a further 5 minutes.
- The aqueous solution remaining after the reaction is poured off to leave droplets of mercury in the bottom of the beaker.
- The mercury is washed several times with distilled water, discarding the wash water each time.
- The beaker and mercury are dried by rinsing several times with propanone which dissolves any remaining water drops.
- The remaining propanone is evaporated by warming the beaker.
- The beaker and mercury are weighed.
- The experiment is repeated using different masses of HgCl_x .

Observations

- HgCl_x dissolves in water to form a colourless solution.
- On adding H_3PO_2 a white suspension forms which rapidly turns to a grey suspension of droplets of metallic mercury.
- On further heating, the suspended droplets merge to form large drops of mercury at the bottom of the beaker.

Results

	A	B	C	D	E	F
experiment	mass of beaker /g	mass of beaker + mercury chloride /g	mass of beaker + mercury /g			
1	54.87	55.52	55.30			
2	54.64	55.88	55.59			
3	56.70	58.38	57.94			
4	51.03	53.34	52.53			
5	55.33	58.74	57.84			
6	53.05	57.20	56.10			
7	53.92	58.57	57.17			
8	55.26	61.09	59.57			

- (a) Process the results in the table to produce data that will enable you to plot a graph from which the formula of HgCl_x can be determined.
Record this data in the additional columns of the table. You may use some or all of the columns.
Label the columns you use. For each column, include the units and an equation to show how your values are calculated. You may use the column headings **A** to **F** in the equations e.g. **C** – **B**. [2]

- (b) Present the data calculated in (a) in graphical form. Draw the line of best-fit.

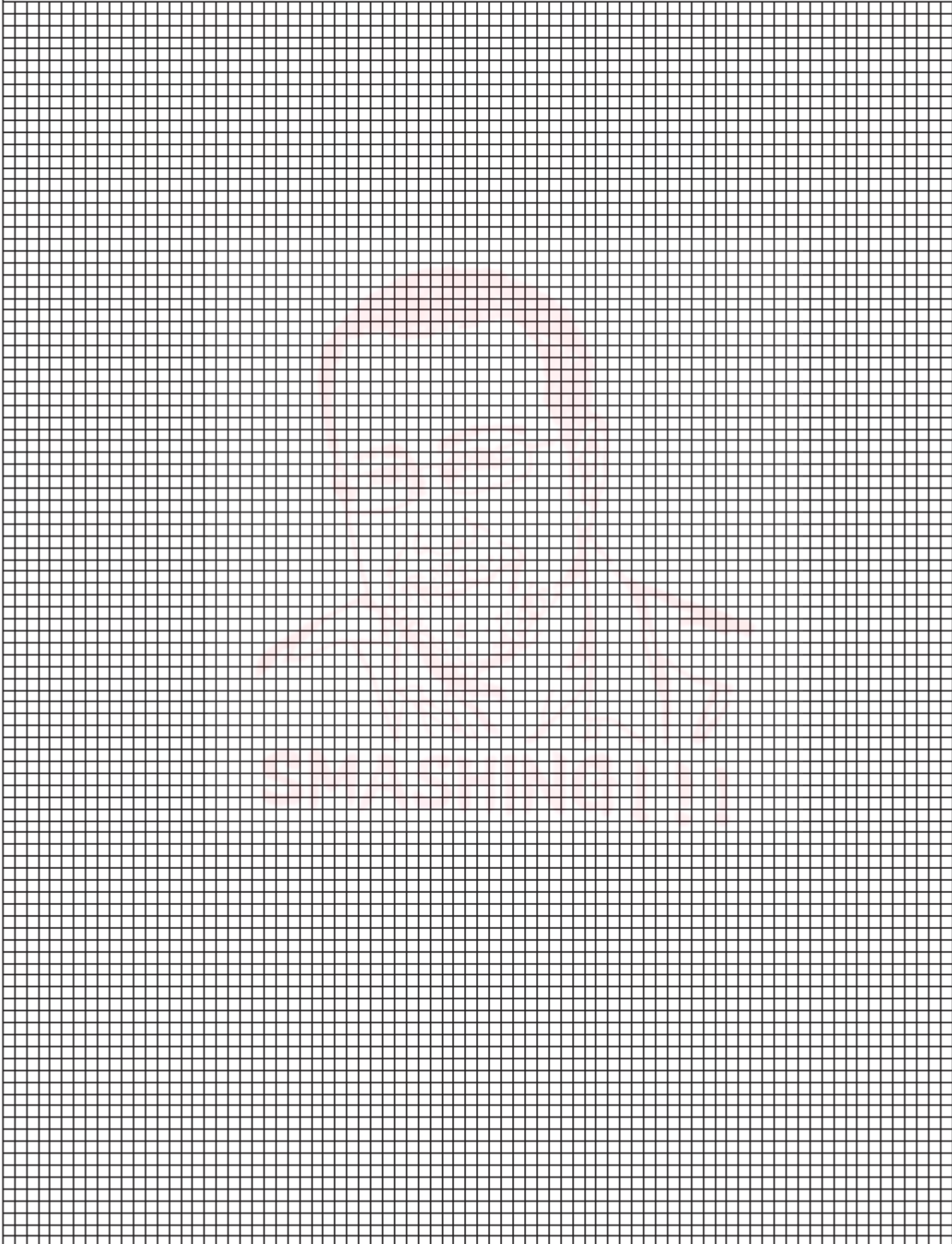

[4]



- (g) The mass of chlorine in HgCl_x can also be determined by precipitation of an insoluble chloride. Use your knowledge of halogen chemistry to suggest a suitable reagent for this reaction.

.....
.....[1]

[Total: 15]



- 1 There are three oxides of lead, PbO , PbO_2 and Pb_3O_4 , all of which can be reduced to metallic lead by hydrogen.

The following information gives some of the hazards associated with these compounds.

Lead oxides

Lead(II) oxide (PbO) **Lead(IV) oxide** (PbO_2) **Dilead(II) lead(IV) oxide** (Pb_3O_4)

Toxic Dangerous for the environment

Harmful by inhalation and if swallowed. Danger of cumulative effects.

Hydrogen Extremely flammable. Readily forms an explosive mixture with air. Mixtures between 4 and 74 % by volume are explosive.

An unknown sample of an oxide of lead can be identified by investigating the molar ratio of oxygen atoms to lead atoms.

You are to plan an experiment to investigate the molar ratio of oxygen atoms to lead atoms in the oxide sample. Your plan should result in a correct identification of the oxide.

- (a) Calculate the number of moles of oxygen atoms that combine with one mole of lead atoms in each of the three oxides.

[2]

- (b) Draw a sketch graph to show how the number of moles of oxygen atoms varies with the number of moles of lead for lead(II) oxide, PbO . Draw two more sketch graphs to show this relationship for the other two oxides. Label clearly each axis and each graph.

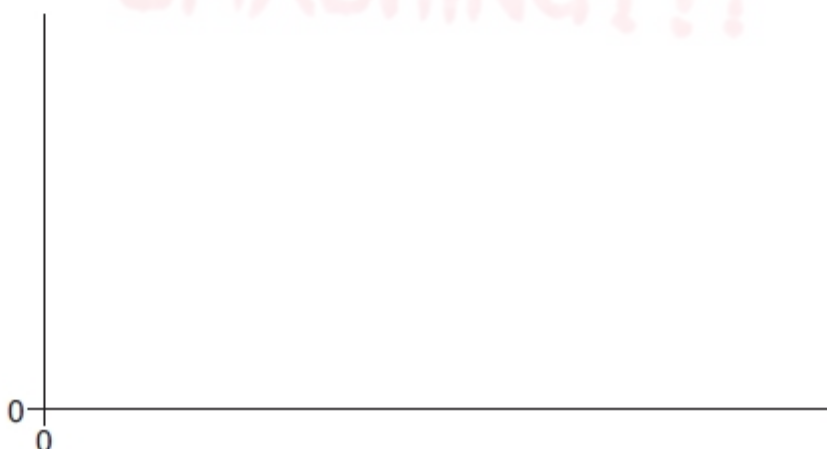

[2]

(c) In the experiment you are about to plan, identify the following.

(i) the independent variable

(ii) the dependent variable

[1]

(d) Draw a diagram of the apparatus and experimental set up you would use to determine the chemical formula of the oxide. Your apparatus should use only standard items found in a school or college laboratory and should show clearly

(i) how the hydrogen gas needed for the reduction is prepared, naming the chemicals (reagents) to be used,

(ii) how the oxide of lead will be heated,

(iii) how any excess hydrogen is dealt with safely.

Label each piece of apparatus used.



[3]



- (e) Using the apparatus shown in (d), design a laboratory experiment which will enable you to determine the chemical formula of the oxide.

Give a step-by-step description of how you would carry out the experiment by

- (i) stating a suitable mass of the oxide of lead,
- (ii) stating how you would ensure that the decomposition is complete,
- (iii) showing by calculation the minimum volume of hydrogen, measured at 25 °C, that would be needed to reduce the mass of oxide of lead stated in (i) above. For calculation purposes, you may assume that the oxide of lead is PbO,
- (iv) stating how you would use your results to reach a conclusion.

[A_r : H, 1.0; O, 16.0; Pb, 207.0; the molar volume of a gas at 25 °C is 24.0 dm³]



[4]



- (f) State one hazard that must be considered when planning the experiment and describe a precaution that should be taken to minimise the risk from this hazard.

.....

.....

.....

..... [1]

- (g) Draw up a table with appropriate headings to show the data you would record when carrying out your experiments and the values you would calculate in order to determine graphically the formula of the oxide. The headings should include appropriate units.



[2]

[Total: 15]

2 When sodium nitrate, NaNO_3 , is heated, it decomposes into sodium nitrite, NaNO_2 , and oxygen.

A suggested equation is:-

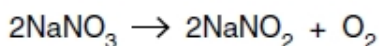

An experiment was carried out to attempt to confirm this.

- An empty boiling tube was weighed and the mass recorded.
- A sample of sodium nitrate was added to the boiling tube and the new mass recorded.
- The boiling tube and sodium nitrate was heated strongly for five minutes and then allowed to cool back to room temperature.
- The boiling tube and contents was then reweighed and the mass recorded.

(a) Calculate the relative molecular masses (M_r) of NaNO_3 and NaNO_2 .
[A_r : N, 14.0; O, 16.0; Na, 23.0]

[1]

(b) The results of several such experiments are recorded below.

A	B	C	D	E	F	G
mass of boiling tube / g	mass of boiling tube + NaNO_3 / g	mass of boiling tube + NaNO_2 / g				
9.90	13.10	12.50				
10.05	14.73	13.91				
10.25	14.20	13.46				
9.80	12.67	12.65				
9.60	14.56	13.63				
10.30	15.80	14.76				
11.05	17.18	15.50				
10.00	17.00	15.68				
9.75	17.65	16.16				
10.15	18.48	16.84				

Process the results in the table to calculate the number of moles of sodium nitrate and the number of moles of sodium nitrite.

Record these values in the additional columns of the table. You may use some or all of the columns.

Masses should be recorded to **two decimal places**. Numbers of moles should be recorded to **two significant figures**.

Label the columns you use. For each column you use include units where appropriate and an expression to show how your values are calculated. You may use the column headings A to G for these expressions (e.g. A–B). [2]

- (c) Plot a graph to show the relationship between the number of moles of sodium nitrate and the number of moles of sodium nitrite.
Draw the line of best fit.

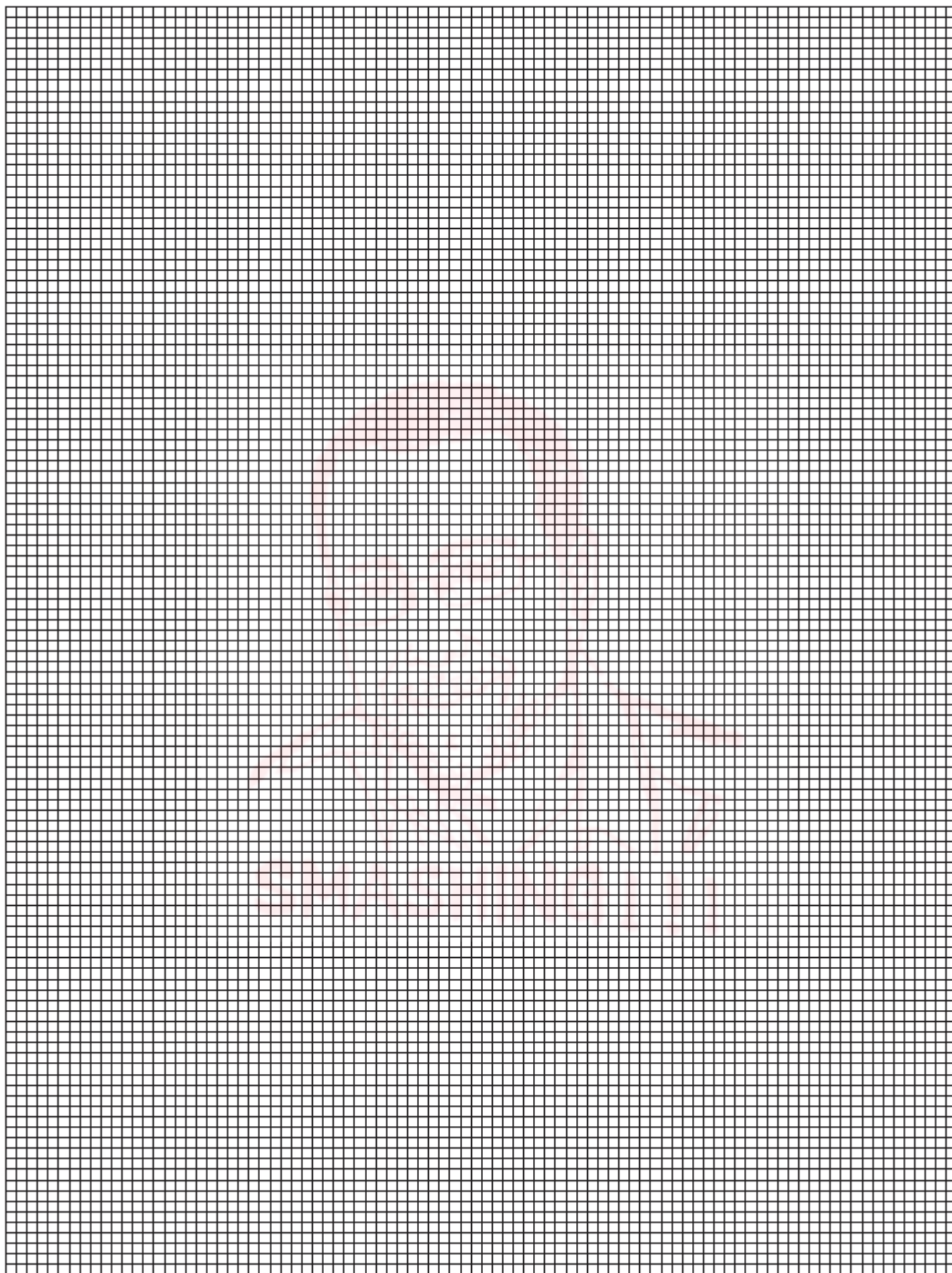

[3]

Thermometric titration

- 2 **FB 3** is 1.50 mol dm^{-3} sodium hydroxide, NaOH.
FB 4 is an aqueous solution containing hydrochloric acid.

FB 4 has been prepared by dissolving 42.40 g of the carbonate **FB 2** in an excess of 3.00 mol dm^{-3} hydrochloric acid and making the solution up to 1 dm^3 in a graduated flask by adding more 3.00 mol dm^{-3} hydrochloric acid.

You are to perform a thermometric titration to determine the end-point for the reaction of **FB 3** and **FB 4**. In a thermometric titration the end-point is when the maximum temperature change occurs.

- (a) Fill the burette with **FB 4**.

Support the plastic cup in a 250 cm^3 beaker and pipette into the cup 50.0 cm^3 of **FB 3**.

Record the steady temperature of **FB 3** in Table 2.1.

Read through the following instructions before starting the experiment.

Run 3.00 cm^3 of **FB 4** from the burette into the cup, stir the solution with the thermometer and record the new steady temperature. **Without delay** run a further 3.00 cm^3 of **FB 4** from the burette, stir and record the steady temperature as before. Continue the addition of **FB 4** in 3.00 cm^3 portions, taking and recording the steady temperature each time, until 48.00 cm^3 of solution **FB 4** have been run from the burette. Record all temperatures in Table 2.1.

The thermometer provided has a range from $^{\circ}\text{C}$ to $^{\circ}\text{C}$

and has graduations at each $^{\circ}\text{C}$.

volume of FB 4 added / cm^3	temperature / $^{\circ}\text{C}$	Δt (temperature – initial temperature) / $^{\circ}\text{C}$	volume of FB 4 added / cm^3	temperature / $^{\circ}\text{C}$	Δt (temperature – initial temperature) / $^{\circ}\text{C}$
0		0	27.00		
3.00			30.00		
6.00			33.00		
9.00			36.00		
12.00			39.00		
15.00			42.00		
18.00			45.00		
21.00			48.00		
24.00					

Table 2.1

[5]



(b) Plot a graph of Δt against the volume of **FB 4** added.

Draw two smooth curves through the plotted points to find the end-point for the titration.

[3]

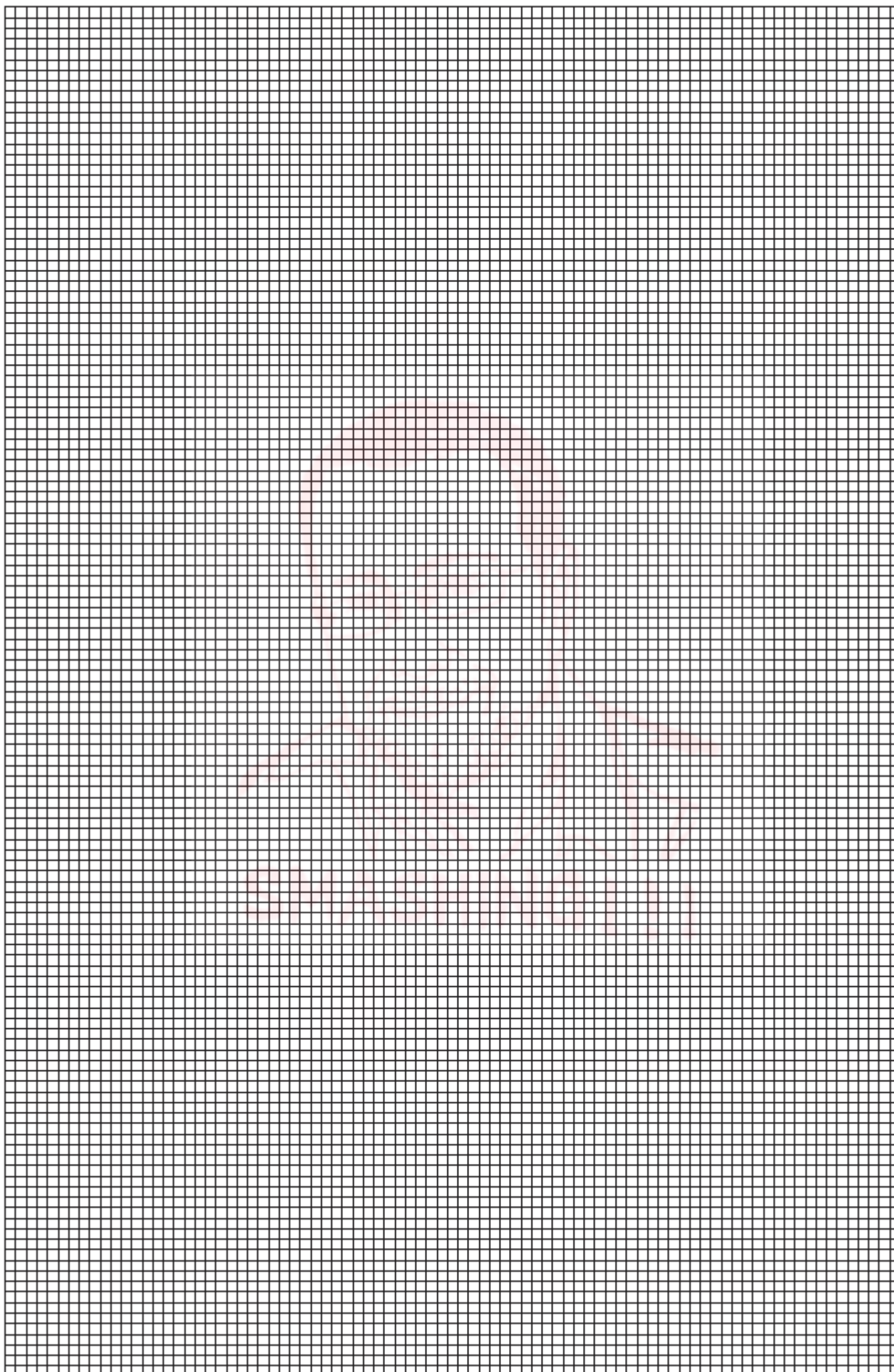

(c) Read from the graph the volume of hydrochloric acid, **FB4**, at the end-point of the titration.

..... cm³ [1]

(d) Use your answer to (c) and the equation for the reaction to calculate the concentration of the hydrochloric acid in **FB 4**.

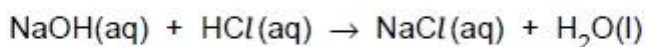

..... [1]

(e) The solution **FB 4** was prepared by dissolving 42.40 g of X_2CO_3 in 1 dm³ of 3.0 mol dm⁻³ HCl.

Use this information and your answer to (d) to calculate the number of moles of HCl that reacted with the dissolved X_2CO_3 .

..... [1]

(f) Calculate the relative molecular mass, M_r , of X_2CO_3 .

Calculate the relative atomic mass, A_r , of **X**.
[A_r : C, 12.0; O, 16.0.]

$A_r =$ [1]

[Total : 12]

1 The neutralisation of an acid by a base is exothermic.

In this experiment the following solutions are available.

- 2 mol dm⁻³ sulfuric acid, H₂SO₄
- 3 mol dm⁻³ sodium hydroxide, NaOH

The equation for the reaction is:

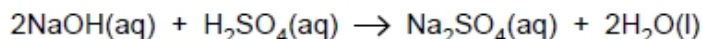

- (a) 2 mol dm⁻³ H₂SO₄ is gradually added to a fixed volume of 3 mol dm⁻³ NaOH in a 150 cm³ plastic cup, while stirring continuously. The temperature of the solution, measured with a thermometer, increases until the alkali is just neutralised. On further addition of the cold acid the temperature of the solution slowly falls.

Select an appropriate volume, x cm³, of 3 mol dm⁻³ NaOH to use in the experiment.

..... cm³

Calculate the volume of 2 mol dm⁻³ H₂SO₄ that will just neutralise x cm³ of 3 mol dm⁻³ NaOH.

Sketch the graph you would expect to obtain as the acid is added.
Label the neutralisation point.



[3]



- (b) This experiment can be used to determine the enthalpy change of neutralisation for the reaction. To ensure reliable results the experiment should be repeated a number of times.

When sulfuric acid is added to the fixed volume of aqueous sodium hydroxide in this experiment

- (i) the independent variable is,
- (ii) the dependent variable is,
- (iii) the other variables that need to be controlled are
- [3]

- (c) In carrying out the experiment, what apparatus would you use to accurately measure the independent variable?
- [1]

- (d) Explain how you would use this apparatus to control the independent variable.
- [1]

- (e) Identify and assess

- (i) a risk associated with the plastic cup used in this experiment,

.....

.....

- (ii) a risk associated with the 3 mol dm^{-3} NaOH.

.....

.....

[1]

(f) Describe how the risks in (e) can be kept to a minimum for

(i) the plastic cup,

.....
.....

(ii) the $3 \text{ mol dm}^{-3} \text{ NaOH}$.

.....
.....

[1]

(g) In the space below draw a table to show column headings for all of the measurements you would make during the experiment. Include in the table one or more columns for any calculated values needed to determine the enthalpy change of neutralisation.



[2]



- (h) Show how you would calculate the total heat energy produced in the plastic cup up to the point when the sulfuric acid has just neutralised the sodium hydroxide. You may use ΔT to represent the temperature change.

[4.3J of heat energy raise the temperature of 1 cm³ of any solution by 1 °C.]

[1]

- (i) The enthalpy change of neutralisation is the energy change associated with the reaction shown by the following equation.

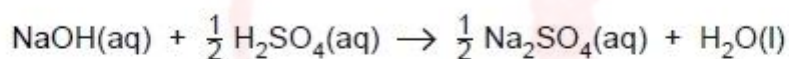

Show how you would convert the energy change expressed in (h) into a value, in kJ mol^{-1} , for the enthalpy change of neutralisation, $\Delta H_{\text{neutralisation}}$. Show clearly the sign and the expression for the enthalpy change.

$\Delta H_{\text{neutralisation}} = \dots\dots\dots \text{kJ mol}^{-1}$ [2]
sign *expression*

[Total: 15]

EXPERIMENT Required, no longer needed from 2007 onwards.

- 1 **FB 1** is a solution of sulphuric acid.
FB 2 is 2.00 mol dm^{-3} sodium hydroxide, NaOH.

Determining the concentration of sulphuric acid by thermometric titration.

Record the temperature of each solution, taking care to wash and dry the thermometer before measuring the temperature of the second solution. Read the temperature to the nearest 0.5°C , and record the temperature of each solution in Table 1.1. Calculate the average temperature of the two solutions.

Table 1.1

	$/^\circ\text{C}$
temperature of solution FB 1	
temperature of solution FB 2	
average temperature	

[2]

Support the plastic cup in a 250 cm^3 beaker. Use one of the measuring cylinders to transfer 40 cm^3 of **FB 2**, sodium hydroxide solution, into the plastic cup. Replace the stopper or cover over **FB 2** to prevent any reaction of carbon dioxide in the air with the sodium hydroxide.

Using the second measuring cylinder transfer 10 cm^3 of **FB 1**, sulphuric acid, into the sodium hydroxide in the plastic cup. Stir the mixture with the thermometer and note the highest temperature obtained.

This temperature should be recorded in Table 1.2 for experiment 1.

Empty, rinse and dry the plastic cup. Repeat the experiment with the other mixtures shown in Table 1.2 and record the highest temperature reached in each mixture.

Table 1.2

experiment	1	2	3	4	5	6	
volume of FB 2 / cm^3	40	35	30	25	20	15	
* volume of FB 1 / cm^3	10	15	20	25	30	35	*
maximum temperature / $^\circ\text{C}$							

For each experiment use the average initial temperature from Table 1.1 to calculate and record the temperature rise after mixing the solutions.

experiment	1	2	3	4	5	6	
* moles of sodium hydroxide	0.08	0.07	0.06	0.05	0.04	0.03	*
temperature rise / $^\circ\text{C}$							

[4]

(a) Plot the temperature rise against moles of sodium hydroxide on the grid below. [2]

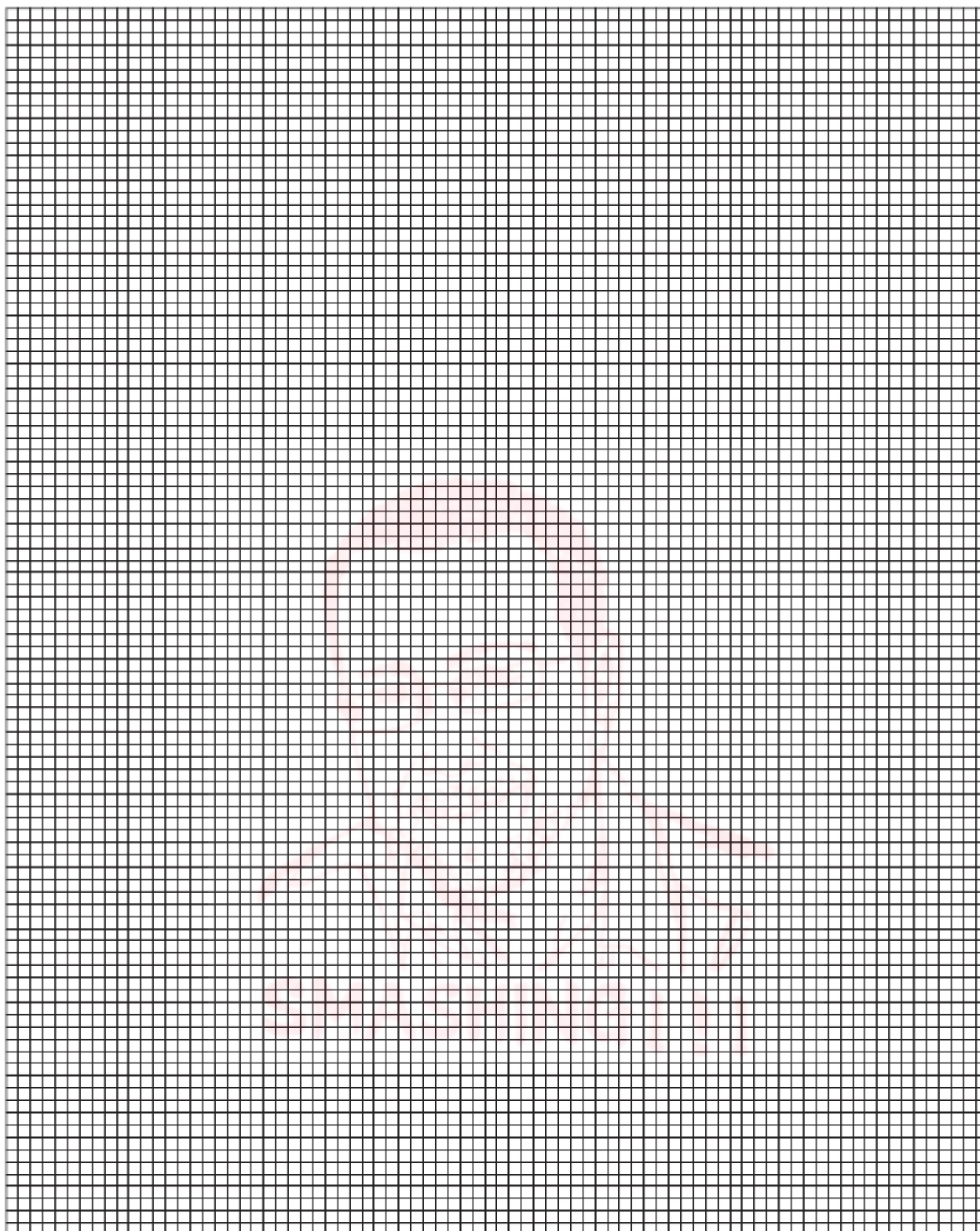

(b) Draw **two appropriate straight lines** through your plotted points to show an end-point for the neutralisation. [1]

(c) Deduce from your graph, the number of moles of sodium hydroxide that reacted at the end-point.

..... mol
[1]

- (d) Use your answer to (c) and data from the lines in Table 1.2 marked with asterisks (*) to calculate the volume of sulphuric acid, **FB 1**, reacting at the end-point.

[1]

- (e) Calculate how many moles of sulphuric acid reacted with the sodium hydroxide at the end-point.

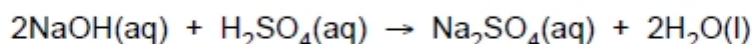

[1]

- (f) Calculate, in mol dm^{-3} , the concentration of the sulphuric acid in **FB 1**.

[1]

Determining the enthalpy change for the reaction $\text{H}^+(\text{aq}) + \text{NaOH}(\text{s}) \rightarrow \text{H}_2\text{O}(\text{l}) + \text{Na}^+(\text{aq})$

Empty, rinse and dry the plastic cup used in the first part of the question. Using a measuring cylinder transfer 50 cm^3 of **FB 1** into the cup. When the temperature is steady, record its value in Table 1.3.

Weigh the tube labelled **FB 3** which contains solid sodium hydroxide. Record the mass in Table 1.3. Tip the contents of the tube into the plastic cup, stir, and record the highest temperature achieved in Table 1.3.

Weigh the empty tube and record its mass in Table 1.3.

Table 1.3

initial temperature of FB 1 / °C	
maximum temperature after mixing FB 1 and FB 3 / °C	
mass of tube + FB 3 / g	
mass of empty tube / g	

Complete the table by calculating the temperature rise and mass of **FB 3** added.

temperature rise / °C	
mass of FB 3 added / g	

[4]



- (g) Calculate the heat energy released during the reaction of **FB 1** and **FB 3** in the cup.
[Assume that 4.3 J are required to raise the temperature of 1 cm³ of solution by 1 °C.]

energy released [1]

- (h) Use data from Table 1.3 and your answer to (f) to calculate which of sodium hydroxide or sulphuric acid is in excess.
If you are unable to obtain a value in (f) use 1.50 mol dm⁻³ as the concentration of the sulphuric acid.

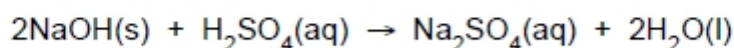

[A_r: Na, 23.0; O, 16.0; H, 1.0]

..... is in excess. [1]

- (i) Calculate the enthalpy change, ΔH , for the following reaction.

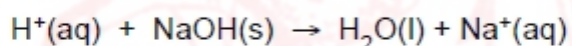

$\Delta H =$ kJ mol⁻¹ [1]

[Total: 20]

- 2 In an experiment, various masses of solid barium hydroxide are added to 60.0 cm³ of a solution of hydrochloric acid contained in a polystyrene cup.

In each experiment a fresh sample of the acid is taken and its initial temperature is measured. After the barium hydroxide has been added, the acid is stirred and the maximum temperature reached is noted.

The results of each experiment are recorded in the table below.

- (a) Complete the table below to give the temperature rise obtained from each experiment to **one decimal place** and the amount of barium hydroxide used in mol to **three significant figures** in each case.

The mass of 1 mol of barium hydroxide is 171 g.

initial temperature of HCl/°C	mass of barium hydroxide added /g	maximum temperature reached /°C	temperature rise /°C	barium hydroxide added / mol
21.0	0.500	22.2		
20.6	1.00	23.0		
21.2	1.50	24.9		
21.8	2.00	26.5		
20.5	3.00	27.8		
21.4	4.00	31.1		
21.2	5.00	31.6		
21.0	6.00	31.4		
20.8	8.00	31.2		

[2]

- (b) (i) Using the grid on page 7, plot a graph to show how the temperature rise varies with the moles of barium hydroxide added. [1]

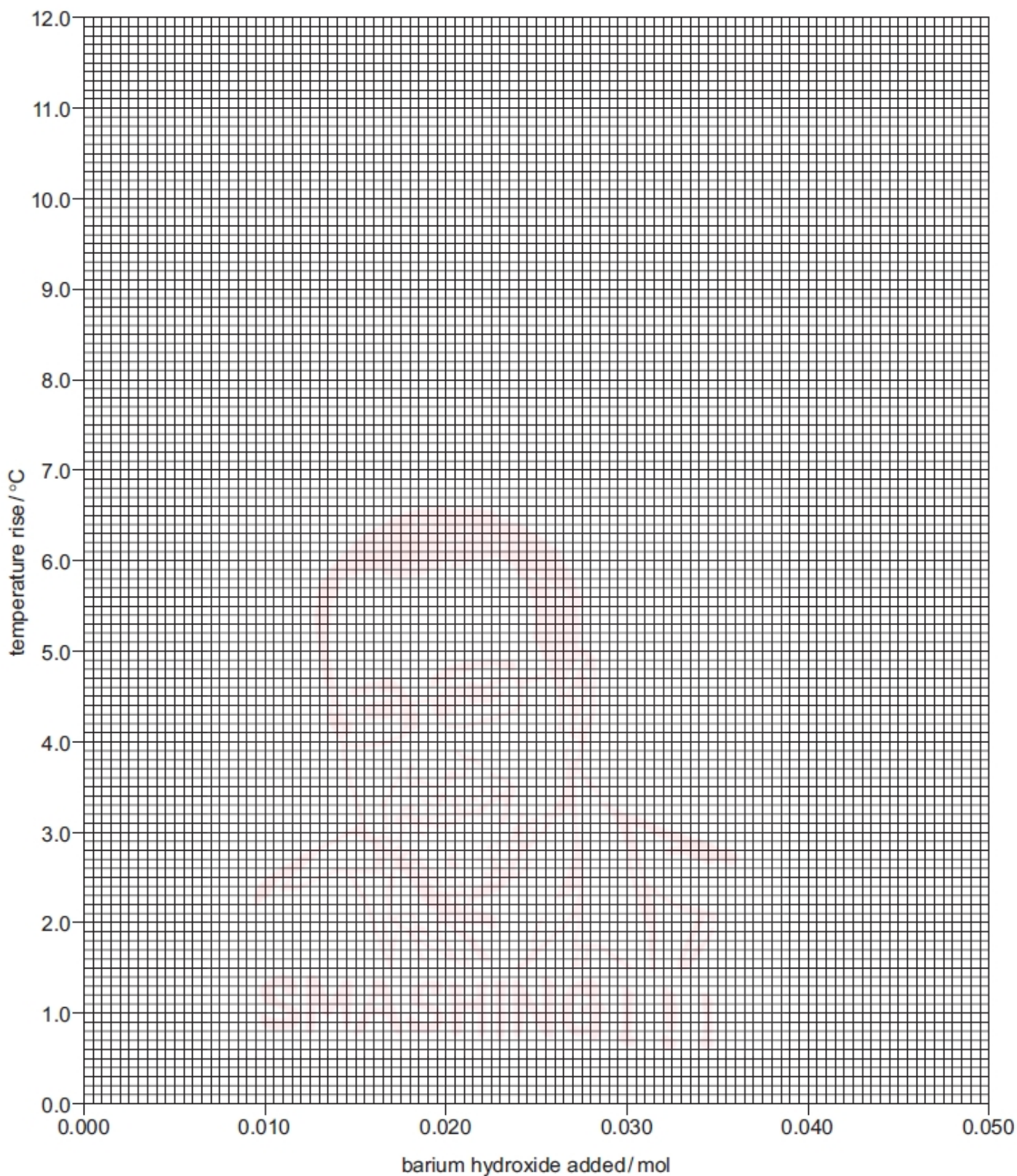

(ii) Draw **two** lines of best fit on your graph and state the value on the x-axis at the point of intersection of the two lines.

value on the x-axis at the point of intersection is [2]



Mark Scheme

Rate experiment MS

Topic Chem 4 Rate experiment MS Q# 1/ ALvl Chemistry/2019/w/TZ 1/ Paper 5/Q# 2/www.SmashingScience.org

2(a)	<p>M1: to remove (remaining) hydrochloric and nitric acid</p> <p>M2: to remove water / dry the tube</p>	2																																																						
2(b)	<table border="1"> <thead> <tr> <th>c</th> <th>$\frac{1}{c}$</th> <th>t</th> <th>$\frac{t}{t_0}$</th> <th>$\log \frac{t}{t_0}$</th> <th>$\frac{1}{c} \log \frac{t}{t_0}$</th> </tr> </thead> <tbody> <tr> <td>16.0</td> <td>0.0625</td> <td>176</td> <td>2.26</td> <td>0.354</td> <td>0.0221</td> </tr> <tr> <td>14.0</td> <td>0.0714</td> <td>164</td> <td>2.10</td> <td>0.322</td> <td>0.0230</td> </tr> <tr> <td>12.0</td> <td>0.0833</td> <td>151</td> <td>1.94</td> <td>0.288</td> <td>0.0240</td> </tr> <tr> <td>10.0</td> <td>0.100</td> <td>138</td> <td>1.77</td> <td>0.248</td> <td>0.0248</td> </tr> <tr> <td>8.0</td> <td>0.125</td> <td>125</td> <td>1.60</td> <td>0.204</td> <td>0.0255</td> </tr> <tr> <td>6.0</td> <td>0.167</td> <td>113</td> <td>1.45</td> <td>0.161</td> <td>0.0269 0.0268</td> </tr> <tr> <td>4.0</td> <td>0.250</td> <td>102</td> <td>1.31</td> <td>0.117</td> <td>0.0293</td> </tr> <tr> <td>2.0</td> <td>0.500</td> <td>89</td> <td>1.14</td> <td>0.0569</td> <td>0.0285</td> </tr> </tbody> </table> <p>M1: for column 2, $\frac{1}{c}$, to 3 SF</p> <p>M2: for column 5, $\log \frac{t}{t_0}$, to 3 SF</p> <p>M3: for column 6, $\frac{1}{c} \log \frac{t}{t_0}$, to 3 SF</p>	c	$\frac{1}{c}$	t	$\frac{t}{t_0}$	$\log \frac{t}{t_0}$	$\frac{1}{c} \log \frac{t}{t_0}$	16.0	0.0625	176	2.26	0.354	0.0221	14.0	0.0714	164	2.10	0.322	0.0230	12.0	0.0833	151	1.94	0.288	0.0240	10.0	0.100	138	1.77	0.248	0.0248	8.0	0.125	125	1.60	0.204	0.0255	6.0	0.167	113	1.45	0.161	0.0269 0.0268	4.0	0.250	102	1.31	0.117	0.0293	2.0	0.500	89	1.14	0.0569	0.0285	3
c	$\frac{1}{c}$	t	$\frac{t}{t_0}$	$\log \frac{t}{t_0}$	$\frac{1}{c} \log \frac{t}{t_0}$																																																			
16.0	0.0625	176	2.26	0.354	0.0221																																																			
14.0	0.0714	164	2.10	0.322	0.0230																																																			
12.0	0.0833	151	1.94	0.288	0.0240																																																			
10.0	0.100	138	1.77	0.248	0.0248																																																			
8.0	0.125	125	1.60	0.204	0.0255																																																			
6.0	0.167	113	1.45	0.161	0.0269 0.0268																																																			
4.0	0.250	102	1.31	0.117	0.0293																																																			
2.0	0.500	89	1.14	0.0569	0.0285																																																			
2(c)	<p>M1: all eight points plotted correctly</p> <p>M2: best-fit straight line drawn</p>	2																																																						
2(d)(i)	<p>M1: time will be greater / longer / flows more slowly (at a lower temperature)</p> <p>M2: solution is more viscous</p>	1 1																																																						
2(d)(ii)	use a controlled water bath (at 25 °C)	1																																																						
2(e)	point at (4.0, 0.0286) circled AND timer / (initial) time started too early / timer (final) time stopped too late	1																																																						
2(f)(i)	correctly extrapolates best-fit line to vertical intercept AND $\eta = \text{intercept} \times 2.30$	1																																																						
2(f)(ii)	<p>M1: $\log M_r = 1.59 \log \eta + 7.03$</p> <p>M2: $M_r = 1.48 \times 10^5$</p>	2																																																						
2(f)(iii)	<p>$M_r \div 104.0$</p> <p>$x = 1422$</p>	1																																																						

2(g)	<p>M1: a will be higher</p> <p>M2: poly(ethenol) and water form stronger / greater intermolecular forces (than between poly(phenylethene) with methyl benzene)</p> <p>OR</p> <p>poly(ethenol) and water form strong(er) hydrogen bonds (which were not present before)</p>	2
------	--	---

Topic Chem 8 **Rate experiment Q# 2/** ALvl Chemistry/2002/w/TZ 1/ Paper 5/Q# 1/www.SmashingScience.org

Question 1

(a) Accuracy

Comparing experiments 2 and 3.

The Examiner calculates for each experiment the value of **(Volume of FA 1 x time in seconds)**.
Record the values **above** the respective columns.
Subtract the smaller from the larger and then calculate:

$$\% \text{ Difference} = \frac{\text{Larger (Vxt)} - \text{Smaller (Vxt)}}{\text{Larger (Vxt)}} \times 100 \quad \text{(Record this \% on the script)}$$

Award accuracy marks as follows

(If the times for experiment 1 and experiment 2 differ by more than 10% of larger, work with the value that will give the better accuracy mark)

<i>% Difference</i>	<i>Mark</i>
Up to 5%	5
5+% to 10%	4
10+% to 15%	3
15+% to 20%	2
20+% to 30%	1

5

Comparing experiments 2 and 4.

(If the times for experiment 1 and experiment 2 differ by more than 10% of larger, work with the value that will give the better accuracy mark)

The Examiner calculates for each experiment the value of **(Volume of FA 2 x time in seconds)**.
Record the values **below** the respective columns.
Subtract the smaller from the larger and then calculate:

$$\% \text{ Difference} = \frac{\text{Larger (Vxt)} - \text{Smaller (Vxt)}}{\text{Larger (Vxt)}} \times 100 \quad \text{(Record this \% on the script)}$$

Award accuracy marks as follows

<i>% Difference</i>	<i>Mark</i>
Up to 5%	5
5+% to 10%	4
10+% to 15%	3
15+% to 20%	2
20+% to 30%	1

5



Compare experiments 2 and 3

- (b) (i) Give one mark for FA 2 (X) and FA 3 (Iodine), ignore water.
- (ii) Give one mark for FA 1 (Sulphuric acid), not water.
- (iii) Give one mark for a qualitative statement linking change in rate to changed volume/concentration of acid
- Give one mark for a semi-quantitative statement relating rate (not time) and volume/concentration that is **supported by the practical results**. To accept a statement that doubling the volume/concentration doubles the rate, a minimum of three marks must have been awarded for accuracy.
- Give one mark for a quantitative statement in mathematical form or a statement as to Order of Reaction that is **supported by the practical results**. To accept a statement of Rate \propto [Acid] or First Order (with respect to acid); a minimum of 3 marks must have been awarded for accuracy.

5

If FA 2 is given as the variable in b(ii) and FA 1 in c(ii); marks may still be awarded for b(iii) and c(iii) as the reaction is first order for each reagent.

Compare experiments 2 and 4

- (c) (i) Give one mark for FA 1 (Sulphuric acid) and FA 3 (Iodine), ignore water
- (ii) Give one mark for FA 2 (X), not water.
- (iii) Give one mark for a qualitative statement linking change in rate to changed volume/concentration of X
- Give one mark for a semi-quantitative statement relating rate (not time) and volume/concentration that is **supported by the practical results**. To accept a statement that doubling the volume/concentration doubles the rate, a minimum of three marks must have been awarded for accuracy.
- Give one mark for a quantitative statement in mathematical form or a statement as to Order of Reaction that is **supported by the practical results**. To accept a statement of Rate \propto [X] or First Order (with respect to X), a minimum of 3 marks must have been awarded for accuracy.

5

- (d) Give one mark if

$$\text{Volume of FA 1} = 20 \text{ cm}^3$$

$$\text{Volume of FA 2} = 20 \text{ cm}^3$$

$$\text{Volume of FA 3} < 4 \text{ cm}^3$$

$$\text{Volume of water} = (4.0 - \text{Volume of FA 3}) \text{ cm}^3$$

(Allow multiples of these volumes)

1

Total for Question 1

21

Award accuracy marks as follows:

6 Marks	5 Marks	4 Marks	3 Marks	2 Marks	1 Mark
All 3 Vt values within 5% of largest	2 Vt values within 5% of the larger of the closer pair Spread of all 3 values is \leq 10% of the larger of the 5% pair	2 Vt values within 5% of the larger of the closer pair Spread of all 3 values is \leq 20% of the larger of the 5% pair	2 Vt values within 5% of the larger of the closer pair Spread of all 3 values is \leq 25% of the larger of the 5% pair	2 Vt values within 5% of the larger of the closer pair Spread of all 3 values is \leq 40% of the larger of the 5% pair	
	All 3 Vt values within 7.5% of largest	2 Vt values within 7.5% of the larger of the closer pair Spread of all 3 values is \leq 12.5% of the larger of the 5% pair	2 Vt values within 7.5% of the larger of the closer pair Spread of all 3 values is \leq 20% of the larger of the 5% pair	2 Vt values within 7.5% of the larger of the closer pair Spread of all 3 values is \leq 30% of the larger of the 5% pair	Any 2 Vt values within 7.5% of the larger of the closer pair
		All 3 Vt values within 10% of largest	2 Vt values within 10% of the larger of the closer pair Spread of all 3 values is \leq 15% of the larger of the 5% pair	2 Vt values within 10% of the larger of the closer pair Spread of all 3 values is \leq 20% of the larger of the 5% pair	2 Vt values within 10% of the larger of the closer pair Spread of all 3 values is \leq 35% of the larger of the 5% pair
			All 3 Vt values within 12.5% of largest	2 Vt values within 12.5% of the larger of the closer pair Spread of all 3 values is \leq 17.5% of the larger of the 5% pair	2 Vt values within 12.5% of the larger of the closer pair Spread of all 3 values is \leq 30% of the larger of the 5% pair
				All 3 Vt values within 15% of largest	2 Vt values within 15% of the larger of the closer pair Spread of all 3 values is \leq 25% of the larger of the 5% pair
					All 3 Vt values within 17.5% of largest

[6]

Graph

Give **one mark** if $\lg\left(\frac{1000}{\text{time}}\right)$ is plotted on the y axis and $\lg(\text{volume of FB 1})$ on the x axis, both axes have been labelled (ignore units) **and** easily used linear scales with points plotted over 50% of each axis have been used. [1]

The Examiner is to check the plotting of the five points.

Give **two marks** if all five points (candidate's values) are plotted within $\frac{1}{2}$ small square (and in the correct small square), in either direction, of the point selected by the Examiner.

Deduct one mark for each point incorrectly plotted (no negative marks). [2]

Give **one mark** for a best-fit straight line.

If points are not in line or very close to being in line, the line of best fit must be drawn so as to 'cancel out' any discrepancies. The total distance (perpendicular to the drawn line) to the left should equal (as far as possible) the total distance to the right. If the candidate makes it clear that a point is being ignored this mark can be given for a line drawn through 4 points alone.

This mark is unlikely to be awarded where points are incorrectly plotted (or there has been error in calculation in Table 1.1). **If all the points are within a 4 adjacent squares, do not give this mark.** [1]

(c) Give **one mark** for stating that there is a constant (total) volume in each experiment. [1]

(d) Give **one mark** for stating that the volume of **FB 1** is proportional to its concentration (or equivalent statement).

Providing that a mark has been given in (c) or the candidate states in (d) that the total volume is kept constant -

Give **one mark** for $[\text{Na}_2\text{S}_2\text{O}_3]$ is directly proportional to. volume of **FB 1** or equivalent mathematical expression

There is no retrospective mark in (c) for a candidate who refers to constant (total) volume in (d)

[2]

(e) Give **one mark** for construction lines on the graph or graph extended to axes

Give **one mark** for numerical values (from the construction) used in a calculation

Give **one mark** for a suggested order that fits the experimental value. Do **not** give if calculation inverted. [3]

(f) Give **one mark** if the total volume of solution is 55 cm^3 in each experiment

Give **one mark** if the volume of **FB 1** is 40 cm^3 in each experiment

Penalise 1 mark if the volumes are exactly the same as in expt. 2.

Penalise 1 mark if volume of **FB2 is same in two or more experiments.**

Give **one mark** for correctly calculating $\left(\frac{1000}{\text{time}}\right)$ for both experiments 6 and 7.

Each answer must be correctly rounded to the significant figure shown (minimum is 2 s.f.) [3]

(g) Give **one mark** for a comment on rate (or time)/concentration of **HCl** that fits the experimental results.

[1]

[Total: 22]

Question	Sections	Indicative material	Mark	
1 (a)	(i) PLAN Problem	Uses collision theory to predict that the rate of formation of $H_2(g)$ increases as the concentration of HCl increases	[1]	
	(ii)	Uses collision theory to explain how rate of reaction increases with increasing temperature	[1]	[2]
(b)	PLAN Problem	<u>Concentration</u> of HCl identified as independent variable <i>[HCl] is acceptable</i>	[1]	[1]
(c)	PLAN Problem	States that the (total) volume of solution must be kept constant, or States that the amount/size/length/mass/surface area of the magnesium ribbon must be kept constant	[1]	[1]
(d)	(i) PLAN Methods	Lists apparatus for the reaction of $Mg/acid$, collection <u>and measurement</u> of gas and timing gas collection <i>Connecting tube does not need to be listed gas could be measured by full test-tube etc. A diagram is acceptable if a timing device is mentioned in the text</i>	[1]	
	(ii)	Dilutes a range of volumes of HCl sufficient for the experiment <i>A minimum of 5 different concentration solutions is required Total volume does not have to be constant</i>	[1]	
	(iii)	Prepares diluted solutions using measuring cylinder, pipette or burette	[1]	
	(iv)	Describes how collection of a stated volume of H_2 will be timed in each experiment, or Volume of H_2 collected in a stated time is described, or Volume of H_2 collected recorded at fixed intervals to enable graph to be plotted	[1]	
	(v)	Reference to the way in which total volume being kept constant, or temperature kept constant, or way in which other variable from (c) is controlled	[1]	

Question	Comments	Marking Material	Mark	
(vi)		<p>Candidate selects a range of suitable volumes of acid or states a range of concentrations to be used</p> <p><i>Volume of acid should cover the range from starting volume (concentration) to at least half the starting volume (concentration)</i></p> <p><i>Total volume must be constant <u>unless</u> a correct (relative) concentration has been given</i></p> <p><i>Ignore starting with a concentration of <u>less</u> than 2 mol dm^{-3} hydrochloric acid.</i></p>	[1]	
(vii)		<p><i>Do <u>not</u> accept concentrations greater than 2 mol dm^{-3}</i></p> <p>The plan is presented logically with an effective way of preventing loss of gas</p> <p><i>The use of dropping funnels or thistle funnels is permitted for addition of acid without loss of gas</i></p>	[1]	[7]
(e)	PLAN Methods	<p>Table has columns for</p> <p>volume of acid and volume of water, ***</p> <p>time (if fixed volume of gas is collected) <u>or</u></p> <p>volume of gas (if gas collected after fixed time)</p> <p><u>rate</u></p> <p><i>***Candidates may tabulate concentration instead of volume of acid and volume of water BUT TO QUALIFY FOR THIS MARK they must have shown numbers (volume of acid and volume of water) when describing a dilution in the text</i></p> <p>Each column shown has correct units</p> <p>Candidate explains the graph (<u>valid for the method described</u>) which is to be drawn <u>or</u></p> <p>the calculation to be performed <u>or</u></p> <p>how the volume of gas – collected at fixed time interval <u>or</u></p> <p>time – for collection of a fixed volume of gas will provide information in support of or against the prediction in (a)(i)</p> <p><i>Examiners will expect increased concentration/increased rate</i></p> <p>or</p> <p><i>larger volume in fixed time linked to higher concentration</i></p> <p><i>shorter time for fixed volume linked to higher concentration</i></p> <p><i>(or reverse argument)</i></p>	[1]	
			[1]	
			[1]	[3]
(f)	PLAN Methods	<p>Candidate repeats the experiment keeping HCl constant and varying the temperature</p> <p>Description of how the temperature will be <u>controlled</u> is required</p>	[1]	[1]

2 (b)	ACE Evaluation ACE Evaluation	Data at either 5.0 or 7.5 minutes identified (Ignore any other point) and suggests one of the following 1. irregular movement of syringe (sticking), 2. H ₂ gas lifts Mg out of the acid solution, 3. reading taken <u>before indicated time</u> .	1
2 (c)	ACE Data	Constructs initial "tangent". Accept either of the following; 1. an attempted tangent to the curve at (t = 0), 2. a straight line drawn through the plotted points at 0.5, 1.0, 1.5 and 2.0 minutes. Reads coordinates <u>from any tangent</u> correct to ½ small square in either direction from the tangent and uses the coordinates in a correct <u>expression</u> for the gradient.	1 1
2 (d)	ACE Evaluation	Award the mark for either of the following; 1. stopwatch started after magnesium ribbon dropped into flask, (flask sealed and gas collected), 2. gas pushed into the syringe when inserting the bung.	
2 (e)	ACE Conclusions	Identifies as a further source of error one of the following – and gives an <u>appropriate</u> method of reducing the error; 1. gas collected before timing starts or gas pushed into syringe when bung inserted – if not already given in (d) , 2. use of 500 cm ³ measuring cylinder to measure 100 cm ³ of acid, 3. 0.01 g of magnesium weighed on a balance weighing to 2 decimal places. 4. loss of gas before the bung is inserted	1
2 (f)	ACE Data	Calculates relative concentration of acid in each mixture. (See appendix) (1 or 2 sig fig acceptable) (N.B. not all of the experiments have a total volume of 100 cm ³)	1

2 (g)	ACE Data	Plots initial rate v relative concentration with appropriate labels, units and scales. Scales – points must be plotted over $\frac{1}{2}$ length of each available axis. Do not penalise “awkward” scales.	1
		Points <u>for students 3 4 and 8</u> correctly plotted and no others obviously wrong <i>Points plotted to $\frac{1}{2}$ small square in either direction and within correct half square</i>	1
		Straight line drawn through points for students 2 – 8. <i>Does not have to pass through 0,0. The straight line should have points either side of the line.</i>	1
2 (h)	ACE Conclusions	Concludes that prediction is wrong for a straight line (or right for a curve) and refers to the shape of the graph.	1
		Only give this mark if the candidate has drawn a straight line through the points in (g) Concludes one of the following: 1. the rate of reaction = $k[\text{HC}l]$, 2. reaction is first order wrt $\text{HC}l$, 3. reaction is directly proportional to $[\text{HC}l]$ <i>(even if straight line does not pass through 0,0),</i> 4. the graph/line for a 2 nd order reaction would be a curve/parabola.	1
2 (i)	ACE Evaluation	Award this mark for any answer that is acceptable for the points plotted, line drawn by the candidates. <i>If the data has been correctly processed there should be a good distribution of points for a best-fit straight line.</i> Ignore student 1 – unless the candidate refers to this point. <i>If the relative concentration has been calculated to only 1 significant figure there is lower confidence in the point plotted for Student 2.</i>	1
		Question 2 Total	14

Question 2 (f)

student	volume of acid used / cm ³	volume of water used / cm ³	mass of magnesium / g	initial rate / cm ³ min ⁻¹	relative concentration of acid	
1	100	0	0.01		1.0	1.0
2	45	55	0.01	8.0	0.45	0.5
3	90	10	0.01	16.4	0.90	0.9
4	60	40	0.01	11.5	0.60	0.6
5	100	100	0.01	9.3	0.50	0.5
6	35	75	0.01	6.8	0.35	0.4
7	80	20	0.01	15.2	0.80	0.8
8	60	240	0.01	3.3	0.20	0.2
					2 sig fig	1 sig fig



1 (a)	PLAN Problem	Treat section (a) as one answer. From preliminary expt – predicts that rate of reaction will be proportional to [persulfate] / accept 'doubling the concentration doubles the rate'/increasing concentration increases rate. Explains that doubling the concentration doubles the number of collisions/increasing the concentration increases the number of collisions. The use of frequency alone is incorrect but if used with other correct comments regard it as neutral.	[1] [1]
(b)	PLAN Problem	(i) [Persulfate] as independent variable. Accept the correct ion instead of the correct name. Do not accept volume or amount. (ii) Elapsed time identified as dependent variable / rate (of reaction) or equivalent. Time alone scores zero but rate alone is OK.	[1] [1]
(c)	PLAN Problem	Explains that [iodide] remains constant – (controlled variable)/so that the iodide does not run out/continuous supply of iodide ions (for reaction with persulfate). NOT allowed are reformed/regenerated alone – rubric.	[1]
(d)	PLAN Methods	(i) Has at least 3 more appropriate experiments of lower concentration. (inappropriate experiments negate this mark) (ii) At least one of the diluted (varying water or persulphate) solutions half or less of original <u>correct</u> concentration / uses 20 cm ³ or less of persulphate at least once. (if concentration is used alone it must be correct but if used in conjunction with volumes regard the concentration as neutral). (iii) Total volume, volumes of potassium iodide, thiosulfate and starch all constant. (allow drops of starch) (use of the exemplar experiment is not mandatory) If all volumes stated, then the same procedure (with different persulfate concentrations) repeated could suffice. (iv) Burette or measuring cylinder used to measure volumes of persulfate <u>and</u> distilled water. (v) 'Minimum' is persulfate and iodide kept apart until reaction stated as started. (vi) Clock stopped when blue colour appears / elapsed time to blue colour is noted / measure time to the appearance of the blue colour. Not in a (timed) titration procedure. <u>Also look at the table in (f) for possible answers to the first three marks.</u>	[1] [1] [1] [1] [1] [1]
(e)	PLAN Methods	<u>Explains</u> that the volume / amount of thiosulfate defines the extent of the reaction ("finishing line") to enable comparison – or equivalent statement. Relate the constant volume of thiosulphate to the end / finishing point. Any reference to 'accuracy' should be regarded as neutral'.	[1]

(f)	PLAN Methods	Tabulates volumes or concentrations of persulfate. (<i>Accept concentration if volumes used in text to show diluted solution</i>) and elapsed time. Include unit Includes a column for rate or Vt and unit (cm^3s), or concentration $\times t$ and unit. (<i>Penalise error or omission in units once only across the three relevant columns</i>) Units for rate (or $1/t$) should be s^{-1} or $\text{mol dm}^{-3}\text{s}^{-1}$. allow 'brackets instead of /'. (NOT M seconds minutes)	[1] [1]
(g)	PLAN Methods	Must have the first mark in (a). Mark "justification" consequently. 'If the rate increases/time decreases/ Vt is constant as the concentration of persulfate increases then the rate is proportional to the concentration of the persulfate'. Check the trend in (f) from time/rate and conc/vol data that may be provided. Accept a plot of rate against concentration having a line of positive slope/or going through the origin, OR a plot of time against concentration having a line of negative slope.	[1]
Qn 1	Total		[15]

Topic Chem 8 **Rate experiment Q# 7/** ALvl Chemistry/2017/w/TZ 1/ Paper 5/Q# 1/www.SmashingScience.org

Question	Answer	marks
1(a)(i)	mass = $228.2 \times 1.00 \times (250/1000)$ = 57.1 g	1
1(a)(ii)	Distilled/deionised water must be mentioned somewhere for 2 marks to be given. Dissolve (all) the solid in a (suitable container) with (distilled) water	1
	Transfer / add to a 250 cm^3 volumetric flask AND make to mark with (distilled) water	1
1(a)(iii)	(starch) gives a sharp 'end-point' / turns blue sharply / goes blue with volume of I_2 invisible to naked eye	1
1(b)	volumes of $(\text{NH}_4)_2\text{S}_2\text{O}_8(\text{aq})$ constant	1
	volumes of I^- varying with range	1
	total volume constant, made up by water	1
1(c)(i)	mol $\text{I}_2(\text{aq}) = V(\text{S}_2\text{O}_3^{2-}) \times [\text{S}_2\text{O}_3^{2-}] / 2$ = $\left(\frac{0.005 \times 0.0050}{2} \right) = 1.25 \times 10^{-5}$	1
	$[\text{I}_2(\text{aq})] = \frac{\text{moles of } \text{I}_2(\text{aq})}{V_{\text{total}}} = \frac{1.25 \times 10^{-5}}{0.021} = 5.95 \times 10^{-4}$	1
	rate = $[\text{I}_2(\text{aq})] / \text{time}$ = $\frac{5.95 \times 10^{-4}}{134} = 4.44 \times 10^{-6}$	1
1(c)(ii)	repeat the experiment (and take average)	1
1(c)(iii)	% error = $\frac{2 \times 0.05}{5.0} \times 100\% = 2.0\%$	1

1(d)	No thiosulfate had been added	1
1(e)	Ammonium persulfate must be stated along with its hazard and linked to the precaution. Ammonium persulfate is a skin irritant so wear gloves OR Ammonium persulfate is an irritant to the respiratory system; do the experiment in fume cupboard/face mask OR Ammonium persulfate is harmful if swallowed so avoid mouth contact/wear face mask OR Ammonium persulfate is oxidising so avoid contact with flammable/combustible materials. OR Ammonium persulfate is harmful/hazardous to the environment so do not dispose of down the drain/use (large quantities) of water to dilute before disposal	1

Topic Chem 8 **Rate experiment Q# 8/** ALvl Chemistry/2020/m/TZ 2/ Paper 5/Q# 2/www.SmashingScience.org

2(a)	measure the final temperature (and take average)	1																														
2(b)	<table border="1"> <thead> <tr> <th>experiment number</th> <th>average temperature</th> <th>time</th> <th>$\frac{1}{T}$</th> <th>log t</th> </tr> </thead> <tbody> <tr> <td>1</td> <td>333</td> <td>11</td> <td>0.00300</td> <td>1.04</td> </tr> <tr> <td>2</td> <td>323</td> <td>35</td> <td>0.00310</td> <td>1.54</td> </tr> <tr> <td>3</td> <td>315</td> <td>76</td> <td>0.00317</td> <td>1.88</td> </tr> <tr> <td>4</td> <td>310</td> <td>145</td> <td>0.00323</td> <td>2.16</td> </tr> <tr> <td>5</td> <td>304</td> <td>284</td> <td>0.00329</td> <td>2.45</td> </tr> </tbody> </table> <p>M1 1/T values M2 log t values</p>	experiment number	average temperature	time	$\frac{1}{T}$	log t	1	333	11	0.00300	1.04	2	323	35	0.00310	1.54	3	315	76	0.00317	1.88	4	310	145	0.00323	2.16	5	304	284	0.00329	2.45	2
experiment number	average temperature	time	$\frac{1}{T}$	log t																												
1	333	11	0.00300	1.04																												
2	323	35	0.00310	1.54																												
3	315	76	0.00317	1.88																												
4	310	145	0.00323	2.16																												
5	304	284	0.00329	2.45																												
2(c)	time is short so greater percentage error	1																														
2(d)	time	1																														
2(e)	M1 5 points plotted correctly M2 line of best fit drawn	2																														
2(f)(i)	M1 co-ordinates read and recorded correctly M2 gradient calculated to three significant figures	2																														
2(f)(ii)	M1 gradient $\times 2.303 \times 8.314$ correctly calculated M2 units (J mol^{-1} or kJ mol^{-1})	2																														

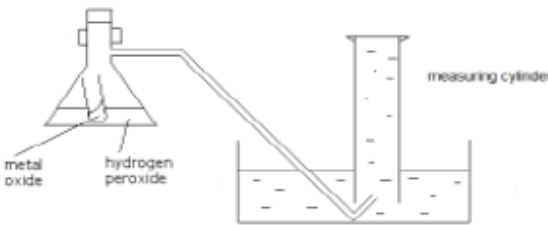
1(a)(i)	the metal oxide	1
1(a)(ii)	count bubbles in a set time OR measure volume (of oxygen) in a certain time OR measure time to produce a certain volume	1
1(b)	<i>Any two from:</i> the volume of the hydrogen peroxide / solution the concentration of the hydrogen peroxide temperature particle size	2
1(c)	correctly drawn diagram showing:  M1: contents of flask M2: sealed apparatus M3: collection of the gas in a measuring cylinder (graduations assumed) (via a delivery tube into water) / gas syringe	3
1(d)(i)	volume of gas / oxygen AND time	1
1(d)(ii)	plot a (volume / time) graph AND measure gradient / produce a tangent at $t = 0$ or at the start	1
1(e)	repeat (the experiments / trials) (until consistent results)	1
1(f)	measuring the decrease / change in (total) mass of the solution / mixture / reaction vessel (and contents) (and time) OR measuring the mass / weight of the mixture/reaction vessel (and contents) AND time	1
1(g)	M1: (filter/remove) dry the residue/metal oxide M2: weigh the residue / metal oxide to see if the mass is unchanged OR M1: re-use with new hydrogen peroxide / do the same reaction again with the same catalyst M2: and check if the gas volumes identical / rate of reaction the same	2
1(h)	to allow the oxygen / gas (that is formed) to be released / escape / diffuse out	1

Page 1	Mark Scheme	Syllabus	Paper
	A LEVEL – NOVEMBER 2004	9701	5

1 Table of results - Table 1.1

Give **one** mark if all times are given to the nearest second.

Do **not** give this mark if timings are given to 0.1 or 0.01 s

Do **not** give this mark if the stop-clock has been read as minute.second e.g. 1.07

The Examiner:

Rounds all times to the nearest second if necessary, and

Converts times that are clearly in minute.second format to seconds. e.g. 1.07 becomes 67 s

(The shortest time recorded should be approaching 60 seconds).

1

Accuracy Marks

For each of the Experiments 1 - 3 a (volume x time) value is calculated.

For *Experiment 1*, the Examiner calculates (50 x time in seconds)

Record this value in the margin to the left of Table 1.1 and alongside *Experiment 1*.

For *Experiment 2*, the Examiner calculates (40 x time in seconds)

Record this value in the margin to the left of Table 1.1 and alongside *Experiment 2*.

For *Experiment 3*, the Examiner calculates (30 x time in seconds)

Record this value in the margin to the left of Table 1.1 and alongside *Experiment 3*.

Accuracy marks for reactions where the $[\text{BrO}_3^-]$ is changed

Calculate the difference between the (V x t) values for *Experiments 1 and 2*.

Calculate $\frac{\text{difference in Vt values}}{\text{larger Vt used in calculating difference}} \times 100$

Record both Vt and % difference below Table 1.1

Assign accuracy marks as follows:

Difference	Mark
Up to 4%	5
4+% to 5%	4
5+% to 6%	3
6+% to 8%	2
8+% to 10%	1
Greater than 10%	0

IT IS RECOMMENDED THAT EXAMINERS RECORD THE EXPRESSION FOR EACH % DIFFERENCE ON THE SCRIPT

5

Accuracy marks for reactions where the $[Br^-]$ is changed

Calculate the difference between the $(V \times t)$ values for *Experiments 1 and 3* and for *Experiments 2 and 3*.

For each pair of experiments – calculate

$$\frac{\text{difference in } Vt \text{ values}}{\text{larger } Vt \text{ used in calculating difference}} \times 100$$

Record Vt and % difference for each pair below Table 1.1

Assign accuracy marks as follows for the smaller of the two % differences:

Difference	Mark
Up to 5%	5
5+% to 7%	4
7+% to 10%	3
10+% to 15%	2
15+% to 20%	1
Greater than 20%	0

5

IF A SPREADSHEET IS USED TO GENERATE Vt VALUES, Vt DIFFERENCES, % DIFFERENCES AND MARKS, DOUBLE CHECK THE EXPERIMENT TIMES ENTERED FOR EACH CANDIDATE

(b) Give **one mark** for one of the following ideas:

Total volume is constant so that reagent volume is \propto concentration of reagent

Total volume is constant so that (individual) volumes represent or are a measure of concentration

Total volume is constant so that in any pair of experiments only one concentration is varied

The concentration of phenol remains constant 1

In (c) to (e) when calculating the appropriate order of reaction from the candidate's results, allow fractional/decimal orders or the calculated order rounded to the nearest whole number.

(c) The effect on the rate of reaction when $[\text{BrO}_3^-]$ is changed

Give **one mark** for a comparison of the volumes of BrO_3^- used for Experiments 1 and 2.

Give **one mark** for a comparison of the calculated rates of reaction for Experiments 1 and 2.

Give **one mark** for linking the volume ratio to rate ratio to suggest an appropriate order of reaction.

N.B. There must be use of experimental values and calculation to gain these marks. 3

(d) The effect on the rate of reaction when $[\text{Br}^-]$ is changed

Give **one mark** for a comparison of the volumes of Br^- used for Experiments 1 and 3.

Give **one mark** for a comparison of the calculated rates of reaction for Experiments 1 and 3.

Give **one mark** for linking the volume ratio to rate ratio to suggest an appropriate order of reaction.

N.B. There must be use of experimental values and calculation to gain these marks. 3

Where candidates use compare V_t values to establish order, give 1 mark for each V_t value, correctly calculated for the appropriate experiment and 1 mark for order statement from the V_t values.

(e) The effect on the rate of reaction when $[H^+]$ is changed

Give one mark for selection of experiment 3 and experiment 4.

Providing experiments 3 and 4 have been selected

Give one further mark for a calculation that compares the volumes of acid used and also compares the calculated rates.

(Most text-books give the reaction as 2nd order with respect to acid - expect to see rate increasing x 3 when the concentration of acid is doubled.) 2

Total for Question 1 = 20

Topic Chem 26 **Rate experiment Q# 11/** ALvl Chemistry/2011/w/TZ 1/ Paper 5/Q# 2/www.SmashingScience.org

Question	Sections	Indicative material	Mark
2 (a)	ACE Data	Log ₁₀ (rate) or Log ₁₀ (1/time) or Log ₁₀ (1/t). One of these labels also serves as expression, full column no units. Accept log with no base.	[1]
		Reciprocal absolute temperature or reciprocal Kelvin temperature or 1/T (not temp etc.). One of these labels also serves as expression, full column with unit, K ⁻¹ . Don't accept 1/T × 10 ⁻³ /K ⁻¹ but /10 ⁻³ K ⁻¹ OK	[1]
		Data in both columns above to 3 sig figs and correct, allow 2 errors.	[1]
		Allow salvage mark for rate column if ALL correct. A heading of 1/time or 1/t or 1/C also serves as expression.	
(b)	ACE Data	Unambiguously labelled axes. 1/T on the x-axis and log ₁₀ (rate) on the y axis AND appropriate scaling. Ignore units unless it is the label.	[1]
		Correctly plotted points. Ecf incorrectly calculated data. All 10 points need to be plotted. Check points 3 & 7 and 1 & 10 and any others off the line.	[1]
		Line of best fit.	[1]
		Allow plot and line marks if other axes used.	

2 (a)	ACE Data	<p>Correct log column heading as $\log C/\log(a-x)/\log(1-B)$.</p> <p>Calculations for the log column in the table below are correct and given to 3 sig figs. (Allow 1 error without penalty.)</p> <table border="1" data-bbox="552 338 1347 763"> <thead> <tr> <th>A</th> <th>B</th> <th>C</th> <th>D</th> </tr> <tr> <td></td> <td></td> <td>$1 - B / \text{mol dm}^{-3}$</td> <td>$\log C$</td> </tr> </thead> <tbody> <tr> <td>0</td> <td>0.000</td> <td>1</td> <td>0</td> </tr> <tr> <td>30</td> <td>0.101</td> <td>0.899</td> <td>- 0.0462</td> </tr> <tr> <td>60</td> <td>0.193</td> <td>0.807</td> <td>- 0.0931</td> </tr> <tr> <td>100</td> <td>0.259</td> <td>0.741</td> <td>- 0.130</td> </tr> <tr> <td>130</td> <td>0.370</td> <td>0.630</td> <td>- 0.201</td> </tr> <tr> <td>180</td> <td>0.469</td> <td>0.531</td> <td>- 0.275</td> </tr> <tr> <td>210</td> <td>0.551</td> <td>0.449</td> <td>- 0.348</td> </tr> <tr> <td>240</td> <td>0.573</td> <td>0.427</td> <td>- 0.370</td> </tr> <tr> <td>270</td> <td>0.617</td> <td>0.383</td> <td>- 0.417</td> </tr> <tr> <td>300</td> <td>0.655</td> <td>0.345</td> <td>- 0.462</td> </tr> </tbody> </table>	A	B	C	D			$1 - B / \text{mol dm}^{-3}$	$\log C$	0	0.000	1	0	30	0.101	0.899	- 0.0462	60	0.193	0.807	- 0.0931	100	0.259	0.741	- 0.130	130	0.370	0.630	- 0.201	180	0.469	0.531	- 0.275	210	0.551	0.449	- 0.348	240	0.573	0.427	- 0.370	270	0.617	0.383	- 0.417	300	0.655	0.345	- 0.462	<p>[1]</p> <p>[1]</p>
A	B	C	D																																																
		$1 - B / \text{mol dm}^{-3}$	$\log C$																																																
0	0.000	1	0																																																
30	0.101	0.899	- 0.0462																																																
60	0.193	0.807	- 0.0931																																																
100	0.259	0.741	- 0.130																																																
130	0.370	0.630	- 0.201																																																
180	0.469	0.531	- 0.275																																																
210	0.551	0.449	- 0.348																																																
240	0.573	0.427	- 0.370																																																
270	0.617	0.383	- 0.417																																																
300	0.655	0.345	- 0.462																																																
(b)	ACE Data	<p>Both axes scaled from zero with x-axis labelled as 'time /min' and y-axis as $\log C$. Plotted points must cover at least half the grid in both directions.</p> <p>All nine points plotted correctly. (Allow tolerance of \pm of $\frac{1}{2}$ small square.)</p> <p>Appropriate straight line drawn through the origin. (If all points do not lie on the line then the net deviation of the non-anomalous points on each side of the best fit line must be approximately the same.)</p>	<p>[1]</p> <p>[1]</p> <p>[1]</p>																																																
(c)	ACE Evaluation	<p>2 anomalous points circled at time 100 min and 210 min.</p> <p>$t = 100$ min – sample taken out too early OR recorded time is later than sample withdrawn. $t = 210$ min – sample taken out too late OR recorded time is earlier than sample withdrawn.</p>	<p>[1]</p> <p>[2]</p>																																																
(d)	ACE Evaluation	<p>Most of the points are on the line OR only a few points are not on the line OR there are only a few anomalies.</p>	<p>[1]</p>																																																
(e)	ACE data	<p>Appropriately drawn lines on the graph.</p> <p>Correctly read values from the graph. (If no construction lines shown, allow values from the table if graph drawn does actually go through point(s) used.)</p> <p>Correctly calculated value of the slope given to 3 sig figs with correct unit (min^{-1}) using the candidate's figures.</p>	<p>[1]</p> <p>[1]</p> <p>[1]</p>																																																
(f)	ACE Conclusion	<p>Statement that the relationship is justified since a straight line is produced.</p>	<p>[1]</p>																																																

(g)	ACE Conclusion	Draws a straight line from the origin with a different gradient.	[1]
		Shows shorter elapsed times. (Steeper gradient)	[1]
	Total		[15]

Topic Chem 26 **Rate experiment Q# 13/** ALvl Chemistry/2016/m/TZ 2/ Paper 5/Q# 1/www.SmashingScience.org

question	expected answer	mark
1 (a)	<p>M1 (apparatus mark) volumetric flask in range 25–250cm³;</p> <p>M2 mol propanone = 1.00 × (flask volume / 1000); e.g. mol of propanone = 1.00 × 25 / 1000 = 0.025 mol</p> <p>M3 M2 × 58.0; e.g. 0.025 × 58.0 = 1.45g</p>	[3]
(b) (i)	B must be added before first or second reactant	[1]
(ii)	the reactants are A and C so one of these must be mixed last; or the reaction must not start before all three substances are present;	[1]
(c) (i)	(10 cm ³) pipette	[1]
(ii)	M1 NaHCO ₃ will effervesce so when effervescence finishes it shows that all H ⁺ ions have been removed; M2 NaOH will react with I ₂ / CH ₃ COCH ₃ / reactants;	[2]
(d) (i)	<p>M1 mol I₂ = (10 / 100) × 0.200 × (50 / 1000) = 1.(00) × 10⁻³ mol;</p> <p>M2 mol S₂O₃²⁻ = 2 × 1.00 × 10⁻³ = 2.(00) × 10⁻³ mol;</p> <p>M3 volume 0.100 mol dm⁻³ S₂O₃²⁻ = (1000 × 2.00 × 10⁻³) / 0.100 = 20(.0) cm³;</p>	[3]
(ii)	indicator = starch; colour change = blue-black to colourless;	[2]
(e)	time and units of s; volume of thiosulfate and units of cm ³ ;	[2]
(f)	temperature;	[1]
(g) (i)	<p>M1 (labels) x-axis = time y-axis = concentration of iodine</p> <p>M2 curved line decreasing from left to right starting from x = 0</p>	[2]

(ii)	idea of constant half-life: determine at least two half-lives from the graph and ensure that they are the same; or half-lives determined from the graph should be constant; or determine the gradient (rate) at different points on the graph and plot rate v. concentration to determine if the plot is linear and goes through the origin;	[1]
(h)	(incorrect and) half-life will still be constant; or temperature has no effect upon order (of reaction);	[1]

Topic Chem 26 **Rate experiment Q# 14/** ALvI Chemistry/2016/s/TZ 1/ Paper 5/Q# 2/www.SmashingScience.org

2 (a)	<table border="1"> <thead> <tr> <th>$1/T/K^{-1}$</th> <th>$\log_{10}(1/t)$</th> </tr> </thead> <tbody> <tr> <td>3.47×10^{-3}</td> <td>-1.92</td> </tr> <tr> <td>3.41×10^{-3}</td> <td>-1.76</td> </tr> <tr> <td>3.33×10^{-3}</td> <td>-1.56</td> </tr> <tr> <td>3.30×10^{-3}</td> <td>-1.45</td> </tr> <tr> <td>3.26×10^{-3}</td> <td>-1.25 or -1.26</td> </tr> <tr> <td>3.22×10^{-3}</td> <td>-1.28</td> </tr> <tr> <td>3.19×10^{-3}</td> <td>-1.18</td> </tr> <tr> <td>3.16×10^{-3}</td> <td>-1.08</td> </tr> <tr> <td>3.12×10^{-3}</td> <td>-0.95</td> </tr> <tr> <td>3.05×10^{-3}</td> <td>-0.90</td> </tr> </tbody> </table>	$1/T/K^{-1}$	$\log_{10}(1/t)$	3.47×10^{-3}	-1.92	3.41×10^{-3}	-1.76	3.33×10^{-3}	-1.56	3.30×10^{-3}	-1.45	3.26×10^{-3}	-1.25 or -1.26	3.22×10^{-3}	-1.28	3.19×10^{-3}	-1.18	3.16×10^{-3}	-1.08	3.12×10^{-3}	-0.95	3.05×10^{-3}	-0.90	
	$1/T/K^{-1}$	$\log_{10}(1/t)$																						
	3.47×10^{-3}	-1.92																						
	3.41×10^{-3}	-1.76																						
	3.33×10^{-3}	-1.56																						
	3.30×10^{-3}	-1.45																						
	3.26×10^{-3}	-1.25 or -1.26																						
	3.22×10^{-3}	-1.28																						
	3.19×10^{-3}	-1.18																						
	3.16×10^{-3}	-1.08																						
	3.12×10^{-3}	-0.95																						
	3.05×10^{-3}	-0.90																						
Column values for $1/T$ correctly calculated	[1]																							
Column values for $\log_{10}(1/t)$ correctly calculated	[1]																							
3sf in $1/T$ AND 2 dp in $\log_{10}(1/t)$	[1]																							
(b)	candidate's points plotted correctly from table in 2(a)	[1]																						
	line of best fit drawn	[1]																						

(c)	<p>Two anomalies identified</p> <p>Reasons: Points to the left of the line: the time of disappearance was thought to be later OR the time was stopped too late (after reaction ended) OR the (hydrochloric acid) solution had not reached the temperature of the water bath OR the timer was started early OR magnesium folded up (reduced surface area)</p> <p>Points to the right of the line: the Mg may have been thought to have disappeared earlier than it did OR the timer was started late OR the timer was stopped too early (reaction still going)</p>	[1]
(d) (i)	<p>two co-ordinates in correct x, y format</p> <p>gradient calculated correctly from candidate's stated co-ordinates (the value MUST be negative unless the graph is mis-plotted)</p> <p>value MUST be to 3 significant figures</p> <p>Expected range -2500 to -3500</p>	[1]
(ii)	<p>$-E_A = \text{gradient} \times 0.0191$ OR $-E_A = \text{gradient} \times 0.0191$ then divide by 1000 OR correct transformations</p> <p>correct calculation and sign from candidate's gradient, gradient may be in calculation form, minimum 2 significant figures</p>	[1]
(e)	<p>valid answer dependent on candidate's graph, e.g. reliable because most of the points on/ close to the line OR unreliable as most points not on the line</p>	[1]
(f)	<p>Student X is correct; reaction time less OR reaction is faster AND percentage error/ uncertainty will be greater OR greater error/ uncertainty in time/ data/ recordings</p>	[1]
(g)	<p>reaction time is longer/ rate slower AND some of the magnesium is not in contact (with the acid) OR less surface area for reaction (with HCl) OR only the bottom of the magnesium is reacting</p>	[1]
(h)	<p>initial rate lower /slower. AND the concentration of H^+ ions is lower/ pH higher OR ethanoic acid less dissociated/ weaker acid</p>	[1]
		[15]

2(a)	Column C data correct Column D data correct and given to 2 dp	1 1	2																																				
	<table border="1"> <thead> <tr> <th>C</th> <th>D</th> <th></th> </tr> </thead> <tbody> <tr> <td>$(\alpha - \alpha_{\infty})$</td> <td>$\log_{10}(\alpha - \alpha_{\infty})$</td> <td>time</td> </tr> <tr> <td>51.9</td> <td>1.72</td> <td>0</td> </tr> <tr> <td>41.1</td> <td>1.61</td> <td>300</td> </tr> <tr> <td>33.3</td> <td>1.52</td> <td>600</td> </tr> <tr> <td>27.5</td> <td>1.44</td> <td>900</td> </tr> <tr> <td>22.6</td> <td>1.35</td> <td>1200</td> </tr> <tr> <td>18.2</td> <td>1.26</td> <td>1500</td> </tr> <tr> <td>14.4</td> <td>1.16</td> <td>1800</td> </tr> <tr> <td>11.7</td> <td>1.07</td> <td>2100</td> </tr> <tr> <td>9.5</td> <td>0.98</td> <td>2400</td> </tr> <tr> <td>7.5</td> <td>0.88</td> <td>2700</td> </tr> </tbody> </table>	C		D		$(\alpha - \alpha_{\infty})$	$\log_{10}(\alpha - \alpha_{\infty})$	time	51.9	1.72	0	41.1	1.61	300	33.3	1.52	600	27.5	1.44	900	22.6	1.35	1200	18.2	1.26	1500	14.4	1.16	1800	11.7	1.07	2100	9.5	0.98	2400	7.5	0.88	2700	
	C	D																																					
	$(\alpha - \alpha_{\infty})$	$\log_{10}(\alpha - \alpha_{\infty})$		time																																			
	51.9	1.72		0																																			
	41.1	1.61		300																																			
	33.3	1.52		600																																			
	27.5	1.44		900																																			
	22.6	1.35		1200																																			
	18.2	1.26		1500																																			
	14.4	1.16		1800																																			
	11.7	1.07		2100																																			
	9.5	0.98		2400																																			
7.5	0.88	2700																																					
2(b)(i)	All ten points plotted correctly Best-fit straight line drawn	1 1	2																																				
2(b)(ii)	(Yes) most of the points are on the line OR only a few points are not on the line	1	1																																				
2(c)(i)	Co-ordinates read and recorded correctly Correctly calculated value of the gradient given to 3sf and using the candidate's co-ordinates correctly	1 1	2																																				
2(c)(ii)	$k = \text{candidate's gradient} \times (-2.30)$ Correct answer	1 1	2																																				
2(d)(i)	Reading / value of α was read / taken / recorded too early	1	1																																				
2(d)(ii)	Two co-ordinates on line correctly read and stated AND One y value must be half the other $t_{1/2}$ correctly determined from candidate's co-ordinates values provided $y_1 = y_2/2$	1 1	2																																				
2(d)(iii)	Correctly calculated value for $k' = \frac{0.693}{t \frac{1}{2}}$	1	1																																				
2(d)(iv)	Second reaction took place at <u>higher</u> temperature AND because k' (second k value) is larger	1	1																																				
2(d)(v)	No OR the half-life would not change AND half-life is independent of concentration OR the reaction is first order (with respect to sucrose)	1	1																																				
Total:			15																																				



2(a)	Water bath/beaker of water containing thermometer around flask	1																																												
	Controlled heat source or heater/temperature regulator	1																																												
2(b)(i)	Moles $N_2 = 72 / 24\,000 = 0.003$ moles (1 mol $C_6H_5N_2^+Cl^- \rightarrow 1$ mol N_2)	1																																												
	Moles $C_6H_5N_2^+$ in 1000 cm^3 solution = $0.003 \times (1000 / 200) = 1.50 \times 10^{-2}$ (mol)	1																																												
2(b)(ii)																																														
	Axes (label with quantity or correct unit) and values correct	1																																												
	Straight line from axis marks OR from 0,0 over most of the axes	1																																												
2(c)	<table border="1"> <thead> <tr> <th>A</th> <th>B</th> <th>C</th> <th>D</th> </tr> <tr> <th>Time / min</th> <th>volume of nitrogen, V / cm^3</th> <th>V / V_{FINAL}</th> <th>$[C_6H_5N_2^+Cl^-](aq) / mol\ dm^{-3}$</th> </tr> </thead> <tbody> <tr><td>0.0</td><td>0</td><td>0.000</td><td>0.0150</td></tr> <tr><td>2.0</td><td>9</td><td>0.125</td><td>0.0131</td></tr> <tr><td>4.0</td><td>17</td><td>0.236</td><td>0.0115</td></tr> <tr><td>6.0</td><td>24</td><td>0.333</td><td>0.0100</td></tr> <tr><td>8.0</td><td>30</td><td>0.417</td><td>0.00875</td></tr> <tr><td>10.0</td><td>35</td><td>0.486</td><td>0.00771</td></tr> <tr><td>12.0</td><td>40</td><td>0.556</td><td>0.00666</td></tr> <tr><td>14.0</td><td>44</td><td>0.611</td><td>0.00584</td></tr> <tr><td>16.0</td><td>48</td><td>0.667</td><td>0.00500</td></tr> </tbody> </table>	A	B	C	D	Time / min	volume of nitrogen, V / cm^3	V / V_{FINAL}	$[C_6H_5N_2^+Cl^-](aq) / mol\ dm^{-3}$	0.0	0	0.000	0.0150	2.0	9	0.125	0.0131	4.0	17	0.236	0.0115	6.0	24	0.333	0.0100	8.0	30	0.417	0.00875	10.0	35	0.486	0.00771	12.0	40	0.556	0.00666	14.0	44	0.611	0.00584	16.0	48	0.667	0.00500	
	A	B	C	D																																										
	Time / min	volume of nitrogen, V / cm^3	V / V_{FINAL}	$[C_6H_5N_2^+Cl^-](aq) / mol\ dm^{-3}$																																										
	0.0	0	0.000	0.0150																																										
	2.0	9	0.125	0.0131																																										
	4.0	17	0.236	0.0115																																										
	6.0	24	0.333	0.0100																																										
	8.0	30	0.417	0.00875																																										
	10.0	35	0.486	0.00771																																										
	12.0	40	0.556	0.00666																																										
14.0	44	0.611	0.00584																																											
16.0	48	0.667	0.00500																																											
Column values for D correctly calculated	1																																													
3 sf in C and D	1																																													
2(d)	Candidate's calculated points correctly plotted from table in 2(c)	1																																												
	Smooth curve of best fit	1																																												
2(e)	Tangent drawn at time zero	1																																												
	2 sets of co-ordinates shown	1																																												
	calculation of gradient of tangent	1																																												
	$mol\ dm^{-3}\ minute(s)^{-1}$	1																																												
2(f)	<table border="1"> <thead> <tr> <th>concentration 1</th> <th>Time 1</th> <th>concentration 2</th> <th>time 2</th> <th>$t_{1/2}$</th> </tr> </thead> <tbody> <tr> <td>(0.0120)</td> <td>3</td> <td>(0.0060)</td> <td>13.4</td> <td>10.4</td> </tr> <tr> <td>0.010</td> <td>6</td> <td>0.005</td> <td>16.0</td> <td>10.0</td> </tr> </tbody> </table>	concentration 1	Time 1	concentration 2	time 2	$t_{1/2}$	(0.0120)	3	(0.0060)	13.4	10.4	0.010	6	0.005	16.0	10.0																														
	concentration 1	Time 1	concentration 2	time 2	$t_{1/2}$																																									
	(0.0120)	3	(0.0060)	13.4	10.4																																									
	0.010	6	0.005	16.0	10.0																																									
	Columns 1 and 3	1																																												
Columns 2 and 4	1																																													
Half-lives correctly calculated.	1																																													
2(g)	First order AND because half-lives are constant/equal	1																																												

1(a)(i)	To prevent reaction with water/hydrolysis (if wet)	1
1(a)(ii)	M1 solid / ppt NaBr forms M2 Equilibrium (position) lies (well) to the right / equilibrium position shifts to RHS	2
1(b)	M1 No naked flames AND (highly) flammable M2 Perform experiment in fume cupboard AND irritant to respiratory system / may cause dizziness / drowsiness	2
1(c)(i)	mass of NaI = $0.50 \times \frac{150}{1000} \times 149.9 = 11.2 \text{ g}$ mass of propanone = $150 \times 0.79 = 118.5 \text{ g}$	2
1(c)(ii)	M1 volume of NaI varied M2 CH ₃ CH ₂ CH ₂ Br volume (2.0 cm ³) AND total volume constant at 42.0 cm ³ AND table is complete	2
1(c)(iii)	dependent variable = time	1
1(c)(iv)	rate = 1 / time or 1 / t	1
1(c)(v)	M1 (Recording / determining) the time when opaque / cross disappears M2 dilute the solution (to give a longer time)	2
1(d)	No and because rate of S _N 1 is only dependent on (concentration) of the organic compound	1

<p>GENERIC MARKING PRINCIPLE 1:</p> <p>Marks must be awarded in line with:</p> <ul style="list-style-type: none"> <input type="checkbox"/> the specific content of the mark scheme or the generic level descriptors for the question <input type="checkbox"/> the specific skills defined in the mark scheme or in the generic level descriptors for the question <input type="checkbox"/> the standard of response required by a candidate as exemplified by the standardisation scripts.
<p>GENERIC MARKING PRINCIPLE 2:</p> <p>Marks awarded are always whole marks (not half marks, or other fractions).</p>
<p>GENERIC MARKING PRINCIPLE 3:</p> <p>Marks must be awarded positively:</p> <ul style="list-style-type: none"> <input type="checkbox"/> marks are awarded for correct/valid answers, as defined in the mark scheme. However, credit is given for valid answers which go beyond the scope of the syllabus and mark scheme, referring to your Team Leader as appropriate <input type="checkbox"/> marks are awarded when candidates clearly demonstrate what they know and can do <input type="checkbox"/> marks are not deducted for errors <input type="checkbox"/> marks are not deducted for omissions <input type="checkbox"/> answers should only be judged on the quality of spelling, punctuation and grammar when these features are specifically assessed by the question as indicated by the mark scheme. The meaning, however, should be unambiguous.
<p>GENERIC MARKING PRINCIPLE 4:</p> <p>Rules must be applied consistently e.g. in situations where candidates have not followed instructions or in the application of generic level descriptors.</p>
<p>GENERIC MARKING PRINCIPLE 5:</p> <p>Marks should be awarded using the full range of marks defined in the mark scheme for the question (however, the use of the full mark range may be limited according to the quality of the candidate responses seen).</p>
<p>GENERIC MARKING PRINCIPLE 6:</p> <p>Marks awarded are based solely on the requirements as defined in the mark scheme. Marks should not be awarded with grade thresholds or grade descriptors in mind.</p>

1(a)(i)	M1 moles needed $0.100 \square 250 / 1000 = 0.025(0)$ mol M2 $M1 \square 166.0 = 4.15$ g	2																																			
1(a)(ii)	(Re)weigh the empty weighing boat (and the difference should be 4.15 g)	1																																			
1(a)(iii)	M1 (pour using a funnel and) rinse the beaker with (distilled) water M2 add (distilled) water dropwise near the mark	2																																			
1(b)	the solution in the burette is at the expected concentration	1																																			
1(c)	12.50 (cm ³)	1																																			
1(d)(i)	step 4	1																																			
1(d)(ii)	the recorded times are repeatable / the recorded times can be duplicated / the repeated times are close to one another	1																																			
1(d)(iii)	0.5(00)%	1																																			
1(d)(iv)	acid is in excess	1																																			
1(d)(v)	M1 independent: (relative) concentration of KI / (relative) concentration of I ⁻ M2 dependent: time (taken)	2																																			
1(e)(i)	<table border="1" data-bbox="486 705 1141 1025"> <thead> <tr> <th>v / cm³</th> <th>log v</th> <th>t_{9v} / s</th> <th>(1 / t_{9v}) / s⁻¹</th> <th>log(1 / t_{9v})</th> </tr> </thead> <tbody> <tr> <td>5.00</td> <td>0.699</td> <td>219</td> <td>0.00457</td> <td>-2.34</td> </tr> <tr> <td>10.00</td> <td>1.00</td> <td>113</td> <td>0.00885</td> <td>-2.05</td> </tr> <tr> <td>12.50</td> <td>1.10</td> <td>100</td> <td>0.0100</td> <td>-2.00</td> </tr> <tr> <td>15.00</td> <td>1.18</td> <td>76.5</td> <td>0.0131</td> <td>-1.88</td> </tr> <tr> <td>20.00</td> <td>1.30</td> <td>59.0</td> <td>0.0169</td> <td>-1.77</td> </tr> <tr> <td>25.00</td> <td>1.40</td> <td>48.0</td> <td>0.0208</td> <td>-1.68</td> </tr> </tbody> </table> <p>M1 column 3 and column 6 mathematically correct M2 column 3 and column 6 to 3 sf</p>	v / cm ³	log v	t _{9v} / s	(1 / t _{9v}) / s ⁻¹	log(1 / t _{9v})	5.00	0.699	219	0.00457	-2.34	10.00	1.00	113	0.00885	-2.05	12.50	1.10	100	0.0100	-2.00	15.00	1.18	76.5	0.0131	-1.88	20.00	1.30	59.0	0.0169	-1.77	25.00	1.40	48.0	0.0208	-1.68	2
v / cm ³	log v	t _{9v} / s	(1 / t _{9v}) / s ⁻¹	log(1 / t _{9v})																																	
5.00	0.699	219	0.00457	-2.34																																	
10.00	1.00	113	0.00885	-2.05																																	
12.50	1.10	100	0.0100	-2.00																																	
15.00	1.18	76.5	0.0131	-1.88																																	
20.00	1.30	59.0	0.0169	-1.77																																	
25.00	1.40	48.0	0.0208	-1.68																																	
1(e)(ii)	M1 points plotted M2 line of best fit	2																																			
1(e)(iii)	M1 correct co-ordinates M2 correct gradient (to 3 sf) M3 first order	3																																			

2(a)	<p>M1 Addition of solid and acid must not lead to initial escape of gas from sealed system or produce excess volume measurement leading to a false volume reading e.g. Adding acid to solid already in the flask or vice versa.</p> <p>M2 Allow any leakproof apparatus capable of delivering a sample of gas into one collection vessel over water.</p> <p>M3 A vertical inverted measuring cylinder or burette filled with water positioned to collect the gas (via delivery tube).</p>	3													
2(b)(i)	<table border="1"> <tr> <td>$V_{\text{final}} - V_t / \text{cm}^3$</td> </tr> <tr> <td>93</td> </tr> <tr> <td>71</td> </tr> <tr> <td>56</td> </tr> <tr> <td>43</td> </tr> <tr> <td>32</td> </tr> <tr> <td>25</td> </tr> <tr> <td>18</td> </tr> <tr> <td>15</td> </tr> <tr> <td>14</td> </tr> <tr> <td>6</td> </tr> <tr> <td>3</td> </tr> <tr> <td>0</td> </tr> </table> <p>93, 71, 56, 43, 32, 25, 18, 15, 14, 6, 3, 0</p>	$V_{\text{final}} - V_t / \text{cm}^3$	93	71	56	43	32	25	18	15	14	6	3	0	1
$V_{\text{final}} - V_t / \text{cm}^3$															
93															
71															
56															
43															
32															
25															
18															
15															
14															
6															
3															
0															
2(b)(ii)	<p>M1 Selects and labels appropriate linear scales for axes AND All points plotted correctly AND covering at least half of the grid for each axis.</p> <p>M2 Smooth curve of best fit line drawn going through most points.</p>	2													
2(b)(iii)	The point at 240 s.	1													
2(b)(iv)	The volume of gas may have been read before 240 .	1													
2(b)(v)	<p>M1 Suitable construction lines shown on the graph.</p> <p>M2: Two half-lives read correctly from graph</p> <p>AND</p> <p>mean half-life calculated using values read correctly from graph. (Likely to be approx. 78 s)</p>	2													
2(b)(vi)	$= \frac{0.693}{\text{average } t_{1/2} \text{ calculated in 2(b)(v)}}$	1													
2(c)	<p>The value of k would increase</p> <p>AND</p> <p>as $t_{1/2}$ would decrease.</p>	1													
2(d)(i)	<p>M1 Table complete with four different sets of values that would produce different concentrations, total volume = 50 cm³</p> <p>AND</p> <p>All volumes of 2.0 mol dm⁻³ acid must be 10 cm³ or greater (to ensure an excess).</p> <p>M2 All concentrations correctly calculated.</p>	2													
2(d)(ii)	time (taken for fizzing to stop)	1													
2(d)(iii)	The experiment should be repeated to identify / eliminate anomalies.	1													

N.B. Boxes references within the mark scheme relate to the accompanying booklet of Standing Instructions.

1 Check and correct, if necessary, all subtractions in Tables 1.1 and 1.2.

(b) Accuracy Marks

Calculate the average of the Supervisor's titres in Table 1.1. This value will be used as the standard for the second set of accuracy marks and should be recorded on the Supervisor's script and against Table 1.1 on each candidate script.

Candidate consistency

Calculate the difference between the two closest titres in Table 1.1.

Award consistency marks as follows:

Mark	Difference/cm ³
3	Up to 0.10
2	0.10+ to 0.20
1	0.20+ to 0.50
0	Greater than 0.50

[3]

Comparison to Supervisor

Calculate the difference between the 'Supervisor Standard' and the closest of the Candidate values.

Award accuracy marks as follows:

Mark	Difference/cm ³
3	Up to 0.10
2	0.10+ to 0.20
1	0.20+ to 0.50
0	Greater than 0.50

[3]

- (c) Give **one mark** if all final burette readings in Tables 1.1 and 1.2 are to 2 decimal places and in the correct place in the table. Do **not** give this mark if any burette reading (initial or final) is 'absurd' e.g. 9.67 cm³. [1]

Accuracy marks

Calculate the difference between the two closest titres in Table 1.2.

Award consistency marks as follows:

Mark	Difference/cm ³
2	Up to 0.20
1	0.20+ to 0.50
0	Greater than 0.50

[2]

(d) Give one mark for $\frac{50}{1000} \times 0.20$ [1]

(e) Give one mark for $\frac{\text{titre}}{1000} \times 0.1 \times 5$ for each flask [1]

(f) Give one mark for (answer (d) - answer (e)) for each flask [1]

(g) Give one mark for answer to (e) $\times \frac{1000}{50}$ for each flask [1]

(h) Give one mark for answer to (f) $\times \frac{1000}{20}$ for Flask A
and

Give one mark for answer to (f) $\times \frac{1000}{40}$ for Flask B [2]

(i) Give one mark for evaluating $K_c = \frac{[\text{C}_2\text{H}_5\text{COOH}(\text{organic layer})]}{[\text{C}_2\text{H}_5\text{COOH}(\text{aqueous layer})]}$

and

$$K_c = \frac{\sqrt{[\text{C}_2\text{H}_5\text{COOH}(\text{organic layer})]}}{[\text{C}_2\text{H}_5\text{COOH}(\text{aqueous layer})]}$$

Give one mark for an appropriate conclusion, from results, as to correct equilibrium expression. [2]

(j) Give one mark each for suitable reasons as to why the equilibrium expression is not constant
e.g. Not shaken for sufficient time to reach equilibrium.
Variation in temperature between the two flasks. [2]

(k) Give one mark for transfer of acid from the organic layer/to the aqueous layer. [1]

[Total for Question 1: 20 marks]

N.B. Boxed references within this marking scheme relate to the accompanying booklet of Standing Instructions

1 (a) Experiment 1

Titration table Standing Instructions (f)

Check the Candidate's subtraction of each titration unless labelled Rough. The subtraction of a Rough titration should be checked if the Candidate has ticked the value and used it in calculating the average titre.

Give **one mark** if all burette readings are in the correct spaces in the table, the volume has been filled in, and all final burette readings are to at least 2 d.p. Ignore any titre which has been labelled **Rough**.

Give **one mark** for a sufficient number of titrations (any two titres differing by 0.10 cm³ or less). Award this mark on uncorrected titres – **Rough** values may be included in assessing sufficient number of titrations.

Give **one mark** for a value of volume used from the burette and **quoted in the Summary**, which is clearly justified by the Candidate's indication of the results used. **Do not give this mark if no value is quoted in the Summary, no values are ticked in the titration table or no calculation of the average is shown.** This will usually be the value of two identical titres or any other average provided it is correct to at least 2 d.p. or to the nearest 0.05 cm³ (first and second d.p.s may be omitted here if they are 0)

3

Accuracy

See section (g).

As soon as the candidate's average titre has been checked or corrected, the titre value transferred to page 4 should be confirmed and corrected as necessary.

Assign accuracy marks by comparing the candidate's average titre (corrected as necessary) with the Supervisor's value.

The Supervisor's Titre, corrected if necessary, should be recorded on the front of the script.

Apply spread penalty as shown below

Accuracy marks	
Mark	Difference from Supervisor / cm ³
5	up to 0.20
4	0.20+ to 0.25
3	0.25+ to 0.30
2	0.30+ to 0.50
1	0.50+ to 1.00
0	Greater than 1.00

Spread Penalty	
Range used / cm ³	Deduction
0.20+ to 0.25	1
0.25+ to 0.30	2
0.30+ to 0.35	3
0.35+ to 0.40	4
greater than 0.40	5

5

Suspect Supervisor Values

Adopt procedure (ii) in (h) for any suspect Supervisor results

If there is not an obvious value from the Candidates' results, use 24.20 as the Standard Value. Report your action to Team Leader on the Centre Accuracy Return.



Calculations

In all calculations, ignore evaluation errors if working is shown

(b) Give one mark for $\frac{\text{titre}}{1000} \times 0.02$ 1

(c) Give two marks for $\text{ans (a)} \times 5 \times \frac{1000}{25}$ 2
(one) (one)



(a) **Titration Tables 1.1 and 1.2**

Give one mark if

all final burette readings in both tables are to 2 decimal places, in the correct places in both tables and the subtraction in Table 1.1 is correct. titrations in Table 1.2 that are labelled Rough do **not** need to be to 2 d.p. and subtraction need not be checked **unless** the value has been included in calculating the average.

Titration Table 1.1

Give one mark if

A candidate recorded volume between 45.00 cm³ and 45.50 cm³ has been diluted.

Titration Table 1.2

Give one mark if

Two (uncorrected) titres are within 0.10 cm³

Give one mark if

a suitable average has been selected. (Do not give this mark if there is an error in subtraction in Table 1.2)

4

Accuracy

From the Supervisor's results calculate, to 2 decimal places,

$$\frac{\text{Volume of FB 1 diluted}}{45.00} \times \text{Titre}$$

Record this value as a ringed total below Table 1.2.

Calculate the same ratio for each candidate and compare with the Supervisor's value.

Award accuracy marks as shown in the table below.

The spread penalty may have to be applied using the table below.

Accuracy Marks	
Mark	Difference from Supervisor
8	Up to 0.10
7	0.10+ to 0.15
6	0.15+ to 0.20
5	0.20+ to 0.30
4	0.30+ to 0.40
3	0.40+ to 0.60
2	0.60+ to 0.80
1	0.80+ to 1.00
0	Greater than 1.00

Spread Penalty	
Range used/cm ³	Deduction
0.20+ to 0.25	1
0.25+ to 0.30	2
0.30+ to 0.35	3
0.35+ to 0.40	4
0.40+ to 0.50	5
0.50+ to 0.60	6
0.60+ to 0.80	7
Greater than 0.80	8

8

In all calculations, ignore evaluation errors if working is shown

(c) Give one mark for

$$\frac{100.0}{248.2}$$

or 0.403 or 0.4029

1

Do not give this mark if 32 is seen to be used instead of 32.1 for A_r of sulphur
0.403 without working gains this mark

(d) Give one mark for $\text{Answer to (c)} \times \frac{\text{volume of FB 1 diluted}}{250}$

1

(e) Give two marks for $\text{Answer to (d)} \times \frac{\text{titre (1)}}{1000} \times \frac{1}{2} (1)$

2

(f) Give one mark for $\frac{25}{1000} \times 0.023$ or 0.000575

1

(g) Give one mark for $\frac{\text{answer to (e)}}{\text{answer to (f)}}$

1

(h) Give one mark for correctly calculating the oxidation numbers of

Chromium in CrO_4^{2-}	(+)6
Iodine in I^-	-1
Iodine in I_2	0

Give one mark for using the reacting quantities in (g) to show that

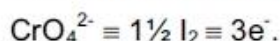

And that the oxidation number of +6 is reduced to +3.

2

Total for Question 1 20

Topic Chem 6 Titration Q# 27/ ALVI Chemistry/2018/m/TZ 2/ Paper 5/Q# 2/www.SmashingScience.org

2(a)(i)	$0.0200 \square 5 = 0.1(00) \text{ mol dm}^{-3}$	1
2(a)(ii)	M1 = 277.9 (seen anywhere) M2 = M1 $\square 0.1(00) \square 250 / 1000 = 6.9475$ M3 = M2 $\square 100 / 8 = 86.84 \text{ g}$	3
2(a)(iii)	M1 = total moles of H^+ = $(0.100 \square 8 / 5 \square 250 / 1000) = 0.04(00) \text{ mol}$ M2 = volume of 2 mol dm^{-3} sulfuric acid = $(M1 / 2) \square (1000 / 2) = 10 \text{ cm}^3$	2
2(b)	M1 Dissolve the iron(II) sulfate crystals (in the beaker) using (distilled) water M2 Filter M3 Rinse the residue If no M2 (filtration), M3 can be applied to mixture in M1 as part of transfer in M5. M4 Add H_2SO_4 M5 Transfer / add to a 250 cm^3 volumetric flask and make up to mark with (distilled) water	5
2(c)	Colourless to pink / pale purple	1
2(d)	M1 Higher M2 Some of the MnO_4^- (aq) would be used oxidising CT(aq) ions	2

Topic Chem 6 Titration Q# 28/ ALVI Chemistry/2020/m/TZ 2/ Paper 5/Q# 1/www.SmashingScience.org
Science-Specific Marking Principles

1	Examiners should consider the context and scientific use of any keywords when awarding marks. Although keywords may be present, marks should not be awarded if the keywords are used incorrectly.
2	The examiner should not choose between contradictory statements given in the same question part, and credit should not be awarded for any correct statement that is contradicted within the same question part. Wrong science that is irrelevant to the question should be ignored.
3	Although spellings do not have to be correct, spellings of syllabus terms must allow for clear and unambiguous separation from other syllabus terms with which they may be confused (e.g. ethane / ethene, glucagon / glycogen, refraction / reflection).
4	The error carried forward (ecf) principle should be applied, where appropriate. If an incorrect answer is subsequently used in a scientifically correct way, the candidate should be awarded these subsequent marking points. Further guidance will be included in the mark scheme where necessary and any exceptions to this general principle will be noted.

5 'List rule' guidance (see examples below)

For questions that require n responses (e.g. State two reasons ...):

- The response should be read as continuous prose, even when numbered answer spaces are provided
- Any response marked *ignore* in the mark scheme should not count towards n
- Incorrect responses should not be awarded credit but will still count towards n
- Read the entire response to check for any responses that contradict those that would otherwise be credited. Credit should not be awarded for any responses that are contradicted within the rest of the response. Where two responses contradict one another, this should be treated as a single incorrect response
- Non-contradictory responses after the first n responses may be ignored even if they include incorrect science.

6 Calculation specific guidance

Correct answers to calculations should be given full credit even if there is no working or incorrect working, unless the question states 'show your working'.

For questions in which the number of significant figures required is not stated, credit should be awarded for correct answers when rounded by the examiner to the number of significant figures given in the mark scheme. This may not apply to measured values.

For answers given in standard form, (e.g. $a \times 10^n$) in which the convention of restricting the value of the coefficient (a) to a value between 1 and 10 is not followed, credit may still be awarded if the answer can be converted to the answer given in the mark scheme.

Unless a separate mark is given for a unit, a missing or incorrect unit will normally mean that the final calculation mark is not awarded. Exceptions to this general principle will be noted in the mark scheme.

7 Guidance for chemical equations

Multiples / fractions of coefficients used in chemical equations are acceptable unless stated otherwise in the mark scheme.

State symbols given in an equation should be ignored unless asked for in the question or stated otherwise in the mark scheme.

1(a)	<p>M1 Order of weighing</p> <ul style="list-style-type: none"> • boat + brass is weighed • (brass transferred) • empty boat reweighed <p>M2 table + units</p> <table border="1"> <thead> <tr> <th></th> <th>/g</th> </tr> </thead> <tbody> <tr> <td>Mass of boat + brass before transfer</td> <td></td> </tr> <tr> <td>Mass of boat after transfer</td> <td></td> </tr> <tr> <td>Mass of brass transferred</td> <td></td> </tr> </tbody> </table>		/g	Mass of boat + brass before transfer		Mass of boat after transfer		Mass of brass transferred		2
	/g									
Mass of boat + brass before transfer										
Mass of boat after transfer										
Mass of brass transferred										
1(b)	toxic / poisonous gas given off	1								
1(c)	<p>M1 transfer of solution A into a 250 cm³ volumetric flask and rinsing of beaker</p> <p>M2 top up to mark of (250 cm³) volumetric flask using distilled water</p>	2								
1(d)	(25 cm ³) pipette	1								
1(e)	no more effervescence is seen	1								
1(f)	<p>M1 rinse burette with Na₂S₂O₃</p> <p>M2 (idea of) run some Na₂S₂O₃ through the tap / remove air from below tap</p>	2								
1(g)(i)	<p>M1 all titres recorded to 2 dp: 20.50; 19.65; 19.90; 19.75</p> <p>M2 (titres 1 and 3 averaged and) answer given as 19.7(0)</p>	2								

1(g)(ii)	$\left[\frac{(0.05 \times 2)}{19.90} \right] \times 100 = 0.503\%$ working must be shown	1
1(g)(iii)	increase mass of brass OR decrease concentration of $\text{Na}_2\text{S}_2\text{O}_3(\text{aq})$	1
1(h)(i)	M1 mol of thio used = $\frac{0.1 \times 16.50}{1000} = 1.65 \times 10^{-3}$ mol M2 mol of I_2 produced = $\frac{1.65 \times 10^{-3}}{2} = 8.25 \times 10^{-4}$ mol	2
1(h)(ii)	M1 mol of Cu^{2+} produced from brass in 25.00 cm^3 = $8.25 \times 10^{-4} \times 2 = 1.65 \times 10^{-3}$ mol M2 mass of Cu in brass in 250.0 cm^3 = $1.65 \times 10^{-3} \times \frac{250}{25} \times 63.5 = 1.04(775)$ g M3 percentage of Cu in brass = $\left[\frac{1.04(775)}{1.88} \right] \times 100 = 55.7\%$ OR M1 $8.25 \times 10^{-4} \times 2 = 1.65 \times 10^{-3}$ mol M2 M1 $\times \frac{250}{25} \times 63.5$ OR $1.65 \times 10^{-3} \times 63.5 = 1.04(395)$ g M3 $\left(\frac{\text{M2}}{1.88} \right) \times 100$ or $\left[\frac{1.04(395)}{1.88} \right] \times 100 = 59.8\%$	3
1(i)	(Ag^+) react with I^- / iodide (ions) to form a precipitate / solid	1

Topic Chem 6 Titration Q# 29/ ALvl Chemistry/2020/w/TZ 1/ Paper 5/Q# 1/www.SmashingScience.org

Examples of how to apply the list rule State three reasons.... [3]			
A	1. Correct	✓	2
	2. Correct	✓	
	3. Wrong	✗	
B (4 responses)	1. Correct, Correct	✓, ✓	3
	2. Correct	✓	
	3. Wrong	ignore	
C (4 responses)	1. Correct	✓	2
	2. Correct, Wrong	✓, ✗	
	3. Correct	ignore	
D (4 responses)	1. Correct	✓	2
	2. Correct, CON (of 2.)	✗, (discount 2)	
	3. Correct	✓	
E (4 responses)	1. Correct	✓	3
	2. Correct	✓	
	3. Correct, Wrong	✓	
F (4 responses)	1. Correct	✓	2
	2. Correct	✓	
	3. Correct CON (of 3.)	✗ (discount 3)	
G (5 responses)	1. Correct	✓	3
	2. Correct	✓	
	3. Correct Correct CON (of 4.)	✓ ignore ignore	
H (4 responses)	1. Correct	✓	2
	2. Correct	✗	
	3. CON (of 2.) Correct	(discount 2) ✓	
I (4 responses)	1. Correct	✓	2
	2. Correct	✗	
	3. Correct CON (of 2.)	✓ (discount 2)	

1(a)(i)	$= 0.200 \times 250 / 1000 \times 170.0 = 8.5 \text{ g}$	1
1(a)(ii)	M1: dissolve a known mass / mass in (a)(i)) / solid in (distilled water), less than 250 cm ³ (if stated), (in a suitable container) M2: transfer / add the solution to a 250 cm ³ volumetric / graduated flask (with washings) AND make up to the mark with (distilled) water.	2
1(b)	M1: number of moles $\text{C}_2\text{O}_4^{2-}(\text{aq}) = 25 / 1000 \times 0.200 = 0.005 \text{ moles}$ M2: number of moles $\text{MnO}_4^{-}(\text{aq}) = \text{answer to (b)(i)} \times 2 / 5 = 0.002 \text{ moles}$ M3: concentration = $0.002 \text{ moles} \times 1000 / 18.4 = 0.109 \text{ mol dm}^{-3}$	3
1(c)(i)	titres 2 and 4 AND they are concordant / within 0.1 cm ³	1
1(c)(ii)	$(2 \times 0.05) / 44.30 \times 100 = 0.226\%$	1
1(c)(iii)	M1: moles Fe^{2+} in 250 cm ³ = $(0.02 \text{ x} / 1000) \times 5 \times 10$ or $\text{x} (1 \times 10^{-3})$ M2: percentage is 5.58 x / y calculated correctly	2
1(c)(iv)	fewer moles of Fe^{2+} present in the solution (as some would have oxidised to Fe^{3+} which would not react with the KMnO_4)	1
1(c)(v)	to provide H^+ ions / protons for the titration OR To prevent (hydrolysis of) Fe^{2+} producing a precipitate	1
1(d)	measuring cylinder, as the acid is in excess / accuracy of the measurement is not important	1

Topic Chem 6 **Titration Q# 30**/ ALVl Chemistry/2021/m/TZ 2/ Paper 5/Q# 2/www.SmashingScience.org

2(a)	M1: (250 cm ³) volumetric flask M2: dissolve the solid / acid salt (1.89 g) (in the beaker) (using distilled) water M3: transfer / add to a (250 cm ³ volumetric) flask AND rinse (with distilled water) M4: top up to mark (with distilled water)	4
2(b)(i)	to ensure that (exactly) 25.0 cm ³ of solution has been delivered into the flask	1
2(b)(ii)	measuring cylinder	1
2(b)(iii)	difficult to see the 0.00 cm ³ line	1
2(b)(iv)	(two) titres / readings within 0.1(0) (cm ³) of each other	1
2(b)(v)	colourless to pale purple	1
2(b)(vi)	M1: mol $\text{MnO}_4^{-}(\text{aq}) = 0.0200 \times 24.40 / 1000 = 4.88 \times 10^{-4} \text{ (mol)}$ M2: mol of $\text{C}_2\text{O}_4^{2-}(\text{aq})$ (in 25.0 cm ³) = $\text{M1} \times 5 / 2 = 1.22 \times 10^{-3} \text{ (mol)}$ M3: mol of $\text{C}_2\text{O}_4^{2-}(\text{aq})$ (in solution A) = $\text{M2} \times 250 / 25 = 1.22 \times 10^{-2} \text{ (mol)}$	3
2(c)(i)	(aqueous) sodium hydroxide	1
2(c)(ii)	M1: mol $\text{H}^+(\text{aq})$ in 250 cm ³ = $6.10 \times 10^{-2} / 4 = 1.525 \times 10^{-2} \text{ (mol)}$ M2: ratio $\text{C}_2\text{O}_4^{2-}(\text{aq}) : \text{H}^+(\text{aq})$ $(1.22 \times 10^{-2} / 1.22 \times 10^{-2}) : 1.525 \times 10^{-2} / 1.22 \times 10^{-2} = 1 : 1.25$ and $b = 1.25$ M3: $2 - 1.25 a = 0.75$	3
2(c)(iii)	M1: M_r of hydrated $\text{K}_{0.75}\text{H}_{1.25}\text{C}_2\text{O}_4 \cdot n\text{H}_2\text{O} = 1.89 / 1.22 \times 10^{-2} = 154.9$ OR M_r of anhydrous $\text{K}_{0.75}\text{H}_{1.25}\text{C}_2\text{O}_4 = [(0.75 \times 39.1) + (1.25 \times 1.0) + (2 \times 12.0) + (4 \times 16.0)] = 118.575$ M2: mass of water = hydrated mass – anhydrous mass = $154.9 - 118.575 = 36.325$ AND $36.325 / 18 = 2$	2
2(d)	M1: initial readings mass of (empty) crucible / g mass of crucible + crystals before heating / g mass of crucible + crystals after heating / g M2: second reading of mass of crucible + crystals after re-heating	2

1(f)	measuring the decrease / change in (total) mass of the solution / mixture / reaction vessel (and contents) (and time) OR measuring the mass / weight of the mixture/reaction vessel (and contents) AND time	1
1(g)	M1: (filter/remove) dry the residue/metal oxide M2: weigh the residue / metal oxide to see if the mass is unchanged OR M1: re-use with new hydrogen peroxide / do the same reaction again with the same catalyst M2: and check if the gas volumes identical / rate of reaction the same	2
1(h)	to allow the oxygen / gas (that is formed) to be released / escape / diffuse out	1

Question	Answer	Marks
2(a)(i)	$M_r \text{KMnO}_4 = 158.0$ $500 \times 0.02 / 1000 = 0.01$ $0.01 \times 158.0 = 1.58 \text{ g}$	1
2(a)(ii)	$(2 \times 0.005 / 1.58) \times 100 = 0.63\%$	1
2(a)(iii)	rinse the solid off the weighing boat into the beaker OR weighing the mass directly into the beaker OR (re)-weigh the weighing boat after transferring the KMnO_4 into the beaker	1
2(a)(iv)	<i>Any two from:</i> stir / agitate / mix (to ensure that the solid has dissolved) rinse the beaker and transfer the washings shaking / inverting / homogenising of volumetric solution	2

2(b)(i)	rinse / run through / wash the burette with some of the KMnO_4 solution OR run some of the KMnO_4 solution from the burette to fill to the tip	1
2(b)(ii)	add the KMnO_4 dropwise (near the end point)	1
2(c)(i)	the $\text{Fe}^{2+}(\text{aq}) / \text{Fe}^{3+}(\text{aq})$ mixture measured using a measuring cylinder AND leads to increased likelihood of non-concordant titres	1
2(c)(ii)	(measure the volume) using a (volumetric / 25 cm^3) pipette	1

2(d)(i)	<p>Set A</p> <table border="1"> <thead> <tr> <th></th> <th>rough</th> <th>titration 1</th> <th>titration 2</th> <th>titration 3</th> </tr> </thead> <tbody> <tr> <td>final volume / cm^3</td> <td>18.40</td> <td>17.25</td> <td>34.55</td> <td>18.00</td> </tr> <tr> <td>initial volume / cm^3</td> <td>0.65</td> <td>0.15</td> <td>17.25</td> <td>0.95</td> </tr> <tr> <td>titre / cm^3</td> <td>17.75</td> <td>17.10</td> <td>17.30</td> <td>17.05</td> </tr> </tbody> </table> <p>mean titre = $17.1 \text{ (cm}^3\text{)}$</p> <p>Set B</p> <table border="1"> <thead> <tr> <th></th> <th>rough</th> <th>titration 1</th> <th>titration 2</th> </tr> </thead> <tbody> <tr> <td>final volume / cm^3</td> <td>45.05</td> <td>43.60</td> <td>43.70</td> </tr> <tr> <td>initial volume / cm^3</td> <td>0.20</td> <td>0.15</td> <td>0.10</td> </tr> <tr> <td>titre / cm^3</td> <td>44.85</td> <td>43.45</td> <td>43.60</td> </tr> </tbody> </table> <p>mean titre = $43.5 \text{ (cm}^3\text{)}$</p> <p>M1: correct titres (to 2 decimal places) M2: correct means</p>		rough	titration 1	titration 2	titration 3	final volume / cm^3	18.40	17.25	34.55	18.00	initial volume / cm^3	0.65	0.15	17.25	0.95	titre / cm^3	17.75	17.10	17.30	17.05		rough	titration 1	titration 2	final volume / cm^3	45.05	43.60	43.70	initial volume / cm^3	0.20	0.15	0.10	titre / cm^3	44.85	43.45	43.60	2
	rough	titration 1	titration 2	titration 3																																		
final volume / cm^3	18.40	17.25	34.55	18.00																																		
initial volume / cm^3	0.65	0.15	17.25	0.95																																		
titre / cm^3	17.75	17.10	17.30	17.05																																		
	rough	titration 1	titration 2																																			
final volume / cm^3	45.05	43.60	43.70																																			
initial volume / cm^3	0.20	0.15	0.10																																			
titre / cm^3	44.85	43.45	43.60																																			
2(d)(ii)	<p>M1: $n \text{MnO}_4^- (\text{aq}) = 43.5 \times 0.02 / 1000 = 8.70 \times 10^{-4}$ $n \text{Fe}^{2+} (\text{aq}) = 8.70 \times 10^{-4} \times 5 = 4.35 \times 10^{-3}$</p> <p>M2: mass of $\text{Fe}^{2+} (\text{aq}) = 4.35 \times 10^{-3} \times 55.8 \times \frac{100}{25} = 0.971 \text{ g}$</p>	2																																				

2(d)(iii)	$n \text{MnO}_4^- (\text{aq}) = 17.1 \times 0.02 / 1000 = 3.42 \times 10^{-4}$ $n \text{Fe}^{2+} (\text{aq}) = 3.42 \times 10^{-4} \times 5 = 1.71 \times 10^{-3}$ $\text{mass of Fe}^{2+} (\text{aq}) = 1.71 \times 10^{-3} \times 55.8 \times \frac{250}{25} = 0.954 \text{ g}$	1
2(d)(iv)	$\% \text{Fe}^{3+} = ((2(\text{d})(\text{ii}) \times \frac{250}{100}) - 2(\text{d})(\text{iii})) / (2(\text{d})(\text{ii}) \times \frac{250}{100}) \times 100\%$ OR $(2(\text{d})(\text{ii}) \times 2.5 - 2(\text{d})(\text{iii})) / (2(\text{d})(\text{ii}) \times 2.5) \times 100\%$	1
2(d)(v)	reduce / use (in step 6) more than 100 cm ³ of solution (Fe ²⁺ and Fe ³⁺)	1

Topic Chem 7 **Titration Q# 32**/ ALVI Chemistry/2014/w/TZ 1/ Paper 5/Q# 2/www.SmashingScience.org

2 (a)	All plotted points correctly drawn	1	[2]
	The best fit line should pass through or lie close to the first 10 points. (If all points do not lie on the line then the net deviation of the non-anomalous points on each side of the best fit line must be approximately the same.)	1	
(b)	The point at 12.00 cm ³ is an anomaly. (ECF from incorrect anomalous point.)	1	[2]
	The sodium hydroxide has not been properly mixed with the acid OR insufficient sodium hydroxide was added.	1	
(c)	Indicator range between 6.5 and 11 for a minimum of 1 pH unit change.	1	[1]
(d) (i)	Any two of the following: Na ⁺ , A ⁻ , HA	1	[1]
	(ii) They will all have (nearly) the same concentration OR A ⁻ > Na ⁺ > HA Half of the HA has reacted with/been neutralised by / used up by the NaOH	1 1	[2]
(e)	Reads correct value of pH from the graph drawn	1	[3]
	Gives correct expression for K _a	1	
	Calculates K _a	1	
(f) (i)	[H ⁺] = 0.00389 mol dm ⁻³ OR [H ⁺] = [A ⁻] ECF as (ans to [H ⁺]) ² / (ans to (e))	1	[2]
	Calculates [HA] correctly based on the pH read from the graph	1	
(ii)	Conc of HA = 4 × 2.7 = 10.8 g dm ⁻³ Relative molecular mass of HA = 10.8 / 2(f)(i)	1	[1]
(g)	Any appropriate error discussion e.g.: <ul style="list-style-type: none"> many readings / measurements are taken each of which will have an error., the H⁺ from the water has been ignored, no pH reading was taken at 15.00 cm³, H⁺ is not exactly equal to A⁻ temperature varies during titration, graph drawn by hand is not very accurate, experiment not repeated. 	1	[1]
Total			15

1 (a) (i)	M10	$\text{HCOO}^- (\text{aq}) \longrightarrow \text{CO}_2(\text{g}) + \text{H}^+(\text{aq}) + 2\text{e}^-$ $\text{MnO}_4^- (\text{aq}) + 8\text{H}^+(\text{aq}) + 5\text{e}^- \longrightarrow \text{Mn}^{2+}(\text{aq}) + 4\text{H}_2\text{O}(\text{l})$	[1] [1]
(ii)	M6	Magnesium methanoate is $1.312 \text{ mol dm}^{-3}$ $[\text{HCOO}^- (\text{aq})] = 2.624 \text{ mol dm}^{-3}$	[1] [1]
(iii)	M6	Use <u>volumetric apparatus</u> (to measure 5.0 cm^3 / saturated (magnesium) methanoate solution). Make (the above) up to the mark (with water) in a 250 cm^3 volumetric / graduated flask	[1] [1]
(iv)	M3/P4	H^+ is needed for the reaction with manganite Provided the acid is in excess / sufficient / enough, the volume does not matter	[1] [1]
(v)	M5	A <u>pale</u> pink colour	[1]
(vi)	M10	$0.051 \text{ mol dm}^{-3}$	[1]
(vii)	M10	1.28 mol dm^{-3}	[1]
(b)	P1/P2	(Independent) Temperature (Dependent) Concentration of magnesium methanoate	[1]
(c)	P3	ΔH is positive (An increase in temperature) will favour / promote / increase / a movement in the direction of the endothermic change / reaction	[1] [1]
(d)	P3	Precipitate is formed / barium sulfate is insoluble / insoluble product	[1]

SMASHING!!!

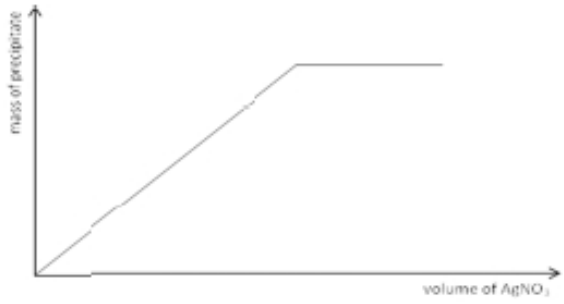

1(a)(i)	silver chromate(VI)/silver chromate $2\text{Ag}^+ + \text{CrO}_4^{2-} \rightarrow \text{Ag}_2\text{CrO}_4$ OR $2\text{Ag}^+ + \text{K}_2\text{CrO}_4 \rightarrow \text{Ag}_2\text{CrO}_4 + 2\text{K}^+$ OR $2\text{AgNO}_3 + \text{K}_2\text{CrO}_4 \rightarrow \text{Ag}_2\text{CrO}_4 + 2\text{KNO}_3$	1 1 2
1(a)(ii)	insoluble/solid barium chromate(VI)/barium chromate would form	1 1
1(a)(iii)	insoluble/solid barium sulfate is formed	1 1
1(b)	 <p>correctly labelled axes straight line through origin AND reaches a plateau</p>	1 1 2
1(c)(i)	Volumetric/graduated flask 250 cm ³ pipette (graduated) 25 cm ³ burette 50 cm ³	2
1(c)(ii)	Dissolve/stir/mix known mass/all of hydrated salt in (a container with) (distilled water) (Transfer/add to a) volumetric flask, make to mark (with distilled water) or to the volume of the stated volumetric flask (in 1(c)(i) or 1(c)(ii)) NOTE: Water must be mentioned at least once for one mark to be awarded. Distilled/deionised/purified water must be mentioned for 2 marks to be awarded.	1 1 2
1(c)(iii)	first = sulfuric acid second = potassium chromate(VI) third = silver nitrate	1 1
1(c)(iv)	experiment/titration is repeated to get concordant titre	1 1
1(c)(v)	$0.0128 \times 208.3 = 2.67 \text{ g of BaCl}_2$ AND $3.13 - 2.67 = 0.46 \text{ g of H}_2\text{O}$ $x = (0.46 / 18.0) \div 0.0128 = 2$	1 1 2
1(d)	Potassium chromate (solution) – (health hazard in context of) respiratory irritation AND fume cupboard / face / nose / mouth mask OR Potassium chromate – (health hazard in context of) skin irritation AND (chemical resistant) gloves OR barium chloride (solid) as toxic AND (chemical resistant) gloves / large dilution on disposal OR Sulfuric acid as irritant / skin irritant AND (chemical resistant) gloves	1 1
Total:		15

1	(a) (i)	(Solubility will) decrease	1
		Dissolving/reaction is exothermic so reaction shifts left (owtte). Increase negates both marks. Allow: Variations in the wording but the word exothermic or heat evolved or the reverse process must be included.	1
	(ii)	Axes are correctly labelled AND graph is a curve/straight line showing a decrease in solubility with temperature. (ignore units) Graph goes through the point 25 on temperature scale and 5 on solubility scale AND goes from 0 to 100 °C Allow ecf from (i) prediction.	1 1
	(b)	(i) temperature (increase) (ii) solubility (of chlorine)	1
(c)	1	Pipette (5, 10, 20, 25, 50 cm ³), burette (25, 50 or 100 cm ³) both required for mark.	1
	2	Starch indicator AND blue/blue-black AND colourless/opaque.	1
	3	Concentration of Cl ₂ = 0.0704 mol dm ⁻³ .	1
	4	Calculates M _r of Na ₂ S ₂ O ₃ .5H ₂ O as 248.2 AND calculates mass with unit required for a solution of stated concentration and volume. (Allow any concentration)	1
	5	Mass and volume used must produce a solution twice as concentrated as the chlorine solution (ecf from Cl ₂).	1
	6	Describes making of solution in <u>volumetric flask</u> which must include: <u>dissolving</u> , making up <u>to mark</u> .	1
	7	Titration is repeated to achieve concordant titration results/average titre, 'concordant' not required if meaning clear.	1
	8	Calculates moles Cl ₂ in titration from 0.5 × moles thiosulfate in titre and therefore concentration AND concentration of Cl ₂ in mol dm ⁻³ in aqueous chlorine. Allow any explanation which covers these points, calculations involving concentrations or moles to mass and concentration in g dm ⁻³ , or any formula that would produce a correct answer e.g. $mv / n = mv / n$	1
(d)		Chlorine OR iodine are harmful Wear a mask/use a fume cupboard/for iodine if harmful to skin/eyes given, allow resistant gloves/goggles	1 1
			[Total: 15]

GENERIC MARKING PRINCIPLE 5:

Marks should be awarded using the full range of marks defined in the mark scheme for the question (however; the use of the full mark range may be limited according to the quality of the candidate responses seen).

GENERIC MARKING PRINCIPLE 6:

Marks awarded are based solely on the requirements as defined in the mark scheme. Marks should not be awarded with grade thresholds or grade descriptors in mind.

1(a)(i)	M1: moles of Y_2O_3 = $0.750 \div (2 \times 88.9 + 3 \times 16.0)$ = $0.750 \div 225.8$ = $3.32 \times 10^{-3}(\text{mol})$ 3.3215235×10^{-3} M2: mass of $BaCO_3$ = $4 \times 3.32 \times 10^{-3} \times (137.3 + 12.0 + 3 \times 16.0)$ = $4 \times 3.32 \times 10^{-3} \times 197.3$ = 2.62 (g) 2.6213463 M3: mass of CuO = $6 \times 3.32 \times 10^{-3} \times (63.5 + 16.0)$ = $6 \times 3.32 \times 10^{-3} \times 79.5$ = 1.58 (g) 1.5813667	3
1(a)(ii)	heat solid again (and allow to cool) AND (to) constant mass	1
1(b)(i)	(Prevents) reaction of Cu^{2+} with I^- OR (prevents) formation of CuI / Cu^+ / copper(I) OR (prevents) oxidation of I^- (to I_2) by Cu^{2+}	1
1(b)(ii)	I^- is oxidised (to I_2) in acidic solution	1
1(b)(iii)	2A	1
1(c)(i)	$1.0 \times 250.0 / 1000 \times 294.0 = 73.5$ (g)	1
1(c)(ii)	M1: Dissolve / make a solution in (beaker) in (small volume of distilled water) M2: Add / transfer solution to a <u>250 cm³ volumetric flask</u> M3: Make to mark of (volumetric) flask with distilled water and the washings	3
1(d)	M1: titres are not concordant M2: repeat titration until concordant titres are obtained OR improved valid experimental technique	2

2

- (a) Give **one mark** if the apparatus drawn is suitable for the reaction of lithium with water and the collection of gas. *Do not allow delivery tubes etc to pass through apparatus.*
In assessing apparatus consider "Could it be set up with real apparatus?"
"Would it work?"

Give **one further mark** if the apparatus drawn or named in the diagram is suitable for measuring the volume of gas collected.

An unnamed gas syringe or inverted measuring cylinder must show graduations in the diagram to score this mark.

No graduations need be drawn if the apparatus has been correctly labelled.

[2]

- (b) Give **one mark** for an answer that involves one of the following:
- (i) the removal of the oil before weighing (wiping or dissolving in suitable non-aqueous solvent)
 - (ii) removing the oxidised outer layer
 - (iii) cutting the lithium to expose fresh metal to the water

[1]

- (c) Give **one mark** for a suitable safety measure **and** reason:
- (i) use of tweezers or similar/gloves to handle lithium as reactive with moisture on skin
 - (ii) keeping a flame away from the apparatus as hydrogen is flammable
 - (iii) wearing gloves as lithium hydroxide is corrosive / highly alkaline

In parts (b) and (c) ignore non-scoring suggestions

[1]

- (d) Give **one mark** for $\frac{100}{24000}$ mole of hydrogen (4.17×10^{-3})

Give **one mark** for (mole of hydrogen) $\times 2$ (8.34×10^{-3})

Give **one mark** for $\frac{0.0583}{8.34 \times 10^{-3}} = 6.99599\dots\dots\dots$

The value evaluated depends on rounding and the stage at which rounding took place.

6.94, 6.99, 6.996, 7.0, 7.02 or 7 are likely to be seen.

[3]



Some candidates may attempt the calculation using $pV = nRT$

$$\text{or } pV = \frac{m}{M_r} nRT$$

Give one mark for $\text{Moles of Li} = \frac{0.0583}{A_r}$

Give one mark for $\text{Moles of H}_2 = \frac{0.0583}{2A_r}$

Give one mark for equating to 100 cm³ of gas and evaluating the answer:

$$\frac{0.0583}{2A_r} = \frac{100}{24000}$$

Other methods of performing the calculation may be seen and should be fitted into the pattern of the methods above.

Examiners should be confident that the use of the mole ratio, (2Li \equiv 1H₂), has been applied by the candidate both correctly and confidently.

Guard against the sudden appearance of an unjustified 2 in a muddled calculation.

- (e) Give one mark for variable conditions (temperature or pressure) / 24 dm³ is approximate V_m

AND

Give one further mark for a 'chemical' or 'procedural' reason such as:

- (i) lithium is covered with a layer of oxide or lithium reacts with "air" / moisture in the air after or during weighing / cutting / transfer
- (ii) residual oil on the lithium
- (iii) insufficient water for all the lithium to react or excess lithium
do not give this mark for - "not all of the Li reacts"
- (iv) loss of gas at start before apparatus is sealed
do not give this mark for general loss of gas or leaking apparatus

[2]

- (f) Give one mark for stating that a titration would be used or evaporation to dryness of LiOH or a salt prepared from LiOH + weighing the solid remaining after evaporation

[1]

- (g) Give one mark for reference to one of
- (i) standard or standard / standardised acid used in the titration
 - (ii) obtaining concordant titres
 - (iii) % error in pipette and burette is very small (or equivalent)
 - (iv) the end-point of a titration is sharp / precise (or equivalent)
 - (v) balances weigh to 3 decimal places (or better)

The answer to (g) must be related to the answer in (f).

[1]

Total for Question 2 = [11]
Total for Paper = [30]

(a) Give one mark if errors of the appropriate size are indicated for the thermometer used.

-10 °C to 110 °C by 1 degree	Error (±) 0.5 °C
0 °C to 50 °C by 0.5 degree	Error (±) 0.25 °C
0 °C to 50 °C by 0.2 degree	Error (±) 0.1 °C

Units are not required.

The answer given must relate to the graduations given on page 4. [1]

(b) Give one mark for an answer that indicates the acid is in excess (precise measurement of volume not necessary). [1]

(c) Give one mark for need to saturate the acid with carbon dioxide before carrying out the experiment or similar argument.

Give one mark for answers such as:

to ensure that all the CO₂ produced is collected/measured, or
so that all the CO₂ liberated will be from the X₂CO₃, or
so that no more CO₂ dissolves (in the acid) during the experiment or
explaining that a reduction in the mass of carbon dioxide evolved or volume of carbon dioxide collected will lead to a higher inaccurate value of M_r or A_r. [2]

(d) For each major error identified:

Give one mark for stating the nature of the error (E mark).

This mark is given for identifying any deficiency/variable that will have an influence on the calculated value of M_r.

e.g. Solubility of CO₂ in water/temperature changes alter the volume of gas collected.

Give one mark for indicating a suitable method of eliminating the error (M mark).

This mark is for a practical way of rectifying the deficiency/keeping the variable constant.

e.g. Collect the gas in a gas syringe/use of a water bath to control temperature.

Give one mark for explaining how the error will be eliminated/reduced by the method selected (P mark).

This mark must be for an explanation based on the method selected.

e.g. No water involved in collection to dissolve the gas/knowing the temperature pV=nRT can be used in calculating moles of gas.

Some candidates may miss the idea of saturating the HCl with CO₂ in test (c) but give an error in (c) that would score one or more marks from section (d).

These marks may be awarded unless the same error has been repeated on page 10.

If the idea of saturating the acid with CO₂ is given on p10 rather than on p8 the marks can be awarded retrospectively.

The three marks in each section may be found at any point in a candidate's answer.

The error will often be found within the explanation.

Annotate each mark as shown in the table which lists some possible answers.

Other acceptable answers that meet the criteria above may be seen.

	Error ✓E	Method ✓M	Explanation ✓P
1	Loss of gas at start of experiment	Carbonate placed inside flask before mixing <i>If dropping funnel used...</i>	Sealed system Needs to compensate for acid added
2	Poor measurement of volume using measuring cylinder	Replace cylinder with burette or gas syringe	Greater accuracy of scales
3	Solubility of CO ₂ in (collecting) water	Use gas syringe to collect the gas	No water in collecting apparatus
		Raise temperature of the water in the trough	Solubility of CO ₂ decreases at higher temperatures
		Use an alternative solvent	CO ₂ insoluble in the solvent
		<i>Saturate (collecting) water with CO₂</i>	<i>All of gas collected as no more can dissolve</i>
4	Gas collected in measuring cylinder is not at atmospheric pressure	Equalise water levels inside and outside of measuring cylinder	Read volume at atmospheric pressure
5	<i>Gas collected contains water vapour</i>	<i>Dry gas (but must not then be collected over water)</i>	Suitable drying agent suggested <i>(even if dried and collected over water)</i>
		<i>Use gas syringe to collect the gas</i>	<i>No water in collecting apparatus</i>
6	<i>water contained in gas or vapour pressure of water varies with temperature</i>	Lower temperature	
		Control temperature - <i>appropriate method described</i>	Make adjustment for svp to pressure of gas for controlled temperature
7	Gas collected contains water vapour which contributes to the gas pressure	Correct for pressure for svp or Use a solvent with low vapour pressure	(Temperature and) pressure readings necessary and correction from table
8	Volume of gas varies with changes in pressure	Need to measure temperature of water bath and atmospheric pressure	Moles of gas calculated using $pV=nRT$
9	Volume of gas varies with changes in temperature or Temperature not known/measured	Use a constant temperature water bath	Apply $pV=nRT$
10	Solid is damp or Reference to 0.35% water from the assay	Dehydrate/heat the solid	Lower volume of CO ₂ or too great a mass if not dried
11	CO ₂ is a non-ideal gas	Use modified gas equation	
12	Solubility of carbon dioxide in water varies with temperature	Maintain a constant temperature - <i>appropriate method described</i>	Use data to obtain to correct for dissolved carbon dioxide at the constant temperature
13	Reference to the solid only being 99% pure. <u>The purity must be quoted from the assay</u>		Explaining: that carbonate impurities would increase carbon dioxide or unreactive components reduce carbon dioxide

2 x [3]

[Total: 10]

[Total for Paper: 30]

2 (a)	ACE Data	<p>The required two column headings temperature, (A + 273), /K and volume, (B + 26), /cm³ are fully correct. The full word for the unit can be used with or without / or ().</p> <p>Both columns are fully completed to the correct number of significant figures. Allow 2 errors.</p>	<p>[1]</p> <p>[1]</p>
(b)	ACE Data	<p>Label the x-axis temperature and the y-axis volume. Any correct unambiguous label is acceptable e.g. column label (A). Units must be present in the accepted forms. The plotted points must cover at least half the grid in both directions and all points must be on the given grid. If a true origin has been scaled in and the candidate's line is extrapolated back to there then the origin is to be included as a "plotted point" in the assessment of covering half the grid in both directions. This mark not available for other plots.</p> <p>Check the plotting of points 1, 3, 8, 10 and any obvious error.</p> <p>Give one mark for drawing a 'straight-line of best fit' (allow 'ecf' here from incorrectly plotted points).</p>	<p>[1]</p> <p>[1]*</p> <p>[1]*</p>
(c)	ACE Evaluation	<p>Incorrect plots of (i) volume/temp °C and (ii) volume change/temp will still allow these marks to be accessed. Any other wrong plots will not.</p> <p>Allow the candidate to select up to five anomalies which must include that furthest from the line.</p> <p>All the anomalous points are circled on the grid or unambiguously stated in the text.</p> <p>For each of the two different anomalies an appropriate explanation gains one mark.</p> <p>Point 3 (V low). Gas not equilibrated with the <u>increased</u> temperature, OR volume read before all the gas attained the <u>increased</u> temperature. OR volume read before 5 minutes at the <u>increased</u> temperature.</p> <p>Point 8 (V high). Gas not equilibrated with the <u>decreased</u> temperature, OR volume read before all the gas attained the <u>decreased</u> temperature. OR volume read before 5 minutes at the <u>decreased</u> temperature.</p> <p>If the candidate suggests that the gas is not equilibrated for both anomalous points but does not specify the direction of temperature change to that point, award 1 mark.</p>	<p>[1]</p> <p>[2]</p>

(d)	ACE data	(i) For, two pairs of construction lines on the graph drawn from the line to the axes and for correctly deducing the graph values of these two intercepts, give one mark. There has to be some indication on the graph of the intercepts used to calculate the gradient. These could be table points, provided they are indicated on the graph. If the true origin has been used in calculating the slope then only one pair of lines and one intercept is necessary.	[1]*
		A correctly calculated value of the slope using the candidate's figures. The mark is for the magnitude (ignore units). If the candidate used the true origin in the slope calculation then two zeros are not needed in the calculation.	[1]*
		If the slope expression is inverted, then the calculation mark is lost but the intercept value mark can be gained.	
		(ii) For a correctly read intercept at 273K give one mark. This mark is available for other permitted wrong plots as in 2(c), but for a volume change/temp plot 26 cm^3 has to be added to the read intercept. Allow a calculated volume only if the candidates line on the graph was extrapolated to the true origin. Units must be included.	[1]
(e)	ACE Evaluation	The data is reliable as most (6 or more) of the points/results/data lie on the line of best fit. Accept few anomalous points.	[1]
		If there are 6 or more points not on the line then accept that the results are not reliable.	
(f)	ACE Conclusion	These marks not available for other plots.	
		For a statement that the 'law' is justified because a straight line (direct proportionality) is obtained give one mark.	[1]
		The data confirms the relationship $V = kT$ or that volume is directly proportional to absolute temperature. Calculations showing that V/T is the same for more than 1 point on the graph are worth 1 mark.	[1]
(g)	ACE Conclusion	A second line on the grid above the original line. This second line to have a greater slope (not parallel) and not touching the original line unless at the true origin (if used). Again, this mark is available for the other permitted plots as in 2(c).	[1]
		(* is mark available for other plots)	
			[Total: 15]

1 (a)	$PV = nRT$ $M_r = \text{mass/amount in mol}$ OR $M_r = m/n$ OR g/n OR any of these formulae correctly re-arranged	[1] [1]
(b) (i)	volume (measured/ recorded at 60 °C) is higher OR volume is lower at 50 °C/ at lower temperature (calculated) M_r is lower	[3]
(ii)	The volume would be reduced OR as P increases M_r increases AND answer closer to the true value/yes	[1]
(c)	Place water/ oil/ sand within the outer VM tube AND heat the outer tube Shows appropriate connections to collect the air over water/ in syringe (any size) using the side tube	[1] [1]
(d)	Hexane: <ul style="list-style-type: none"> • is (in)flammable / burns readily • causes irritation to the skin • causes breathing difficulties • forms explosive mixture (with air) OR is combustible Any one from the list above	[1]
(e) (i)	The air expands (And) goes into the collection apparatus	[1] [1]
(ii)	(Wait until) no more bubbles (of air are produced) in the water/ syringe no longer moves	[1]
(f)	The mass of tube + hexane and mass of empty tube Temperature and pressure Syringe reading before hexane is added + the syringe reading after hexane is added	[1] [1] [1]
Qn1		[Total: 15]

(b)	P1/P2	(Independent) Temperature (Dependent) Concentration of magnesium methanoate	[1]																																				
(c)	P3	ΔH is positive (An increase in temperature) will favour / promote / increase / a movement in the direction of the endothermic change / reaction	[1] [1]																																				
(d)	P3	Precipitate is formed / barium sulfate is insoluble / insoluble product	[1]																																				
			[15]																																				
2 (a) (i)	D1	$K_c = \frac{[HI]^2}{[H_2][I_2]}$	[1]																																				
(ii)	D1	$K_c = \frac{4y^2}{(a - y)^2}$	[1]																																				
(b) (i)	D3	<table border="1"> <thead> <tr> <th>a mol dm⁻³</th> <th>a - y mol dm⁻³</th> <th>y mol dm⁻³</th> </tr> </thead> <tbody> <tr><td>0.200</td><td>0.022</td><td>0.178</td></tr> <tr><td>0.500</td><td>0.050</td><td>0.450</td></tr> <tr><td>0.800</td><td>0.252</td><td>0.548</td></tr> <tr><td>1.000</td><td>0.200</td><td>0.800</td></tr> <tr><td>1.500</td><td>0.365</td><td>1.135</td></tr> <tr><td>2.100</td><td>0.570</td><td>1.530</td></tr> <tr><td>2.800</td><td>0.652</td><td>2.148</td></tr> <tr><td>3.400</td><td>0.700</td><td>2.700</td></tr> <tr><td>3.800</td><td>0.867</td><td>2.933</td></tr> <tr><td>4.200</td><td>0.868</td><td>3.332</td></tr> <tr><td>4.900</td><td>1.150</td><td>3.750</td></tr> </tbody> </table> <p>All results for y are to 3 decimal places All values for y are correct</p>	a mol dm ⁻³	a - y mol dm ⁻³	y mol dm ⁻³	0.200	0.022	0.178	0.500	0.050	0.450	0.800	0.252	0.548	1.000	0.200	0.800	1.500	0.365	1.135	2.100	0.570	1.530	2.800	0.652	2.148	3.400	0.700	2.700	3.800	0.867	2.933	4.200	0.868	3.332	4.900	1.150	3.750	[1] [1]
a mol dm ⁻³	a - y mol dm ⁻³	y mol dm ⁻³																																					
0.200	0.022	0.178																																					
0.500	0.050	0.450																																					
0.800	0.252	0.548																																					
1.000	0.200	0.800																																					
1.500	0.365	1.135																																					
2.100	0.570	1.530																																					
2.800	0.652	2.148																																					
3.400	0.700	2.700																																					
3.800	0.867	2.933																																					
4.200	0.868	3.332																																					
4.900	1.150	3.750																																					
(ii)	D1	All points plotted correctly	[1]																																				
(iii)	E5	Appropriate straight line drawn through the origin	[1]																																				

(c) (i)	D3/C1	Co-ordinates read correctly from the line	[1]
		Slope of the graph calculated correctly and given to three significant figures with no units.	[1]
(ii)	D3/C1	Uses $\frac{\sqrt{K_c}}{2 + \sqrt{K_c}}$ = gradient (value or y/a) and provides working	[1]
		Gives value of K_c	[1]
(d)	P4	The hydrogen with air / oxygen is explosive at 760K / raised temperature	[1]
(e)	E4	Faster reaction / increased rate	[1]
		The value of K_c would be unaffected	[1]
(f) (i)	E4/C2	The line drawn on the graph has a less steep gradient	[1]
(ii)		The equilibrium constant will be smaller	[1]
			[15]

Topic Chem 7 **Gas volume Q# 46/** ALvl Chemistry/2020/s/TZ 1/ Paper 5/Q# 2/www.SmashingScience.org

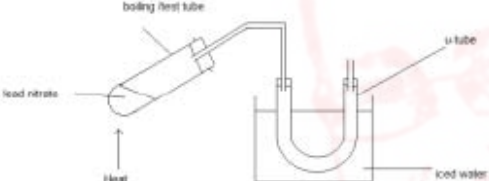
2(a)	 <p>M1 Heating a tube containing lead nitrate. Labels: Lead nitrate AND Heat A Bunsen for heat</p> <p>M2 Use of iced water for cooling an unsealed collection vessel Labels: Iced water A Cold water</p>			2																															
2(b)	kPa ⁻¹		1																																
2(c)(i)	Thermostatically controlled water bath		1																																
2(c)(ii)	<table border="1" data-bbox="247 1451 737 1832"> <thead> <tr> <th>T / K</th> <th>1 / T / K⁻¹</th> <th>K_p</th> <th>Log₁₀K_p</th> </tr> </thead> <tbody> <tr> <td>377</td> <td>0.00265</td> <td>0.076</td> <td>-1.12</td> </tr> <tr> <td>361</td> <td>0.00277</td> <td>0.122</td> <td>-0.91</td> </tr> <tr> <td>344</td> <td>0.00291</td> <td>0.257</td> <td>-0.59</td> </tr> <tr> <td>330</td> <td>0.00303</td> <td>0.741</td> <td>-0.13</td> </tr> <tr> <td>315</td> <td>0.00317</td> <td>1.506</td> <td>0.18</td> </tr> <tr> <td>312</td> <td>0.00320</td> <td>3.490</td> <td>0.54</td> </tr> <tr> <td>295</td> <td>0.00339</td> <td>9.025</td> <td>0.96</td> </tr> </tbody> </table> <p>M1 Column 2 to 3 SF</p> <p>M2 Column 4 to 2 DP</p>	T / K	1 / T / K ⁻¹	K _p	Log ₁₀ K _p	377	0.00265	0.076	-1.12	361	0.00277	0.122	-0.91	344	0.00291	0.257	-0.59	330	0.00303	0.741	-0.13	315	0.00317	1.506	0.18	312	0.00320	3.490	0.54	295	0.00339	9.025	0.96		2
T / K	1 / T / K ⁻¹	K _p	Log ₁₀ K _p																																
377	0.00265	0.076	-1.12																																
361	0.00277	0.122	-0.91																																
344	0.00291	0.257	-0.59																																
330	0.00303	0.741	-0.13																																
315	0.00317	1.506	0.18																																
312	0.00320	3.490	0.54																																
295	0.00339	9.025	0.96																																

2(c)(iii)	M1 7 points plotted correctly	1
	M2 Line of best fit drawn	1
2(d)(i)	Not accurate as there is a lot of scatter about the line of best fit	1
2(d)(ii)	Temperature of each experiment is difficult to record accurately	1
2(d)(iii)	Repeat and take an average	1
2(e)(i)	M1 Co-ordinates read and recorded correctly	1
	M2 Gradient calculated to 3 SF	1
2(e)(ii)	M1 Rearrangement to show $-\Delta H/2.303R = \text{Gradient}$	1
	M2 Gradient x 2.303 x 8.31 correctly calculated	1
2(f)(i)	M1 K_p is inversely proportional to temperature	1
	M2 Because ΔH has a negative value.	1
2(f)(ii)	M1 Darker brown	1
	M2 Equilibrium shifts to left hand side (at higher temperatures).	1

Topic Chem 9 **Gas volume Q# 47/** ALVI Chemistry/2016/s/TZ 1/ Paper 5/Q# 1/www.SmashingScience.org

1 (a)	lithium and water being labelled in an arrangement that shows them coming into contact at some time	[1]
	gas syringe OR collection over water, both using a leak-proof connection to the reaction vessel that would collect gas after the reagents have been mixed	[1]
	a valid separation of the two reagents	[1]
(b) (i)	cut (a small piece) AND remove oil	[1]
(ii)	no change/increase in volume OR bubbles (in collector) cease (over water) OR no more gas/hydrogen collected	[1]
(iii)	safety precautions – in a Li/LiOH/H ₂ context Any two from <ul style="list-style-type: none"> avoid skin contact/wear gloves/lab coat / use tongs in context of prevention of burns or corrosive contact only keep piece of lithium/storage vessel/apparatus away from water ensure unused lithium is all returned to storage vessel or stored under oil keep away from naked flames/burner/sources of ignition 	[2]
(iv)	$(0.1/7 \times 1/2 \times 24000) = 171 \text{ cm}^3$ correct unit MUST be present	[1]
(v)	use 200 cm ³ OR 250cm ³ OR 500 cm ³ - the size must be reasonable and consistent with the volume in b(iv) . correct unit MUST be present	[1]
(c) (i)	use a burette twice or 50 cm ³ pipette twice	[1]
(ii)	lithium/ solid has all reacted /disappears / dissolves	[1]
(iii)	pipette /burette /syringe /graduated pipette	[1]
(iv)	repeat the titration until results are within 0.1 cm ³	[1]
(d)	beaker : Effect: (A _r) (appears) more/larger AND Reason: (LiOH) solution more dilute (than expected)	[1]
	Flask: Effect: (A _r) None AND Reason: moles of (LiOH) (put in conical flask) remains the same /volume (i.e. moles) of LiOH not altered	[1]
		[15]

2(a)(i)	<table border="1"> <tbody> <tr><td>0.25</td></tr> <tr><td>0.37</td></tr> <tr><td>0.54</td></tr> <tr><td>0.76</td></tr> <tr><td>1.00</td></tr> <tr><td>1.30</td></tr> <tr><td>1.64</td></tr> <tr><td>1.91</td></tr> <tr><td>2.19</td></tr> </tbody> </table>	0.25	0.37	0.54	0.76	1.00	1.30	1.64	1.91	2.19	1
0.25											
0.37											
0.54											
0.76											
1.00											
1.30											
1.64											
1.91											
2.19											
2(b)(i)	M1: all ten points plotted correctly M2: straight line passing through 0,0	2									
2(b)(ii)	8th point circled 720,1.64	1									
2(b)(iii)	(volume of gas too high and) could be caused by volume being measured at a temperature higher than 298 K OR (total mass of gas lost too low and) could be caused by mass reading taken before the tap closed	1									
2(c)(i)	M1: coordinates must be in the format x,y and lie on the line of best fit M2: gradient calculated correctly with positive value	2									
2(c)(ii)	M1: Manipulation of $pV = nRT$ to include M_r in any expression, e.g. $M_r = \frac{m}{V} \times \frac{RT}{p} \text{ or } M_r = \text{gradient} \times \frac{RT}{p}$ OR partial / full substitution of data for symbols M2: Correct use of units and $pV = nRT$ to a numerical answer to 1 dp	2									
2(c)(iii)	Butane / methylpropane AND because C_4H_{10} gives M_r close to calculated value in (c)(ii)	1									
2(d)(i)	M1: Use a balance which records to more than 2 d.p. M2: Use a measuring cylinder (or gas syringe) AND with smaller divisions / greater resolution	2									
2(d)(ii)	keep the collected gas / pressurised cylinder away from sources of ignition	1									
2(d)(iii)	M1: the gradient would be smaller / less / less positive M2: (As ' M_r ' is lower), for a particular mass, volume would be greater (so the gradient / density would be lower) OR M2: (As ' M_r ' is lower), for a particular volume, mass would be lower (so the gradient / density would be lower)	2									
2(d)(iv)	Temperature change will alter gas volume OR Temperature must be constant to allow comparison between results	1									
2(e)(v)	the experiment could be repeated and a mean value obtained	1									

2 Assessment of Planning Skills

- (a) Give one mark for a diagram showing apparatus suitable for heating caesium nitrate, collecting and measuring the volume of gas given off.

	Heating		Collection	
** Do not accept any apparatus that has sharp corners	test-tube	✓	(gas)-syringe	✓
	boiling-tube	✓	inverted measuring cylinder full of water	✓
	combustion-tube	✓	inverted burette full of water	✓
	round-bottomed flask**	✓	eudiometer	✓
	beaker**	✗	uncalibrated gas jar	✗
			uncalibrated test-tube/boiling-tube	✗

Do not give this mark if the collection apparatus is inverted and full of water but shows no graduations unless it has been correctly labelled. No mark should be given if solution or solid + water is heated.

Give one mark for correctly labelling the apparatus and indicating the volume of apparatus used to collect the gas, e.g. 100 cm³ gas syringe, 250 cm³ measuring cylinder.

2

- (b) Give one mark for nitrogen dioxide and oxygen if gas is not collected over water or for oxygen alone if the gas is collected over water.

1

- (c) Give one mark for a calculated M_r of caesium nitrate = 195.0

If the Candidate has chosen NO₂ and O₂ as the gas collected.

Give one mark for stating or showing by calculation that the greater volume of gas will be given by the first equation.

Give one mark if the mass of CsNO₃ is shown by calculation to be ≤ 0.65 g / 100 cm³ gas and the mass used will not give more gas than can be collected in the apparatus selected.

If the Candidate has chosen O₂ as the only gas collected.

Give one mark for stating or showing by calculation that the greater volume of gas will be given by the second equation.

Give one mark if the mass of CsNO₃ is shown by calculation to be ≤ 1.625 g / 100 cm³ gas and the mass used will not give more gas than can be collected in the apparatus selected.

3

- (d) Give one mark for stating that moles of gas and moles of CsNO₃ need to be calculated.

Give one mark for reference to numerical mole ratios from equations (if first mark has been given)

2

- (e) Give one mark for a suitable safety feature with associated reason, e.g. use of fume cupboard as NO₂ is toxic.

1

Total for Question 2 is 9

Total for Paper 30.

1 (a)	PLAN Problem	Selects the second equation The answer must be comparative . Cs or Cs ⁺ is larger/more electropositive/has less polarising power than Na or Li. Accept as a minimum requirement 'the ionic radius increases <u>down the group</u> '.	[1] [1]
(b) (i)	PLAN Problem	Amount/mass/weight/moles of CsNO ₃ identified as independent variable. Do not accept concentration or volume.	[1]
(ii)		Volume/amount/mass of gas collected identified as the dependent variable. Alternatively accept mass of residue.	[1]
(c)	PLAN Methods	Give one mark for a suitable apparatus for heating the solid to effect decomposition. Heating needs to be present and labelled but the word 'heat' with or without an arrow is sufficient. The use of a water-bath negates. Give a second mark for apparatus to collect and measure the volume of the gas. The volume of the apparatus must be given. (Maximum volume 5 dm ³). If a gas jar or test tube is used, it must be graduated, even if its total volume is given. Deduct one mark if these two criteria are fulfilled but the two items of apparatus are not connected. If there is a further item of apparatus between the heating and collection <u>it must work otherwise</u> treat it as a 'no connection'. Allow gases from both equations or a chosen one consistent with dry or wet conditions. i.e. O ₂ alone or a mixture of O ₂ /NO ₂ justified for apparatus used and the equation chosen. If the gas is collected over water, only O ₂ is acceptable. This mark depends on there being a gas collection device.	[1] [1] [1]
(d)	PLAN Problem	Calculates correctly the volume of gas to be expected from 1 mole of CsNO ₃ <i>LiNO₃ equivalent</i> 30 dm ³ (NO ₂ + O ₂) – gas syringe 6 dm ³ (O ₂) – over water <i>NaNO₃ equivalent</i> 12 dm ³ (O ₂) – either method Units must be given. <u>This mark is for the result not the method.</u>	[1]
(e)	PLAN Methods	Calculates CORRECTLY maximum mass to use. Accept a min. of 1.d.p. <i>LiNO₃ equivalent</i> $\frac{\text{collected volume in dm}^3}{30} \times 195$ for (NO ₂ + O ₂) $\frac{\text{collected volume in dm}^3}{6} \times 195$ for (O ₂) <i>NaNO₃ equivalent:</i> $\frac{\text{collected volume in dm}^3}{12} \times 195$ for (O ₂)(100cm ³ are evolved from 1.625g) The M _r (195) must be used in the calculation. A volume, which might have been omitted from (c), could be introduced here but there is no retrospective mark back to (c).	[1]

(f)	(i)	PLAN Methods	Give one mark for; uses a known mass/weight of solid.	[1]
	(ii)		Give one mark for; measures the initial and final volumes.	[1]
	(iii)		Give one mark for; Collects gas until volume collected is constant or no movement of syringe or no bubbles in water are seen. Deduct one mark if these steps are not in the correct chronological order.	[1]
(g)		PLAN Methods	Recognises that gas needs to be cooled to room temperature before measuring its volume or repeats the exercise.	[1]
(h)		PLAN Methods	Identifies a potential risk. NO ₂ poisonous; O ₂ an oxidant; CsNO ₃ is an oxidant; CsNO ₂ is poisonous; Potential suck back if collecting over water <u>Ignore items such as 'hot apparatus'</u> <u>OXYGEN FLAMMABLE negates</u> Suggests way of minimising risk.	[1]
			NO ₂ – work in fume cupboard O ₂ – remove any oxidisable material Suck Back – remove delivery tube from water when heating stops.	[1]
Qn 1		Total		[15]

Topic Chem 27 **Gas volume Q# 51/** ALVI Chemistry/2011/s/TZ 1/ Paper 5/Q# 1/www.SmashingScience.org

1	(a)	PLAN Problem	Predicts that the higher A _r elements/M _r compounds decompose less easily.	[1]
			Distortion/polarisation decreases. Accept reverse argument if related to correct group/M _r /A _r trend.	[1]
			Any graph showing a decreasing rate (not time) with M _r (bar chart or any line). Axes must be labelled (accept group II carbonate). Ignore units. Allow consequential graph answer from incorrect prediction.	[1]
(b)		PLAN Problem	(i) Element/carbonate as the independent variable. Mass negates.	[1]
			(ii) Time identified as dependent variable/ rate (of reaction) or equivalent.	[1]
(c)		PLAN Methods	Diagram to show only experimental setup	
			(i) Any suitable closed container and heat (no baths). (ii) Syringe labelled with the volume (10 cm ³ to 1000 cm ³). Or inverted measuring cylinder/burette (10 cm ³ to 1000 cm ³). Must be calibrated.	[1] [1]

(d)	PLAN Methods	(i) Statement of the gas volume. Minimum 10cm ³ . Exceeding capacity negates. If the diagram has a syringe/cylinder < 10cm ³ which loses the mark in (c), then allow a reasonable measured volume in (d) including up to the syringe/cylinder volume.	[1]
		(ii) An indication that the mass of each carbonate used must contain the same number of moles. A generalised mole calculation is acceptable.	[1]
		(iii) Having the same settings on the Bunsen (strength).	[1]
		Bunsen at the same distance from the reaction vessel.	[1]
(e)	PLAN Methods	Reference to 'hot' apparatus not any heating equipment.	[1]
		Heat proof gloves/handling devices/cool before handling.	[1]
		Accept sucking back and removing delivery tube.	
(f)	PLAN Methods	1. element/carbonate and 4 rows 2. time to chosen point and rate /1/t/1/time 3. Units (/s, /seconds), (/s ⁻¹), (/1/s) All correct 2 marks; One error 1 mark; Two or more errors, zero. If 1 column missing but all rest correct award 1 mark.	[2]
(g)	ACE Evaluation	Has to have a change to the apparatus. Regulated heating device/electrical hotplate/time to complete decomposition (syringe stops moving/or equivalent)/gravimetric mass loss in a set time. Change to a smaller reaction vessel e.g. conical to boiling tube/collecting in a syringe rather than over water to combat solubility not suck back. A larger syringe/cylinder to collect a larger volume (less proportion of displaced air).	[1]
	Total		[16]

SMASHING!!!

1	(a) (i)	$2\text{Mg}(\text{NO}_3)_2 \rightarrow 2\text{MgO} + 4\text{NO}_2 + \text{O}_2$ allow correct multiples	[1]
	(ii)	40.3g MgO, 48.0dm ³ NO ₂ , 12.0 dm ³ O ₂ Units must be given allow ecf from equation in (i)	[1]
	(b) (i)	Directly heated vessel labelled (magnesium) nitrate(V) with tube at exit Gas stream led into a liquid labelled alkali which will absorb the nitrogen(IV) oxide /NO ₂ Collects a gas in a syringe or over a liquid, provided it is properly connected All parts of the apparatus are connected and air-tight AND nitrogen(IV) oxide absorption precedes oxygen collection.	[1] [1] [1] [1]
	(ii)	States a collector volume with unit AND Correct calculation of mass of magnesium nitrate(V) to a volume that would fit the stated volume of collector. allow ecf on (a)(i) Units of volume and mass required.	[1]
	(c)	Mass of magnesium nitrate(V) (at start) and mass of magnesium oxide (at end). Or Mass of heated tube and contents before and after heating and mass of empty tube Mass of container (+ alkali) at start and mass at end Volume of oxygen	[1] [1] [1]
	(d) (i)	Heat to constant mass OR heat to constant volume	[1]
	(ii)	Let the apparatus cool (to room temperature)	[1]
	(e)	Use experimental results to produce moles of magnesium nitrate(V) AND moles of one of the three products. compare with molar ratio in equation as given in (a)(i)	[1] [1]
	(f)	Make sure all apparatus is airtight/no leakage before heating allow other sensible suggestions regarding exposure to nitrogen(IV) oxide or use of apparatus	[1]

ASSESSMENT OF PLANNING SKILLS

Look for the following points in any part of the plan or carrying out of the plan and award **one mark** for each point

- (i) Weighs a sample, adds to known volume of water and measures change in temperature.
- (ii) Calculates energy change for volume of solution used *Numerical answers are required in parts (ii) to (iv).*
- (iii) Converts mass NaHCO_3 into moles.
- (iv) Calculates ΔH_4 including sign (*unless already penalised*).
- (v) Adds 2 ΔH_4 to the answer to (g).
Ignore any reference to ΔH_5 and ΔH_6 etc. by the candidate

Total for Question 1: 25

Question 2**ASSESSMENT OF PLANNING SKILLS****GRID 1A**

Adds $\text{HCl}/\text{H}_2\text{SO}_4$ or any soluble chloride or soluble sulphate (or KI) to all three solutions	✓	No precipitate formed with FB 5 and with FB 6 (No change or no reaction acceptable)	✓
		White precipitate (yellow with KI) forms with FB 7 Indicated the presence of Pb^{2+}	✓
(Aqueous) ammonia added to the two solutions where no precipitate formed with the first reagent (FB 5 and FB 6) <i>This mark is lost if 2nd reagent is added to all three solutions</i>	✓	FB 5 gives a white precipitate soluble in excess ammonia Indicates the presence of Zn^{2+} FB 6 gives a white precipitate insoluble in excess ammonia Indicates the presence of Al^{3+}	✓
			5

GRID 1B

Adds aqueous ammonia to all three solutions	✓	White precipitate formed with all three solutions	✓
		White precipitate formed in FB 5 dissolves in excess ammonia solution. Indicates the presence of Zn^{2+}	✓
Adds $\text{HCl}/\text{H}_2\text{SO}_4$ or any soluble chloride or soluble sulphate (or KI) to the two solutions where the precipitate formed with aqueous ammonia did not dissolve in excess of the reagent. <i>This mark is lost if 2nd reagent is added to all three solutions</i>	✓	FB 7 gives a white precipitate (yellow with KI) Indicates the presence of Pb^{2+} There is no precipitate/no change/no reaction with FB 6 Indicates the presence of Al^{3+}	✓
			(5)

GRID 2A

Adds Na ₂ CO ₃ or NaHCO ₃ to all three solutions	✓	White precipitates formed with all three solutions	✓
		Effervescence or CO ₂ or gas turning lime water milky with FB 6	✓
		Indicates the presence of Al ³⁺	
(Aqueous) ammonia added to the two solutions where no effervescence was seen with the first reagent (FB 5 and FB 7) <i>This mark is lost if 2nd reagent is added to all three solutions</i>	✓	FB 5 gives a white precipitate soluble in excess ammonia Indicates the presence of Zn ²⁺	✓
		FB 7 gives a white precipitate insoluble in excess ammonia Indicates the presence of Pb ²⁺	

GRID 2B

Adds Na ₂ CO ₃ or NaHCO ₃ to all three solutions	✓	White precipitates formed with all three solutions	✓
		Effervescence or CO ₂ or gas turning lime water milky with FB 6	✓
		Indicates the presence of Al ³⁺	
Adds HCl/H ₂ SO ₄ or any soluble Chloride or soluble sulphate (or KI) to the two solutions where no effervescence was seen with the first reagent (FB 5 and FB 7) <i>This mark is lost if 2nd reagent is added to all three solutions</i>	✓	FB 7 gives a white precipitate (yellow with KI) indicates the presence of Pb ²⁺ There is no precipitate/no change/no reaction with FB 5 Indicates the presence of Zn ²⁺	✓

(5)

GRID 3A

Adds HCl/H ₂ SO ₄ or any soluble chloride or soluble sulphate (or KI) to all three solutions	✓	No precipitate formed with FB 5 and with FB 6 (No change or no reaction acceptable)	✓
		White precipitate (yellow with KI) forms with FB 7	✓
		Indicates the presence of Pb ²⁺	
Adds Na ₂ CO ₃ to the two solutions where no precipitate was seen with the first reagent (FB 5 and FB 6) <i>This mark is lost if 2nd reagent is added to all three solutions</i>	✓	FB 5 gives a white precipitate Indicates the presence of Zn ²⁺	✓
		FB 6 gives a (white precipitate and) effervescence, CO ₂ or a gas giving white precipitate with lime water. Indicates the presence of Al ³⁺	

5)

GRID 3B

Adds aqueous ammonia to all three solutions	✓	White precipitate formed with all three solutions	✓
		White precipitate formed in FB 5 dissolves in excess ammonia solution. Indicates the presence of Zn^{2+}	✓
Adds Na_2CO_3 or $NaHCO_3$ to the two solutions where the precipitate formed with aqueous ammonia did not dissolve in excess of the reagent (FB 6 and FB 7) <i>This mark is lost if 2nd reagent is added to all three solutions</i>	✓	FB 7 gives a white precipitate Indicates the presence of Pb^{2+} FB 6 gives a (white precipitate and) effervescence, CO_2 or a gas giving white precipitate with lime water. Indicates the presence of Al^{3+}	✓

(5)

NB:

“Method marks” may be awarded from the plan (page 8) or from the observation table (page 9).

Observation marks are awarded from page 9.

Marks are given for positive experimental identification – not for identification by elimination UNLESS the tests have been fully explained in theory in the Plan on page 8.

Reduce the marks awarded by one for each additional reagent used.

Ignore ions listed in the conclusion.

Total for Question 2: 5

Total for Paper: 30

1 (a)	PLAN Problem	Predicts a direct proportionality. Accept statements such as 'no. of moles of the precipitate/PbCl ₂ will increase (as the number of moles of NaCl increases)'. Equation shows a 1 to 2 molar ratio or wtte. (If a 'plateau' graph is described for the first mark allow a correctly explanation for the second mark i.e. all the lead nitrate has been used up)	[1] [1]
(b)	PLAN Method & Problem & ACE	All the lead nitrate was used up; moles or concentration of lead nitrate; total volume of lead nitrate. NOT amount A diagonal straight-line going through the origin. The line will abruptly change to a horizontal line Possible alternatives: <ul style="list-style-type: none"> • Diagonal line only, with +ve slope from the origin – 1 mark • Diagonal line not starting at the origin with a horizontal line – 1 mark • Curve from the origin with decreasing gradient and horizontal straight-line – 1 mark • Curve not from the origin with decreasing gradient and horizontal straight-line – 0 marks • Any lines showing an increase in gradient – 0 marks 	[1] [1] [1]
(c)	PLAN Problem	Independent variable – volume/mass/moles of NaCl Dependent variable – moles/mass of PbCl ₂ / ppt Other variables – temperature. NOT amount and NOT concentration of the NaCl. Three points correct – 2 marks Two points correct – 1 mark Any incorrect suggestions cancel correct suggestions	[2]



(d)	(i)	PLAN Method	<p>Calculating an appropriate mass of lead nitrate; this should be 8.275(8.3)g</p> <p>Dissolving the solid in water (or stirring) in a beaker or other appropriate vessel (<u>volumetric/graduated/dilution</u> flask) using less than 250 cm³</p> <p>Adding to the <u>volumetric/graduated/dilution</u> flask and adding water to the 250 cm³ mark (if 250 cm³ of water are added directly to a <u>volumetric/graduated/dilution</u> flask (containing the solid of course) allow 1 mark)</p> <p>Any dilution from a 'given' solution of lead nitrate gets 0 marks out of 3.</p> <p>Synthesis of the lead nitrate from lead and nitric acid scores zero.</p>	[1]
	(ii)		<p>A student who uses 33.1 grams of lead nitrate to make up correctly 1 dm³ of solution can gain the first two marks, but to gain the third mark a measured 250 cm³ needs to be taken using an appropriate measuring vessel.</p> <p>Apparatus for volume measurement (burette/pipette/measuring cylinder)(not a syringe) used to measure 50 cm³ or less of lead nitrate and 100 cm³ or less of sodium chloride (mention of only one measuring vessel is enough for this mark)</p> <p>Method for drying the precipitate (adding propanone and allowing to evaporate/pressing with filter paper/warm oven/sun leaving out to dry. NOT heat or the use of a Bunsen or microwave.</p>	[1] [1]
(e)		PLAN Method	<p>Table needs</p> <ul style="list-style-type: none"> volumes of lead nitrate, sodium chloride and mass/weight of lead chloride/ppt with appropriate data (volumes must total no more than 250 cm³ in each case) moles of sodium chloride and lead chloride/ppt correct units throughout (/cm³, /cm³ and /g [accept grams]; accept () instead of /) (these are for the items in bullet point one) <p>Normally there will be 5 sets of volumes with the volume of lead nitrate being constant. (no figures are required for the mass of the ppt) (allow 4 sets if the volumes are different to those in (d)). Ignore; volumes of water; units in the mole columns; items such as filter paper; numbers in the mole columns.</p> <p>Do not allow; n for the number of moles; zero for the volume of lead nitrate or sodium chloride.</p>	[1] [1] [1]
(f)		PLAN Method	<p>The drying process should be repeated to constant mass</p> <p>Allow heat/reheat to constant mass/weight.</p>	[1]
		Total		[16]

2 Three basic plan methods have been identified.

METHOD A - Preparing a solution by dissolving solid in hot water and cooling to saturate

METHOD B - Preparing a solution at room temperature

METHOD C - Preparing a solution from weighed solid and weighed/measured water

and

Three additional methods for determining the solubility

METHOD D - Titration method

METHOD E - Cooling curve

METHOD F - Filtrate method when a fixed mass of water is used in the experiment

IN EACH METHOD:

Record the letter of the marking point in the script at the point where it is given and place a tick in the grid in the margin.

Each point scores one mark — count the ticks and record the total below the grid.

Candidates employing different methods for making the saturated solution and for determining the solubility will be seen frequently. Mark each using the appropriate section of the mark scheme.

In all calculation sections, allow answers that are in g/100g water, g/g water, g/100 cm³ water or g/cm³ of water.

If the preparation of the saturated solution can be marked using different methods, award the marks for the method that benefits the candidate.

Many of the methods of determining solubility contain small errors that are not penalised (e.g. water that is lost in filter papers or on wet, filtered solid)

METHOD A

(a) PREPARATION OF THE SATURATED SOLUTION

Marking point

- (a) Heating water above room temperature
- (b) Dissolving (enough) solid (so that)
- (c) Solid forms on cooling 3

DETERMINATION OF THE 'SOLUBILITY'

- (d) Weighing a sample of the saturated solution
- (e) Evaporating all of the water
- (f) Weighing the solid remaining
- (g) Using specimen results (numerical or algebraic) to calculate the solubility 4

METHOD B

(a) PREPARATION OF THE SATURATED SOLUTION

Marking point

- (a) Add solid to water (until)
- (b) Solid remains undissolved/no more dissolves (Implied by filtering)
- (c) Allow to stand/leave for a long time (to establish equilibrium) 3

DETERMINATION OF THE 'SOLUBILITY'

METHOD B1

- (d) Weighing a sample of the saturated solution
- (e) Evaporating all of the water
- (f) Weighing the solid remaining
- (g) Using specimen results (numerical or algebraic) to calculate the solubility

METHOD B2 (for a known mass of water when making saturated solution)

- Weighing an empty container (and adding the filtrate)*
- Evaporating all of the water
- Weighing the solid remaining
- Using specimen results (numerical or algebraic) to calculate the solubility

4

METHOD C

(b) PREPARATION OF THE SATURATED SOLUTION

Marking point

- (a) Weigh or state mass of solid and measure or state mass/volume of water
- (b) Dissolve solid until undissolved solid remains (Implied by filtering) (*If heated during preparation, solid forms on cooling*)
- (c) Allow to stand/leave for a long time (to establish equilibrium)

3

DETERMINATION OF THE 'SOLUBILITY'

METHOD C1

- (d) Filter the solution/separate solid from solution (e.g. decant)
- (e) Dry the residue
- (f) Weigh the residual solid
- (g) Using specimen results (numerical or algebraic) to calculate the solubility.

METHOD C2 (where solid is added in small weighed quantities)

- The mass of each small sample has been measured
- Number of samples dissolved is recorded
- Weighs solid from the final sample that is not added to the solution (as solution becomes saturated)
- Using specimen results (numerical or algebraic) to calculate the solubility.

4

METHOD D - TITRATION METHOD FOR DETERMINATION OF THE 'SOLUBILITY'

Only (d) may be awarded for a straight titration of KClO_3 with HCl

- (d) Accurately measure a volume (pipette/burette) of and weigh the measured volume of the saturated solution
- (e) (i) React with (excess) KI and acid
or
(ii) *(React with (excess) hydrochloric acid)*
- (f) (i) Titrate iodine formed with thiosulphate
or
(ii) *(Titrate excess acid with sodium hydroxide)*
- (g) Using specimen results (numerical or algebraic) to calculate the solubility. 4

METHOD E - COOLING CURVE METHOD FOR DETERMINATION OF SOLUBILITY

- (d) (i) weighing samples of solid with a different mass for each experiment
or
(ii) *(Maintaining a fixed mass of solid in each experiment)*
- (e) (i) Having a fixed mass/volume of water in each experiment
or
(ii) *(Varying the mass/volume of water in each experiment)*
- (f) Noting the temperature at which crystals form from hot solution for at least 5 variables
- (g) Showing an appropriate calculation to obtain solubility data for one of the experiments,
and
Indicating that a solubility temperature graph would be drawn,
and
The solubility at room temperature to be read from the graph 4

METHOD F - METHOD FOR DETERMINATION OF SOLUBILITY WHERE CANDIDATES START WITH A KNOWN MASS OF WATER

- (d) Weigh container, e.g. a beaker
- (e) Filter the saturated solution into the weighed beaker
- (f) Weigh the beaker + saturated solution

(g) Calculate the mass of solute in the known mass of water and hence determine the solubility 4

(b) Variation of sodium bromide 'Solubility' with temperature

Give **one mark** if both axes have linear numerical scales and points are plotted in at least 5 "large" squares in either direction.

Give **one mark** if two appropriate lines (straight lines or curves - but no s shaped curves) have been drawn through the plotted points.

The two lines do not have to intersect.

Do **not** give this mark if there is an obvious error in the plotting of any point or there is a "rounding" of any line to connect the two or to force a fit to the plotted point at 50°C

Give **one mark** for an appropriate transition temperature, read from the graph to within $\frac{1}{2}$ small square.

This mark is independent of the previous mark.

To award this mark there must be an intersection of two lines and not a rounded point of inflexion.

Do **not** give this mark if additional graph lines have been drawn.

[The published transition temperature is 50.7°C]

Total for Question 2 = 10

Total for Paper = 30

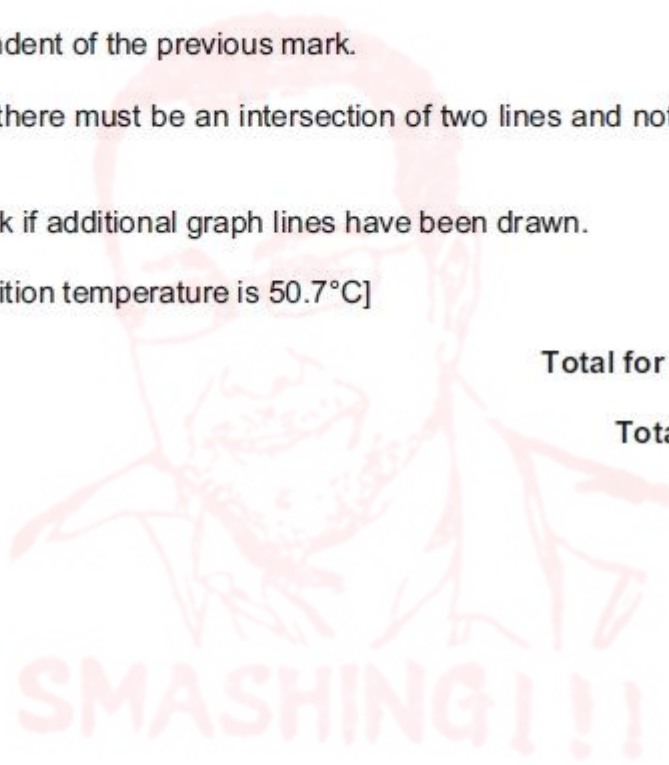

2	(a)	ACE Evaluation	Accept anomalous values 90.6 / 97.8 only. Accept these indicated in the table. <i>(Column 2 at 60% and column 4 at 100%)</i>	[1]
	(b)	ACE Data	Correctly calculates the % composition for each mixture. Ignore d.p. or s.f. Correctly calculates a mean boiling temperature for each mixture. Also accept if any / all anomalies are included. Values to at least 1 decimal place. <i>(See appendix)</i>	[1] [1]
	(c)	ACE Data	Selects suitable scales for both graphs (at least half grid and linear, axes to be labelled). Check points for both graphs. <i>All points to be plotted within ½ small square in either direction</i> Draws straight line through points for the alcohols graph and suitable curve for ethanol / cyclohexane. If points are incorrectly plotted these may become 'lines of best fit'. For the second plot accept a line that includes the 50% point or runs smoothly below it. Mark the 3 points on each graph and award marks All 6 points correct max 3 marks 4, 5 points correct max 2 marks 2, 3 points correct max 1 mark	[1] [1] [1]
	(d)	ACE Conclusions	Endothermic AND More energy required to break intermolecular forces than is released by making new ones. OR Solution has fewer / weaker intermolecular forces. OR Solution has lower boiling-point (than expected) OR Solution is a more volatile liquid. OR Reduced forces holding molecules together. Accept bonds between molecules, but not bonds alone. Bonds alone is neutral (no CON). Refers correctly to hydrogen bonds in ethanol and Van der Waals forces in cyclohexane. (Van der Waals forces in ethanol neutral). Refers to Van der Waals forces only between cyclohexane and ethanol in the mixture. Accept induced dipole / dipole. Not induced (single) dipole.	[1] [1] [1]
		Total		[9]

2 (a)

volume / cm ³		temperature of boiling mixture / °C				% (by volume) of propan-1-ol in mixture	mean boiling temperature / °C
propan-1-ol	propan-2-ol	1	2	3	4		
0	20.00	82.1	82.6	82.7	82.2	0	82.4
4.00	16.00	85.3	85.4	85.5	85.4	20.0	85.4
8.00	12.00	88.5	88.4	88.1	88.2	40.0	88.3
12.00	8.00	91.3	90.6	91.2	91.4	60.0	91.3 (91.125)
16.00	4.00	94.2	94.0	94.3	94.3	80.0	94.2
20.00	0	97.1	97.3	97.2	97.8	100.0	97.2 (97.35)

Shaded cells are those most likely to be omitted when calculating mean.

3 (a)

student	mass of crucible and lid / g	mass of crucible and lid + magnesium / g	mass of crucible and lid + magnesium oxide / g	mass of magnesium / g	mass of magnesium oxide / g
1	25.37	26.62	27.50	1.25	2.13
2	25.18	27.01	28.19	1.83	3.01
3	25.44	27.73	29.19	2.29	3.75
4	25.26	27.71	24.96	2.45	-0.30
5	25.39	28.11	29.84	2.72	4.45
6	25.04	27.89	28.54	2.85	3.50
7	25.13	28.08	29.93	2.95	<u>4.80</u>

1(a)	Surrounding vessel of polystyrene / styrofoam / plastic containing water and Ice within the cooling mixture	1																
1(b)(i)	Add dropwise around 20.00 g mark	1																
1(b)(ii)	M1 Volume of cyclohexane $20.00 / 0.78 = 25.64 \text{ cm}^3$ M2 No And A burette can only measure $\square 0.05 \text{ cm}^3$ Or A burette cannot measure to 0.01 cm^3	2																
1(b)(iii)	When transferring X, some may remain in the container Or It is not weighing by difference'	1																
1(c)(i)	M1 values M2 3 sf <table border="1" style="margin-left: auto; margin-right: auto;"> <tbody> <tr><td>1</td><td>0.0125</td></tr> <tr><td>2</td><td>0.0200</td></tr> <tr><td>3</td><td>0.0250</td></tr> <tr><td>4</td><td>0.0400</td></tr> <tr><td>5</td><td>0.0475</td></tr> <tr><td>6</td><td>0.0575</td></tr> <tr><td>7</td><td>0.0650</td></tr> <tr><td>8</td><td>0.0700</td></tr> </tbody> </table>	1	0.0125	2	0.0200	3	0.0250	4	0.0400	5	0.0475	6	0.0575	7	0.0650	8	0.0700	2
1	0.0125																	
2	0.0200																	
3	0.0250																	
4	0.0400																	
5	0.0475																	
6	0.0575																	
7	0.0650																	
8	0.0700																	
1(c)(ii)	M1 Points plotted M2 Line of best fit	2																
1(c)(iii)	Reading 8 and A greater mass than 1.40 g was added	1																
1(c)(iv)	M1 B = 0.045(0) M2 = M1 $\square 20.00 = 0.90 \text{ g}$	2																
1(c)(v)	M1 = Co-ordinates M2 = correct gradient calculation	2																
1(d)	Correct calculation of $[20.020 / 1 \text{ cv}] =$	1																
1(e)	$\text{C}_6\text{H}_5\text{---CH}_2\text{---COOH}$ Or $\text{CH}_3\text{---C}_6\text{H}_4\text{---COOH}$	1																

1 (a)	reagent added	reagent added	reagent added		
	sulfuric acid	(excess, aqueous) ammonia	sulfuric acid		
	substances present at the end of the reaction	substances present at the end of the reaction	substances present at the end of the reaction		
	zinc sulfate AND aluminium sulfate(copper)	zinc (tetra) ammine (ions) (aluminium hydroxide)	ammonium sulfate (zinc hydroxide)		
	substances removed by filtration	substances removed by filtration	substances removed by filtration		
	copper	aluminium hydroxide	zinc hydroxide		
Allow: Correct formulae or ions instead of names.					[5]
(b)	Step 1: Sufficient/ enough /excess sulfuric acid (to dissolve the zinc and aluminium)			1	
	Step 2: Sufficient/ enough/ excess aqueous ammonia (to precipitate aluminium hydroxide and to completely dissolve the zinc hydroxide)			1	
	Step 3: Sufficient/ enough/ sulfuric acid to:			1	
	neutralise/ react with ammonia (re-) precipitate the zinc hydroxide but not so much that the zinc hydroxide reacts/ dissolves			1	
					[4]
(c)	Heat (the hydroxides)			1	
	To constant mass			1	
					[2]
(d)	Measure mass of any three of solder, copper, zinc oxide/hydroxide and aluminium oxide/hydroxide or residues/ precipitates			1	
	The copper should be washed (with water /propanone or any other suitable organic solvent) and dried			1	
					[2]
(e)	0.794g			1	[1]
(f)	The mass/amount/percentage of copper is small			1	[1]

2(a)	$Ag^+(aq) + Cl^-(aq) \rightarrow AgCl(s)$	1
2(b)(i)	M1 (buchner) funnel (with filter paper) M2 sealed with a cork around the funnel	2
2(b)(ii)	increased rate (of filtration)	1
2(c)(i)	warm / heat to constant mass	1
2(c)(ii)	(5.736 g AND 5.736 / 143.4 =) 0.04(00)	1
2(c)(iii)	M1 mol of $MC_2 = 0.04 / 2 = 0.02(00)$ M2 molar mass of $MC_2 = 3.172 / 0.02 = 158.6$ M3 A_r of M = $158.6 - 71.0 = 87.6$ and Sr	3
2(c)(iv)	increase because tap water contains chloride ions	1

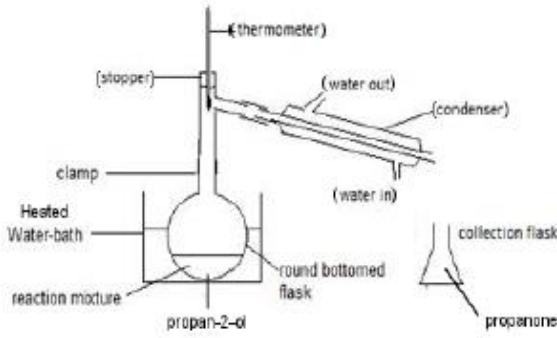
2(a)(i)	M1 M_r propan-2-ol is $36 + 16 + 8 = 60$ and n propan-2-ol = $5 / 60 = 0.0833(3)$	1
	M2 n $K_2Cr_2O_7 = 0.0833 \div 3 = 0.0278$ M_r $K_2Cr_2O_7 = 78.2 + 104 + 112 = 294.2$ Mass = $294.2 \times 0.0278 = 8.16953333 = 8.17$ g	1
2(a)(ii)	 <p>Marks awarded for correctly labelled diagram showing the following:</p> <ul style="list-style-type: none"> <input type="checkbox"/> Thermometer in the correct position <input type="checkbox"/> Condenser showing coolant <input type="checkbox"/> Sealed apparatus around the round bottomed flask and thermometer. No seal around collection flask. <p>Three points shown, award 2 marks Two points shown, award 1 mark</p> <p>Propan-2-ol and propanone in correct locations, award 1 mark</p>	3
2(a)(iii)	Propan-2-ol is flammable AND should not be heated directly / keep away from a naked flame / Bunsen burner	1
2(a)(iv)	Reagent: sodium carbonate / an alkali	1
	Explanation: carbonate added until no further effervescence / alkali added until indicator shows neutral / not acidic OR use an indicator to test when neutral / for a base/metal – (added until) some solid remains	1
2(b)(i)	It is faster / precipitate is drier (a comparison is required)	1
2(b)(ii)	Return it to the oven for a further period of time / Repeat drying. Reweigh. AND Continue with this process until the mass is constant	1
2(b)(iii)	M1 Mass of propanone = $5 \times 0.789 = 3.945$ g only	1
	M2 M_r Propanone = 58	1
	M3 Moles propanone = $3.945 / 58 = 0.0680$ Expected yield = $0.0680 \times 238 = 16.184$ g (16.18810345) % yield = $11.84 / 16.20 \times 100 = 73$ % (73.14013058)	1
2(b)(iv)	The reaction does not go to completion / is reversible / is an equilibrium reaction	1

Page 2	Mark Scheme	Syllabus	Paper
	GCE A/AS LEVEL – October/November 2008	9701	05

<i>Skill</i>		<i>Breakdown of marks</i>	
Planning	15 marks	Defining the problem	5 marks
		Methods	10 marks
Analysis, conclusions and evaluation	15 marks	Dealing with data	8 marks
		Evaluation	4 marks
		Conclusion	3 marks

Statement Bank

PLANNING (PLAN)

Defining the problem (problem)

P1	identify the independent variable in the experiment or investigation
P2	identify the dependent variable in the experiment or investigation
P3	express the aim in terms of a prediction or hypothesis, and express this in words or in the form of a predicted graph
P4	identify the variables that are to be controlled

Methods (methods)

M1	describe the method to be used to vary the independent variable, and the means that they will propose to ensure that they have measured its value accurately
M2	describe how the dependent variable is to be measured
M3	describe how each of the other key variables is to be controlled
M4	explain how any control experiments will be used to verify that is the independent variable that is affecting the dependent variable and not some other factor
M5	describe the arrangement of apparatus and the steps in the procedure to be followed
M6	suggest appropriate volumes and concentrations of reagents
M7	assess the risks in their proposed methods
M8	describe precautions that should be taken to keep risks to a minimum
M9	draw up tables for data that they might wish to record
M10	describe how the data might be used in order to reach a conclusion

Page 3	Mark Scheme	Syllabus	Paper
	GCE A/AS LEVEL – October/November 2008	9701	05

ANALYSIS, CONCLUSIONS AND EVALUATION (ACE)

Dealing with data (data)

D1	identify the calculations and means of presentation of data that are necessary to be able to draw conclusions from provided data
D2	use calculations to enable simplification or explanation of data
D3	use tables and graphs to draw attention to the key points in quantitative data, including the variability of data

Evaluation (evaluation)

E1	identify anomalous values in provided data and suggest appropriate means of dealing with such anomalies within familiar contexts, suggest possible explanations for anomalous readings
E2	within familiar contexts, suggest possible explanations for anomalous readings
E3	identify the extent to which provided readings have been adequately replicated, and describe the adequacy of the range of data provided
E4	use provided information to assess the extent to which selected variables have been effectively controlled
E5	use these evaluations and provided information to make informed judgements on the confidence with which conclusions may be drawn

Conclusions (conclusions)

C1	draw conclusions from an investigation, providing a detailed description of the key features of the data and analyses, and considering whether experimental data supports a given hypothesis
C2	make detailed scientific explanations of the data, analysis and conclusions that they have described
C3	make further predictions, ask informed and relevant questions and suggest improvements

Skill	Total marks	Breakdown of marks			Question 1	Question 2
		Statement	Marks			
Planning	15 marks	Defining the <u>problem</u>	P	5	5	0
		<u>Methods</u>	M	10	10	0
Analysis, conclusions and evaluation	15 marks	Dealing with <u>data</u>	D	8	0	8
		<u>Evaluation</u>	E	4	0	4
		<u>Conclusion</u>	C	3	0	3

Question	Sections	Statement	Indicative material	Mark
1 (a)	PLAN Problem	(i) P3	The solubility of cerium sulphate decreases due to the common ion effect/Le Chatelier as the concentration of sulphuric acid increases.	[1]
		(ii) P3	Sketches an appropriate graph (slight curve or straight line) that matches the prediction in the first part of the section. (Graph to start on the y-axis but should not extend to the x-axis.) (Allow ecf graph from a prediction of increasing solubility – this graph to have a positive gradient beginning at a non-zero point on the y-axis)(do not allow ecf from a 'nonsense' statement)	[1]
(b)	PLAN Problem	P1	<u>Concentration</u> of sulphuric acid identified as independent variable.	[1]
		P2	Mass/moles of cerium sulphate dissolved identified as the dependent variable/solubility (accept other concentration units).	[1]
		P4	Temperature identified as the variable to be controlled. <u>(any other suggestion negates any or all of these points)</u>	[1]
(c) Part 1	PLAN Methods	M5	A. Describes a sequential method for preparing the saturated solution using all of the 60 cm ³ of <u>distilled water</u> , and filtering off <u>excess</u> (stated or by implication) solid. (To ensure saturation mention should be made of stirring/leaving the solution for some time/heating and cooling back to the controlled temperature).	[1]
		M3	B. Describes a practical method of controlling temperature e.g. use of a water bath.	[1]
		M5	C. There are several methods of dealing with this experiment. This could involve (i) weighing a sample of solution, an appropriate method for evaporating the water, and weighing the residual solid; (ii) weighing the water/solution (60 cm ³) with excess solid, filtering and then weighing the residue. (Ignore as not relevant any suggestion of water /moisture on the residue or filter paper.)	[1]
		M5	D. Shows how the mass of solid and water are converted to solubility. $\frac{\text{mass of solid (or figures)}}{60/\text{mass of water/eqn which gives mass}} \times 100$	[1]

Question	Sections	Statement	Indicative material	Mark
Part 2	PLAN Methods	M1	E. An appropriate method for diluting the sulphuric acid described. (Measurement by any means of each volume – acid and water [any volumes are acceptable].)	[1]
		M5	F. Burettes (and graduated flasks) or other suitable precision apparatus used to measure volumes.	[1]
		M6	G. Four or more solutions with different concentrations prepared (the range should cover at least a fourfold increase in concentration e.g. 1M to 4M and at least one should be greater than 2.5M. 5M could be one of these). (This mark can be accessed from the table in (e).)	[1]
		M6	H. Concentrations of the solutions specified (<u>minimum of three concentrations needed</u>) or relative volumes given (provided a minimum of 60 cm ³ of acid/solution is available).	[1]
(d)	PLAN Methods	M7	<u>Corrosive nature of sulphuric acid</u> identified as the hazard or any risk associated with this hazard. Alternatively, accept reference to the toxicity of cerium compounds or any risk associated with the use of this reagent.	[1]
(e)	PLAN Methods	M9	Draws up table to show concentration of acid or the appropriate volumes as in (c) Part 2 and either (i) mass of solid taken and the mass of the solid remaining undissolved or (ii) mass of water/acid solution/acid/solvent and the mass of the solution formed. Appropriate units should be recorded in the column headings. (If the dissolved salt is isolated and they know the mass of solvent/solution, this also would be appropriate.) (Ignore other columns even if nonsense.)	[1]
				[Total :15]

SMASHING!!!

(d)	ACE Data	One mark if the two anomalous points furthest from the line (one on each side) are circled. Allow only one anomaly if there is only one or all the anomalies are on the same side. In plotting the points, it is possible that some points will be a little way from the correctly drawn line. These in many cases are likely not to be 'ringed'. If 5 or more points are 'ringed' do not award this mark but allow any subsequent correct discussion.	[1]
		For each of the two different anomalies an appropriate explanation gains one mark. If the graph is plotted correctly point 3 will be above the line and point 7 below the line. POINT 3 ; temperature measured after freezing was complete (i.e. late); too much glucose added; reduced amount of water. POINT 7 ; temperature recorded before freezing was complete; not all glucose dissolved; too much water. If two correct suggestions are given but not 'tied' to a particular point award one mark. If the comments are assigned to the wrong points NO marks.	[2]
(e) (i)	ACE data	Appropriately drawn lines on the graph with correctly deduced intercepts.	[1]
		For a correct calculation from the candidates figures with correct units ($^{\circ}\text{C kg mol}^{-1}$) Since the results produce a good linear graph, the procedure is OK.	[1]
(ii)		Accept 'constant gradient', and references such as 'most of the points are close to the drawn line' etc. 'Line passing through the origin' is irrelevant.	[1]
(f)	ACE Data	The NaCl produces twice the number of particles. Allow the statement that NaCl produces Na^+ and Cl^- .	[1]
(g)	ACE Data	Between answers to (a) and (f).	[1]
	Total		[14]

A	B	C	D	E	F
mass of water /g	mass of glucose /g	freezing point depression $\Delta T_f / ^{\circ}\text{C}$	moles of glucose $\frac{B}{180}$	molality $D \times 10 \text{ mol/kg}$	
100	10.0	1.03	0.0556	0.556	
100	12.2	1.26	0.0678	0.678	
100	18.0	2.09	0.100	1.00	
100	23.3	2.40	0.129	1.29	
100	27.7	2.86	0.154	1.54	
100	30.9	3.22	0.172	1.72	
100	33.1	3.31	0.184	1.84	
100	38.6	3.98	0.214	2.14	
100	42.3	4.37	0.235	2.35	

2 (a)	ACE Data	<p>All these Marks are dependent on some 'numbers' being in the relevant columns.</p> <p>This mark is for any column, which is complete with correct title (e.g. mass of solid), equation and unit. [1]</p> <p>This mark is for at least one further column with at least two out of the three required headings. This could be awarded for a single column, which does not meet the first mark's criteria. [1]</p> <p>This mark is for a completed solubility column, which must be headed with either with the word solubility or a correct equation. [1]</p>	
(b)	ACE Data	<p>For the first two marks accept any scales provided they allow the points to be spread over more than half the graph in each direction.</p> <p>Give one mark if temperature is plotted on the x-axis and labelled with either the word temperature/temp or A/column A and units [$^{\circ}\text{C}$ or ($^{\circ}\text{C}$)]. If temperature is plotted on the y-axis then allow the x-axis to substitute for the y-axis and the remaining 3 marks could be gained. [1]</p> <p>If the y-axis is labelled solubility (or what the student believes is solubility) or a correct formula is given give a second mark. [1]</p> <p><u>OR If the y-axis is not labelled solubility</u> allow the second mark if the axis is labelled with a correct unit and either the correct formula or the correct name (e.g. mass of solute/mass of solid etc.) DO NOT NOW AWARD THE THIRD AND FOURTH MARKS.</p> <p>Check the plotting of the points at 45°C, 50°C and 55°C. If these are OK give a third, mark. If one or more of these points has not been plotted, check others as near as possible to the three chosen. [1]</p> <p>Give a fourth mark for drawing 2 intersecting lines, which are reasonable for the points plotted. Ideally, these will be curves but if straight lines are drawn these must be tangential to the expected curves near the intersection point. Additionally they must intercept at a point on the high temperature line, which is before the 70°C point. Do not accept a continuous curve. [1]</p>	
(c)	ACE Data	<p>Read the transition temperature from the graph (the intercept of any two lines) and then compare your reading with the candidate's value. Award the mark if within $\pm 0.5^{\circ}\text{C}$. Mark cannot be gained from a point of inflection. [1]</p>	

2 (a)	F	G	H solubility	
	D-C / g	C-B / g	[(F × 100)] / G / g / 100 g	
	1.25	25.00	5.00	
	1.25	20.00	6.25	
	5.00	25.00	20.00	
	7.76	19.40	40.00	
	11.11	23.00	48.30	
	11.75	25.00	47.00	
	9.62	21.00	45.81	
	9.10	20.00	45.50	
	11.25	25.00	45.00	
13.35	30.00	44.50		
	Heading for final column calculating the solubility is given correctly with units.	1		
	All data is to 2 decimal places. Allow 1 error.	1		
	Data in final column is correct. Allow 1 error in computation.	1		
(b)	The x-axis must start at zero and be labelled 'temperature / °C' OR T / °C and y-axis as 'solubility (of sodium sulfate) g/100g'. Plotted points must cover at least half the grid in both directions.	1		
	All 10 points plotted correctly.	1		
	First (left-hand) curve is smooth passing through (or extremely close to) all the points and does not deviate to accommodate a mis-plot or incorrect point. Curve intersects with a second curve at or above the candidate's solubility for experiment 5.	1		
	Second curve (right hand) is smooth passing through (or extremely close to) all the points and does not deviate to accommodate a mis-plot or incorrect point.	1		
(c)	the temperature is read correctly the solubility is read correctly	1 1		
(d) (i)	Cross is on the 40g / 100 g line and to the right of the point plotted at 30 °C.	1		
(ii)	Transition temperature would be higher as intersection of curves would be at a higher temperature.	1		
(e)	Solubility is 47.6 (g / 100g)	1		
	1.2% OR 1.21% OR 1.28% OR 1.3%	1		

(f)	<p>$\text{Na}_2\text{SO}_4 \cdot 10\text{H}_2\text{O}$ endothermic because solubility increases with increasing temperature (or reverse argument)</p> <p>Na_2SO_4 exothermic because solubility decreases with increasing temperature (or reverse argument)</p> <p>For endothermic and exothermic correctly assigned For providing the correct reasons</p>	<p>1 1</p>
		[Total: 15]

Topic Chem 28 **States of matter** Q# 67/ ALvl Chemistry/2012/s/TZ 1/ Paper 5/Q# 1/www.SmashingScience.org

1	(a) (i)	PLAN Problem	States that the moles of copper(II) hydroxide increase as the molar concentration of copper(II) sulfate increases and sketches a line from the origin with an initial positive gradient. Ignore any subsequent plateau or maximum on this line.	[1]
	(ii)		A straight line terminating at the point of saturation with marked co-ordinates: award 2 marks.	[1]
			A straight line clearly terminating within the grid but without marked co-ordinates: award 1 mark.	[1]
		A line (not necessarily straight) which does not terminate at the saturation point but with the co-ordinates marked: award 1 mark. This line can plateau after the saturation point.		
(b)	PLAN Problem	(i) concentration of copper(II) sulfate.		[1]
		(ii) moles of copper(II) hydroxide		[1]
(c)	PLAN Method	Indicates at least five experiments. These may be shown in the table in 1(e). Five blank rows in the table are acceptable.		[1]
		A range of concentrations over at least 0.8 mol dm^{-3} , which must cover 1.0 mol dm^{-3} , up to a maximum of 1.39. Accept a range of mass of copper(II) sulfate (with solution volume) that has been calculated satisfying the same concentration criteria.		[1]
		Filtering/centrifuging		[1]
		Method of drying and weighing the precipitate. Include washing with water (and propanone), (air) drying and weighing (to constant mass). Do not accept direct heating, blotting or a statement that the precipitate is simply left to dry.		[1]
		A suitable calculation of a molarity, even if greater than 1.39 (M_r of the copper(II) sulfate must be used). Check that the solution is made up to the appropriate volume and not that a mass is added to a fixed volume of water.		[1]

(d)	PLAN Method	Identifies that copper(II) sulfate is harmful/a danger to the environment.	[1]
		Identifies that sodium hydroxide is corrosive (from the hazard information).	[1]
		Give one mark for a precaution for either hazard of (chemical) resistant gloves or large dilution when disposing of chemicals.	[1]
(e)	PLAN Method	<p>This table must match the plan in 1(c). Five or four columns are required depending on whether serial dilution is used to prepare the solutions:</p> <p>Either (i) mass of copper(II) sulfate/g or (ii) volume of copper sulfate solution/cm³ and volume of water/cm³ for serial dilutions; mass/weight of copper(II) hydroxide/g; concentration of copper(II) sulfate/mol.dm⁻³; number of moles of copper(II) hydroxide (no unit).</p> <p>The full word for the unit can be used with or without / or (). Ignore other column headings and units.</p> <p>If Five or Four are fully correct, two marks; four or three correct, one mark; otherwise zero.</p>	[2]
			[Total: 15]



Question	Sections	Statement	Indicative material	Mark
2 (a)	ACE Data	D1	Labels additional columns: the charge passed through the electrolysis cell and the mass of copper deposited on the cathode. (Accept either a correct name or the correct equation.)	[1]
		D2	Appropriate units, however, must be given (accept 'Q' instead of charge). Must have two derived columns. Correct subtractions for the mass of copper deposited. (Allow 2 errors and 0 for 0.00, all data to 2 dp. If only the various intermediate masses are recorded, this second mark is not to be awarded.)	[1]
(b)	ACE Data	D3	A. Plots mass of copper deposited (y-axis) against charge passed (x-axis) with correct unambiguous labels and units. (Any other plot can access marks B, C and D)	[1]
		D3	B. Suitable scales selected – data to be plotted over more than half of each axis. This mark stands separate from A.	[1]
		D3	C. Line of best-fit drawn – passing through origin or through an intercept of 115.74. (Some part of the line drawn must cut/touch the origin or the 115.74 intercept.)	[1]
		D3	D. Check that all the points are on or very close to the line except the 1.75/5040 point whose plotting accuracy must be checked. If they are, award the mark. At least nine points must have been plotted. (For very unusual graphs, check the plotting of the first three points from the table.) The 'best' straight line is between the origin and the last point (2.40/7200). <u>Do not penalise the same unit error twice.</u>	[1]
			Plots of (i) mass difference vs time (ii) mass of cathode vs charge (iii) mass of cathode vs time can access the marks in 2(c), 2(d), 2(e) and 2(f).	
(c)	ACE Evaluation	E1	Identifies the single point that does not lie on the line of best-fit (1.75 g Cu at 5040 coulomb) (either by giving the figures here or by suitably marking the graph). If there is another more anomalous point due to erroneous plotting accept this point instead.) (If time has been plotted, allow this also if correctly dealt with.)	[1]
		E2	Suggests an appropriate reason. (Mass of copper is too high – <u>has some residual liquid on the copper</u>). The comment must relate to the position of the selected point. If no point is identified there is no second mark.	[1]

A	B	C	D	E
time /minutes	mass of cathode /g	mass of copper deposited (B -115.74) /g	time (A × 60) /seconds or /s	charge (D × 0.3) or (18A) /C
0	115.74	0.00	0.00	0.00
40	115.97	0.23	2400	720
80	116.22	0.48	4800	1440
120	116.46	0.72	7200	2160
160	116.70	0.96	9600	2880
200	116.94	1.20	12000	3600
240	117.19	1.45	14400	4320
280	117.49	1.75	16800	5040
320	117.67	1.93	19200	5760
360	117.92	2.18	21600	6480
400	118.14	2.40	24000	7200

Question	Sections	Statement	Indicative material	Mark
(d)	ACE Evaluation	E5	% error is decreased for the small masses involved.	[1]
(e)	ACE Data	D2	Enough construction lines on the graph to lead to the correct readings of the mass of copper and the charge.	[1]
		D2	Calculation of the correct answer (to 2 s.f. [however, allow the candidate to give the answer to no more than 5 s.f.]) corresponding to the readings from the graph. The reading should be within 50C and 0.01 g of the Examiners values. (An answer must be given – the correct value is about $9.5 \times 10^4 \text{ C mol}^{-1}$.)	[1]
(f)	ACE Conclusions	C1	Refers to <u>straight line</u> through origin (or 115.74) or few points off the line as supporting evidence.	[1]
		C1	If the candidate's answer is 9.5×10^4 to 2 sf allow the mark for comments referring to 'close agreement' with the real/given value etc. (must be comparative)	[1]
(g)	ACE Conclusions	C3	Candidate realised that the (loss in) mass of the anode could also have been measured and recorded. (Ignore all other suggestions.)	[1]
(h)	ACE Evaluation	E1	Any comment should refer to a decrease in the current or an increased resistance in the circuit.	[1]
				[Total: 15]

2 (a)	$[M^{n+}(aq)] / \text{mol dm}^{-3}$	EMF / V	$\log[M^{n+}(aq)]$	
	5.00×10^{-1}	0.94	-0.30	
	1.00×10^{-1}	0.96	-1.00	
	4.00×10^{-2}	0.97	-1.40	
	1.00×10^{-2}	0.99	-2.00	
	5.00×10^{-3}	1.00	-2.30	
	2.00×10^{-3}	1.01	-2.70	
	8.00×10^{-4}	1.02	-3.10	
	2.00×10^{-4}	1.04	-3.70	
	Correctly calculated values			[1]
	All data to 2 decimal places			[1]
(b)	All 8 points present and plotted correctly			[1]
	Best fit continuous straight line			[1]
(c)	There are no anomalous points			[1]
	Variations in points due to rounding.			[1]
	OR			
	Variations arise from being to just 2dp.			
(d) (i)	Appropriately drawn lines on graph			[1]
	Calculates correctly gradient of the graph			[1]
	Uses $-0.06/n = \text{gradient}$ to calculate $n = 2$			[1]
	Correct working must be shown			
(ii)	Extrapolates graph to obtain intercept on y-axis and deduces E^\ominus for the cell to a minimum of 2 dp e.g. (+)0.93(V)			[1]
	OR			
	Calculates a value for E^\ominus using the electrode potential expression and candidate's final value for n calculated in (d)(i) or candidate's gradient and a data point on the candidate's line.			
(e)	E^\ominus for M, $(0.80 - 0.93) = -0.13$ AND Metal is Pb (allow Sn on -0.14) allow ecf from (d)(ii)			[1]

(f)	$2\text{Ag}^+ + \text{Pb} \rightarrow 2\text{Ag} + \text{Pb}^{2+}$	[1]
(g) (i)	To allow movement of ions OR to maintain charge / ion <u>balance</u>	[1]
(ii)	If lead given in (e) then only potassium nitrate is suitable	[1]
	If potassium chloride given as unsuitable, then accept precipitations with silver OR lead (ions)	[1]
	If potassium sulfate given as unsuitable, then accept precipitations with lead (ions) ONLY	
	If tin given in (e) potassium sulfate or potassium nitrate are suitable precipitation would occur just with potassium chloride with silver (ions) ONLY	

Topic Chem 24 **Electrolysis Q# 70/** ALvI Chemistry/2017/w/TZ 1/ Paper 5/Q# 2/www.SmashingScience.org

2(a)	time /s	burette reading /cm ³	volume (of hydrogen) /cm ³	charge /C	2
	0	46.20	0.00	0	
	50	41.20	5.00	40	
	100	36.20	10.00	80	
	150	31.45	14.75	120	
	200	25.80	20.40	160	
	250	20.80	25.40	200	
	300	16.40	29.80	240	
	350	11.45	34.75	280	
	400	6.80	39.40	320	
	450	1.50	44.70	360	
	volumes of hydrogen correct to 2 d.p. charge correct				
2(b)	All ten points plotted correctly				1
	Best-fit straight line drawn				1
2(c)	Yes, (the data is reliable because) most of the points are on the line OR only a few points are not on the line.				1
2(d)(i)	co-ordinates read and recorded correctly				1
	gradient determined				1
2(d)(ii)	= (i) ÷ 24000				1
2(d)(iii)	= 1 ÷ (2 × (ii))				1

2(e)(i)	<p>straight line from origin to (300, 9.0)</p>	1
2(e)(ii)	Oxygen is (slightly) soluble in water	1
2(f)(i)	<p>straight line with negative gradient</p>	1
2(f)(ii)	Faraday constant will be <u>lower</u> (than calculated) because the volume / V_m larger	1
2(g)	No effect at cathode	1
	Less gas produced at anode	1
	Copper anode will dissolve / is (an) active (anode) OR copper has lower / more negative E^\ominus	1

Topic Chem 24 **Electrolysis Q# 71/** ALVI Chemistry/2018/s/TZ 1/ Paper 5/Q# 1/www.SmashingScience.org

1(a)	Complete circuit with ammeter in series and DC power supply	1
	Anode, cathode and solution labelled	1
1(b)	wear gloves	1
	do not dispose into the water waste / sink OR do not put down drain / sewage OR put in waste bottles	1
1(c)	Mass (of electrode) before and after experiment AND mass unit	1
1(d)	charge = $0.5 \square 30 \square 60 = 900$ C	1
1(e)	$0.282 / 63.5 = 4.44 \square 10^{-3}$ (mol) OR 0.00444	1
1(f)	$(900 / 4.44 \square 10^{-3}) = 202702.7027$ C	1
1(g)	2 moles of electrons are produced / removed / released (so 2 Faradays OR $2 \square 96\ 500$)	1
1(h)	(Faraday) value is smaller AND (apparent) mass / moles / amount is more (for same charge passed)	1
1(i)	CuO is formed / oxidation of copper / carbon / soot is formed	1
1(j)	Some copper falls off the electrode during electrolysis / falls to the bottom of the beaker OR Some copper is lost during washing	1

2(a)(i)	Temperature / thermostatically controlled water bath	1																				
2(a)(ii)	water may evaporate / $[Ag^+]$ will change	1																				
2(b)	<table border="1" style="margin-left: auto; margin-right: auto;"> <thead> <tr> <th>$-\log [Ag^+(aq)]$</th> <th>$16.1E_{cell} / V$</th> </tr> </thead> <tbody> <tr><td>3.00</td><td>-1.56</td></tr> <tr><td>2.30</td><td>-2.25</td></tr> <tr><td>2.00</td><td>-2.56</td></tr> <tr><td>1.60</td><td>-2.75</td></tr> <tr><td>1.30</td><td>-3.25</td></tr> <tr><td>1.00</td><td>-3.56</td></tr> <tr><td>0.70</td><td>-3.85</td></tr> <tr><td>0.30</td><td>-4.25</td></tr> <tr><td>-0.18</td><td>-4.73</td></tr> </tbody> </table> <p>M1 $\log [Ag^+]$ data correct to 2dp M2 $16.1E_{cell}$ data correct to 2dp</p>	$-\log [Ag^+(aq)]$	$16.1E_{cell} / V$	3.00	-1.56	2.30	-2.25	2.00	-2.56	1.60	-2.75	1.30	-3.25	1.00	-3.56	0.70	-3.85	0.30	-4.25	-0.18	-4.73	2
$-\log [Ag^+(aq)]$	$16.1E_{cell} / V$																					
3.00	-1.56																					
2.30	-2.25																					
2.00	-2.56																					
1.60	-2.75																					
1.30	-3.25																					
1.00	-3.56																					
0.70	-3.85																					
0.30	-4.25																					
-0.18	-4.73																					
2(c)(i)	<p>M1 All nine points plotted correctly M2 Best-fit straight line drawn</p>	2																				
2(c)(ii)	<p>M1 Point at (1.60, -2.75) circled</p> <p>M2 Not concentrated enough / more dilute / less than $0.025 \text{ mol dm}^{-3}$</p>	2																				
2(c)(iii)	intercept at $-\log [Ag^+(aq)] = 0$ read and recorded correctly	1																				
2(d)(i)	$12.5 / 12.50 \text{ cm}^3$	1																				
2(d)(ii)	burette	1																				
2(e)(i)	<p>M1 $K_{sp} = (2.82 \times 10^{-5})^2 = 7.95 \times 10^{-10}$</p> <p>M2 3sf</p>	2																				
2(e)(ii)	<p>Temperature labelled on the x-axis and K_{sp} on the y-axis AND (curved) line upwards</p>	1																				
2(f)	<p>M1 Potassium chloride AND / OR sodium chloride</p> <p>M2 Chloride ions would form a precipitate with Ag^+ ions / reduce $[Ag^+]$ concentration</p>	1																				

GENERIC MARKING PRINCIPLE 5:

Marks should be awarded using the full range of marks defined in the mark scheme for the question (however, the use of the full mark range may be limited according to the quality of the candidate responses seen).

GENERIC MARKING PRINCIPLE 6:

Marks awarded are based solely on the requirements as defined in the mark scheme. Marks should not be awarded with grade thresholds or grade descriptors in mind.

1(a)	P = Voltmeter Q = Salt bridge Conc = 1(.00) mol dm ⁻³	1
1(b)(i)	100 / 1000 \square 0.200 = 0.020 moles Volume of 0.500 mol dm ⁻³ = 0.020/0.500 = 40(.0) cm ³	1
1(b)(ii)	M1 Transfer 40.0 cm ³ of 0.500 mol dm ⁻³ solution into a (100.0 cm ³) volumetric flask using a burette	1
	M2 Make up to the <u>mark / line</u> with distilled water. (Stopper and shake).	1

1(b)(iii)					2	
		[Mn ²⁺] / mol dm ⁻³	Cell Potential / V	Log [Mn ²⁺]		Electrode potential (manganese half-cell), E / V
		5.0 \square 10 ⁻¹	+1.529	-0.30		-1.189
		2.0 \square 10 ⁻¹	+1.541	-0.70		-1.201
		1.0 \square 10 ⁻¹	+1.550	-1.00		-1.210
		7.5 \square 10 ⁻²	+1.553	-1.12		-1.213
		2.5 \square 10 ⁻²	+1.567	-1.60		-1.227
		8.0 \square 10 ⁻³	+1.582	-2.10		-1.242
		6.0 \square 10 ⁻³	+1.590	-2.22		-1.250
		4.0 \square 10 ⁻³	+1.591	-2.40		-1.251
		3.0 \square 10 ⁻³	+1.594	-2.52		-1.254
		5.0 \square 10 ⁻⁴	+1.617	-3.30		-1.277
1 mark for each correct column						

1(c)	M1 Correctly plotted data points	1
	M2 Accurate line of best fit	1
1(d)(i)	Ring around point at $-2.22, -1.250$	1
1(d)(ii)	(The point is below the line) The solution is more dilute than it should be.	1
1(e)	-1.18v	1
1(f)(i)	M1 Points read from the graph	1
	M2 Gradient calculated correctly	1
1(f)(ii)	M1 Gradient = $0.059 / z$ $z = 0.059 / \text{gradient}$ $0.059 / 0.0293 = 2.01$	1
	M2 Mn^{2+}	1
1(g)	The equilibrium between the metal and its ions moves to produce more Mn^{2+} or electrons / more reaction $\text{Mn} \rightarrow \text{Mn}^{2+} + 2\text{e}^-$ / the tendency to ionise / oxidise increases.	1

SMASHING!!!

Page 1	Mark Scheme	Syllabus	Paper
	A/AS LEVEL EXAMINATIONS – NOVEMBER 2003	9701	5

N.B. Boxed references within this marking scheme relate to the accompanying booklet of Standing Instructions

Question 1

Experiment 1

Tables 1.1 and 1.2

Give one mark if all weighings are to at least two decimal places, temperatures to at least one decimal place and the subtraction is correct in each table. (1)

Table 1.2 – Accuracy

Calculate $\frac{\text{temperature rise}}{\text{mass of FB2}}$ for the Supervisors values – work to 2 d.p. Record this one the front of the Supervisor's script and as a ringed total below Table 1.2 on each Candidate's script.

Calculate the same ratio for each candidate and calculate the difference to the Supervisor value. Award accuracy marks for differences as follows:

Mark	Difference / °C
4	0.00 to 0.15
3	0.15+ to 0.20
2	0.20+ to 0.30
1	0.30+ to 0.45
0	Greater than 0.45

(4)

- (a) Give one mark for $50 \times 4.3 \times \Delta t$ and appropriate unit (J/kJ)
No mass of sodium carbonate to be included. Ignore sign in (a) (1)
- (b) Give one mark for a calculation showing moles of HCl and moles of sodium carbonate (correct use of 106) and Reference to 2:1 ratio from the equation (1)
- (c) Give one mark for $\frac{\text{answer to (a)}}{\text{correctly calculated moles of Na}_2\text{CO}_3}$ or

$\frac{\text{answer to (a)}}{0.5 \times \text{moles of HCl}}$ if Na₂CO₃ stated to be in excess

and one mark for

an answer correct to 3 significant figures using the numerical values in the expression in (c) (or correct value from (a) and (b) if no working given in (c))
(Do not penalise use of moles of Na₂CO₃ carried in calculator memory from (b))

and sign consistent with experimental results (+ sign required for endothermic reactions)

and unit (J mol⁻¹ or kJ mol⁻¹)

The second mark can be given providing the answer to (a) has been divided by a value for moles of Na₂CO₃ or moles of HCl calculated by the candidate.(2)



Experiment 2

Table 1.3 and 1.4

Give one mark if all weighings are to at least two decimal places, temperatures to at least one decimal place and the subtraction is correct in each table. (1)

Table 1.4 – Accuracy

Calculate $\frac{\text{temperature rise}}{\text{mass of FB3}}$ for the Supervisor's values – work to 2 d.p. Record this on the front of the Supervisor's script and as a ringed total below Table 1.4 on each Candidate's script.

Calculate the same ratio for each candidate and calculate the difference to the Supervisor's value. Award accuracy marks for differences as follows:

Mark	Difference / °C
4	0.00 to 0.11
3	0.10+ to 0.20
2	0.20+ to 0.30
1	0.30+ to 0.50
0	Greater than 0.50

(4)

(d) Give one mark for $50 \times 4.3 \times \Delta t$ and appropriate unit (J/kJ) unless already penalised in (a) Ignore sign in (d) (1)

(e) Give one mark for $\frac{\text{mass of NaHCO}_3}{84}$ Do not penalise a repeat error in calculating M_r e.g. repeated use of an incorrect A_r (1)

(f) Give one mark for $\frac{\text{answer to (d)}}{\text{answer to (e)}}$

and one mark for

an answer correct to 3 significant figures using the numerical values in the expression in (f)

(Do not penalise use of moles of NaHCO_3 carried in calculator memory from (e) and sign consistent with experimental results (+ sign required for endothermic reactions) and unit (J mol^{-1} or kJ^{-1})

Do not penalise if missing mol^{-1} is only error and already penalised in (c)

The second mark can be given providing the answer to (d) has been divided by a value for moles of Na_2CO_3 or moles of HCl . (2)

(g) Give one mark for use of ΔH_1 and $2\Delta H_2$.

Give one mark for $\Delta H_1 - 2\Delta H_2$ in the final part of the calculation

Watch out for sign errors if the candidate has not stated $\Delta H_1 - 2\Delta H_2$ (2)

ASSESSMENT OF PLANNING SKILLS

Look for the following points in any part of the plan or carrying out of the plan and award one mark for each point

- (i) Weighs a sample, adds to known volume of water and measures change in temperature.
- (ii) Calculates energy change for volume of solution used *Numerical answers are required in parts (ii) to (iv).*
- (iii) Converts mass NaHCO_3 into moles.
- (iv) Calculates ΔH_4 including sign (*unless already penalised*).
- (v) Adds 2 ΔH_4 to the answer to (g).
Ignore any reference to ΔH_5 and ΔH_6 etc. by the candidate

Total for Question 1: 25

Question 2

ASSESSMENT OF PLANNING SKILLS

GRID 1A

Adds HCl/ H_2SO_4 or any soluble chloride or soluble sulphate (or KI) to all three solutions	✓	No precipitate formed with FB 5 and with FB 6 (No change or no reaction acceptable)	✓
		White precipitate (yellow with KI) forms with FB 7 Indicated the presence of Pb^{2+}	✓
(Aqueous) ammonia added to the two solutions where no precipitate formed with the first reagent (FB 5 and FB 6) <i>This mark is lost if 2nd reagent is added to all three solutions</i>	✓	FB 5 gives a white precipitate soluble in excess ammonia Indicates the presence of Zn^{2+} FB 6 gives a white precipitate insoluble in excess ammonia Indicates the presence of Al^{3+}	✓

5

GRID 1B

Adds aqueous ammonia to all three solutions	✓	White precipitate formed with all three solutions	✓
		White precipitate formed in FB 5 dissolves in excess ammonia solution. Indicates the presence of Zn^{2+}	✓
Adds HCl/ H_2SO_4 or any soluble chloride or soluble sulphate (or KI) to the two solutions where the precipitate formed with aqueous ammonia did not dissolve in excess of the reagent. <i>This mark is lost if 2nd reagent is added to all three solutions</i>	✓	FB 7 gives a white precipitate (yellow with KI) Indicates the presence of Pb^{2+} There is no precipitate/no change/no reaction with FB 6 Indicates the presence of Al^{3+}	✓

(5)

1 (a) **Weighing Table 1.1**

Give **one** mark if all **three** weighings are to at least 2 decimal places and in the correct places in the Table.

Give **one** mark for a recorded mass of **FB 1** between **2.80 g** and **3.00 g** (both values inclusive)

With-hold one of these marks:

- (i) if there is an error in subtraction which should be correct to number of decimal places shown in the weighing table. (Final zeros may be omitted),
- (ii) the (mass of tube + residual solid) is less than the mass of the empty tube,
- (iii) there is no mass of weighing bottle plus residual zinc

[2]

(b) **Temperature Table**

Give **one** mark if all **recorded** thermometer readings are to at least 1 decimal place (the table does not have to be complete).

With-hold this mark if all recorded temperatures end with .0(0) or .5(0)

[1]

Accuracy marks

On the Supervisor's script:

Ring the temperature at 2½ minutes (2 minutes, 1½ minutes etc if no temperature recorded at 2½ minutes)

Ring the **highest temperature** achieved when recorded for the first time.

Ignore any temperature recorded at 3 minutes – even if this is the highest temperature recorded.

Calculate the difference between the two ringed temperatures.

Record, in a ring, this temperature rise, Δt , to the left of the temperature table on page 4.

Candidate scripts

Ring the temperature at 2½ minutes and the **highest temperature** achieved when recorded for the first time in the same way as for the Supervisor.

(Again ignore any temperature recorded at 3 minutes – even if this is the highest temperature recorded.)

Calculate the difference between the two ringed temperatures. Record this temperature rise, Δt , to the left of the temperature table on page 4.

Calculate the difference between the Supervisor's and candidate's value for Δt .

Award accuracy marks as shown on the next page

The expected temperature rise is about 30 °C. If the Supervisor records a temperature rise that is substantially below this figure award Accuracy marks on the sliding scale shown in the following table:

Mark	Difference to Supervisor / °C	
	Δt about 30 °C	Δt about 15 °C
8	up to 1.00	up to 0.50
7	1.00+ to 1.50	0.50+ to 0.75
6	1.50+ to 2.00	0.75+ to 1.0
5	2.00+ to 2.50	1.0+ to 1.25
4	2.50+ to 3.00	1.25+ to 1.50
3	3.00+ to 5.00	1.50+ to 2.50
2	5.00+ to 7.00	2.50+ to 3.50
1	7.00+ to 10.00	3.50+ to 5.00
0	Greater than 10.00	Greater than 5.00

[8]

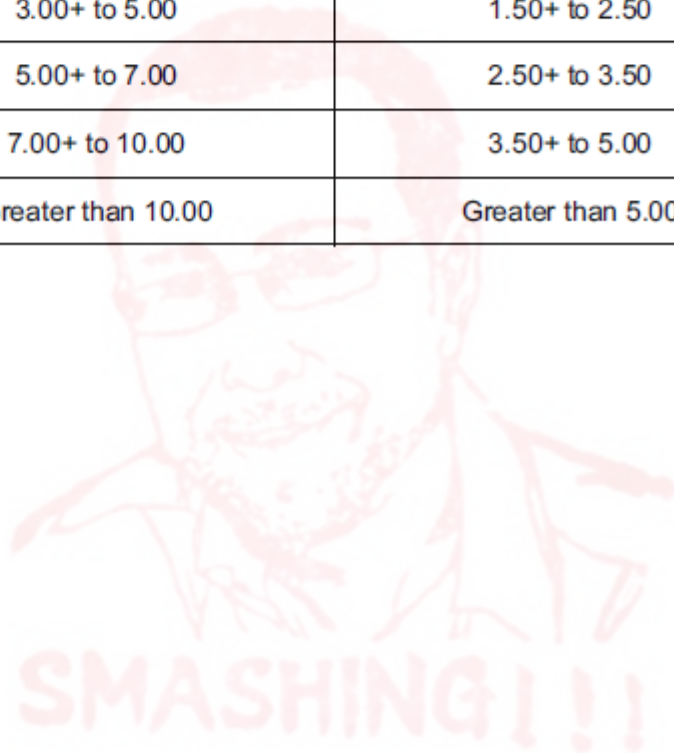

Graph

(d) Plotting of Points.

It is intended that the Examiner will check the plotting of two temperatures on whole numbers of minutes and one at a $\frac{1}{2}$ minute.

Select and indicate, in the temperature table, the following three temperatures:

- i The highest temperature reached, recorded for the first time – the value that has been circled in the temperature table for calculating accuracy marks.

If this initial value falls on a whole number of minutes, select, as the second point to be plotted

- ii The first temperature, lower than the highest temperature recorded in the temperature table

If this second temperature also falls on a whole number of minutes, select as the third point to be plotted

- iii The next lower temperature that falls on a $\frac{1}{2}$ minute

If this initial value falls on a $\frac{1}{2}$ minute, select, as the second point to be plotted

- ii The first temperature, lower than the highest temperature recorded in the temperature table that falls on a whole number of minutes

Select as the third point to be plotted

- iii The next lower temperature that also falls on a whole number of minutes

Check the plotting of these three points

Give **one mark** if all three points have been correctly plotted.

The plotted point must be within $\frac{1}{4}$ small square of the correct position on either axis

If the candidate has not plotted one of the selected points apply similar rules to find the first temperature/plot that can be checked.

*Award **no plotting mark** to a candidate who has plotted no temperatures at $\frac{1}{2}$ minutes.*

*Where a maximum temperature is reached after a considerable time and there is no cooling (remaining temperatures are on a plateau) select the maximum and two appropriate points **before** the maximum is reached (one to be on a $\frac{1}{2}$ minute).*

Give **one mark** if
an approximately horizontal line has been drawn before the addition of zinc powder,

and

a line or curve of "*best fit*", with mainly negative slope, has been drawn after continuous cooling commences

Candidates do not have to link the graphs between 2½ and 3½ minutes.

Give **one mark** if there has been any attempt to extrapolate the cooling curve to 3 minutes.

[3]

- (e) If the extrapolation mark has been given in (d) give **one mark** if the candidate reads from the graph the extrapolated temperature at 3 minutes. This should be correct to half a small square on either axis.

[1]

- (f) Give **one mark** for

$$\frac{\text{mass of zinc}}{65.4}$$

[1]

- (g) Give **one mark** for

$$\frac{25}{1000} \times 0.80 \quad \text{or} \quad 2.0 \times 10^{-2}$$

[1]

- (h) Give **one mark** for

$$25 \times 4.3 \times \text{Temperature rise calculated in (e)} \quad (\text{Ignore any sign})$$

Correct units, J or kJ, necessary.

With-hold this mark if J/..... or kJ/..... is shown at this stage.

[1]

- (i) Give **one mark** for

$$\frac{\text{answer to (h)}}{\text{smaller of answer to (f) or (g)}} \quad (\text{Ignore moles, /mol, mol}^{-1})$$

With-hold this mark if the sign or units are incorrect.

Do not penalise incorrect units, already penalised in (h) [1]

Total for Question 1 = [19]

Skill	Total marks	Breakdown of marks			Question 1	Question 2
		Statement	Marks			
Planning	15 marks	Defining the <u>problem</u>	P	5	5	0
		<u>Methods</u>	M	10	10	0
Analysis, conclusions and evaluation	15 marks	Dealing with <u>data</u>	D	8	0	8
		<u>Evaluation</u>	E	4	0	4
		<u>Conclusion</u>	C	3	0	3

Question	Sections	Statement	Indicative material	Mark
1 (a)	PLAN Problem	P3	CH ₂ identified as structural unit or different number of carbon and hydrogen atoms	1
1 (b)	PLAN Problem	P3	Accept only (a straight line / points in a straight line / bars in a straight line) showing increasing numerical value from C ₁ to C ₅ . <i>Freehand sketches are acceptable</i>	1
1 (c)	PLAN Problem	P1	Independent (Controlled) variable (i) mass/moles of alcohol identified as independent variable. (do not accept amount) (ii) temperature rise or change identified as independent variable. (iii) (alcohol chosen / number of carbon atoms in alcohol / carbon chain length) identified as independent variable or duration of experiment identified as independent variable	1
		P2	Dependent variable (consequential to the Independent variable) (i) (temperature rise or change / heat produced / energy change) identified as dependent variable. (ii) <i>Ignore any reference to ΔH_c</i> (iii) mass/moles of alcohol identified as dependent variable. (do not accept amount) (iv) (temperature rise or change or final temperature / heat produced / energy change) identified as dependent variable or mass/moles of alcohol identified as dependent variable. <i>Ignore any reference to ΔH_c</i>	1

1 (c) contd.	PLAN Problem	P4	Two variables to be controlled selected from: (i) mass or volume of water, (allow amount here) (ii) initial temperature of water or ambient/room temperature (iii) use of same metal can or same position of the burner If alcohol chosen/chain length is chosen as independent variable (iv) mass/moles is controlled	1
1 (d) Part 1	PLAN Methods	M6	1 Uses thermometer capable of reading to 1 °C or better or balance capable of reading to 0.1 g or better.	1
		M1	2 Burns stated or measured mass or moles of ethanol completely, or burns ethanol to get a particular temperature rise, or burns ethanol for a particular length of time.	1
		M2	3 Measures initial and final temperature, or measures initial and final masses of ethanol.	1
		M6	4 Shows how the mass of ethanol is converted to moles. (Items 3 & 4 can be taken from the table or the calculation.) (46 must be shown in an expression – not the symbol M_r)	1
		M5	5 Uses $mc\Delta T$ to calculate heat absorbed by the water in the can. We need to look for either suggested numbers or algebraic symbols (not just $mc\Delta T$. Accept ΔT but not theta unless defined.	1
		M5	6 Scales heat absorbed for 1 mol of ethanol (correct units are needed here)	1
1 (e)	PLAN Methods		Draws up table(s), for range of alcohols, to show the following headings (with correct units, there is no penalty here for representing the units incorrectly but EACH COLUMN in the table needs to have correct units recorded (even if this means several columns with the same unit). Allow K for °C):	
		M9	(i) two weighings + mass of alcohols or two temperature readings + ΔT	1
		M9	(ii) The "other" measured quantity: mass of alcohol used or ΔT .	1
			If the table is for less than all the alcohols apply a penalty of 1 mark	
			Safety mark: If the table only contains the following recordings; initial and final mass and initial and final temperature, give one mark	
			<u>On pages 4 & 5 penalise a unit error only once.</u>	

1 (f)	PLAN Methods	M5	<p>One improvement to reduce heat loss given in diagram and by explanation. From:</p> <ul style="list-style-type: none"> (i) insulation on sides but not bottom of can (ii) lid on can (iii) draught shield fitted (iv) lower tripod or raise burner (v) replacement of tripod with insulated support <p>Each suggestion should be supported by an appropriate reason and for such items as 'move the flame closer to the can' we need to know how this is to be done. Heat lost to the surroundings or atmosphere etc., generates no mark. Heat loss could be through the top of the cup (convection) or through the sides of the can (conduction)</p> <p>Second improvement from same list</p> <p><i>Give one of these two marks for two listed improvements without explanation.</i></p>	1
		M5		1
Qn 1	Total			15



2 (a)	<p>M1 column amount of ethanol burned correctly completed M2 column energy transferred to the water correctly completed</p> <table border="1" data-bbox="552 230 1074 846"> <thead> <tr> <th>experiment number</th> <th>amount of ethanol burned / mol</th> <th>energy transferred to the water /kJ</th> </tr> </thead> <tbody> <tr><td>1</td><td>0.00850</td><td>3.26</td></tr> <tr><td>2</td><td>0.0106</td><td>3.95</td></tr> <tr><td>3</td><td>0.0110</td><td>4.10</td></tr> <tr><td>4</td><td>0.0122</td><td>4.50</td></tr> <tr><td>5</td><td>0.0158</td><td>5.62</td></tr> <tr><td>6</td><td>0.0130</td><td>5.20</td></tr> <tr><td>7</td><td>0.00891</td><td>3.39</td></tr> <tr><td>8</td><td>0.0148</td><td>5.30</td></tr> </tbody> </table>	experiment number	amount of ethanol burned / mol	energy transferred to the water /kJ	1	0.00850	3.26	2	0.0106	3.95	3	0.0110	4.10	4	0.0122	4.50	5	0.0158	5.62	6	0.0130	5.20	7	0.00891	3.39	8	0.0148	5.30	[2]
experiment number	amount of ethanol burned / mol	energy transferred to the water /kJ																											
1	0.00850	3.26																											
2	0.0106	3.95																											
3	0.0110	4.10																											
4	0.0122	4.50																											
5	0.0158	5.62																											
6	0.0130	5.20																											
7	0.00891	3.39																											
8	0.0148	5.30																											
(b)	<p>M1 at least eight correctly plotted points; M2 correct straight line;</p>	[2]																											
(c)	experiment 6;	[1]																											
(d)	<p>M1 co-ordinates, e.g. (0.0106, 3.95) and (0.0158, 5.62); M2 gradient correctly calculated from points, e.g. $321 \text{ (kJ mol}^{-1}\text{)}$;</p>	[2]																											
(e)	because the reaction is exothermic;	[1]																											
(f) (i)	<p>$((2 \times 0.0005) / 0.391) \times 100 = 0.256\%$ and $(0.05 / 40.0) \times 100 = 0.125\%$;</p>	[1]																											
(ii)	<p>(total) errors in weighing do not account for the (large) error in enthalpy change determined; or heat loss (is more significant);</p>	[1]																											

1(a)	diagram of a labelled insulated container containing a liquid	1
	labelled timing device and a labelled thermometer in / touching the liquid	1
1(b)	to ensure temperature of water / experiment / apparatus is at room temperature / constant temperature	1
1(c)	the (anhydrous) calcium chloride is added at this point	1
1(d)	not all the CaCl_2 has dissolved (in the first minute) OR dissolving / reaction was not complete	1
1(e)	the cooling curve has a straight line of best fit that extrapolates to 3.0 minutes (or beyond) AND a straight line connecting all the points from 0–2.5 minutes that extrapolates to 3.0 minutes (or beyond)	1
	theoretical temperature rise to 1dp	1
1(f)	8.5 min	1
	AND not enough time to reach solution temperature OR it takes time for the thermometer to reach equilibrium with the water temperature	
1(g)	ensure uniformity of heating (of solution)	1
1(h)	wear gloves OR wear (face) mask	1
1(i)	$75.0 \times 4.18 \times 30.0 = 9405 \text{ (J)}$ OR 9.405 kJ	1
	(1 mol of $\text{CaCl}_2 = 111.1 \text{ g}$) Mass CaCl_2 required = $\frac{9.405}{82.5} \times 111.1 = 12.7 \text{ g}$	1
Total:		12

Defining the Problem

P1	Identify the apparatus suitable for carrying out each step of the procedure.
P2	Express the aim in terms of a prediction.

Methods

M1	Describe precautions that should be taken to keep risks to a minimum.
M2	Describe the method to be used when carrying out the experiment.
M3	Describe how the data might be used to reach a conclusion
M4	Describe the arrangement of the apparatus
M5	Measuring instruments should be chosen to measure the correct quantity to a suitable precision.

Dealing with data

D1	Use calculations to enable simplification or explanation of data
D2	Use a table or graph to draw attention to the key points in quantitative data.

Evaluation

E1	Identify the extent to which provided readings have been replicated
E2	Suggest and explain the effect that a change in the conditions used for the experiment might have on the results obtained.
E3	Identify and explain the weaknesses of the experimental procedure used.

Conclusion

C1	Draw conclusion from an investigation
C2	Suggest improvements

1(a)(i)	Prediction: Temperature increases AND Electrostatic attraction between the different molecules is stronger electrostatic attractions within each type of molecule.	1
1(a)(ii)	Two equal volumes and a total volume < 25 cm ³	1
	Measure initial temperature of liquids (in measuring cylinders) – leave to equilibrate	1
	Mix two liquids in the beaker, monitor temperature every minute until temp starts to fall / read the maximum temperature	1
1(b)	one of: <ul style="list-style-type: none"> • Use a polystyrene cup instead of the glass beaker / insulate the glass beaker / use a dewar flask • Cover the beaker with a lid • Insulate the glass beaker 	1
1(c)	The experiment must not be performed near any naked flames OR Use an electric heater	1
1(d)	Use a burette / graduated pipette instead of a measuring cylinder OR Use larger volumes of liquids OR Use a more accurate thermometer	1
1(e)(i)	37.50 / 119.5 = 0.314 AND 19.75 / 58 = 0.341	1
1(e)(ii)	M1 Use of limiting factor (0.314) for number of moles M2 $\Delta H = -1.67/0.314 = -5.32 \text{ kJmol}^{-1}$	2
1(f)	keep volume of trichloromethane same and vary volume of propanone and record temperature change	1

Topic Chem 5 **Thermometric Q# 80/** ALvl Chemistry/2021/m/TZ 2/ Paper 5/Q# 1/www.SmashingScience.org

1(a)	1 °C	1
1(b)	M1: diagram of labelled polystyrene cup in a beaker AND containing labelled aqueous copper(II) sulfate M2: diagram of free-standing labelled thermometer with bulb clearly within the solution	2
1(c)	M1: plots after 4 mins and curved line of best fit back from 10 mins to 5 min M1: extrapolation to 4 mins and correct subtraction to determine ΔT	2
1(d)	M1: energy released = $-25.0 \times 4.18 \times \Delta T$ in 1(c) = (-2560.5) J M2: enthalpy change of reaction = $(M1 / 1000) / 1.25 \times 10^{-2} = -205 \text{ (kJ mol}^{-1}\text{)}$	2
1(e)(i)	no change / effect AND zinc is (already) in excess	1
1(e)(ii)	(heat loss) increases AND increased energy output / temperature rise OR more exothermic change occurs	1
1(e)(iii)	no change / effect AND twice the energy output nullified / cancelled out by twice the volume of water to be heated	1

Skill	Total marks	Breakdown of marks		Question 1	Question 2
			Marks		
Planning	15 marks	Defining the <u>problem</u>	5	5	0
		<u>Methods</u>	10	10	0
Analysis, conclusions and evaluation	15 marks	Dealing with <u>data</u>	8	0	8
		<u>Evaluation</u>	4	1	3
		<u>Conclusion</u>	3	0	3

Question	Sections	Indicative material	Mark
1 (a)	PLAN Problem	Use of ion size and ionic charge or charge density to predict decreasing ΔH_{soln} for LiOH to CsOH (Do not give this mark if reference is to size of atom rather than ion)	1
		Correct sketch for <u>candidate predicted trend</u> . Accept any appropriate downward or upward trend. Points alone are sufficient. If no trend is predicted in the first part of (a) the second mark can be given for a downward trend.	1
1 (b)	PLAN Problem	Independent variable accept any of the following; 1. mass/weight/moles/amount of MOH (<i>not metal</i>), 2. "which MOH used", 3. Group I hydroxide.	1
		Dependent variable accept any of the following; 1. temperature rise/change, 2. heat produced/energy change, 3. ΔH_{soln} .	1
		Controlled variable accept either of the following; 1. volume/weight of water, (<i>not amount</i>) 2. mass of hydroxide – <i>only allowed</i> if "which hydroxide" is given as the independent variable.	1

Question	Sections	Indicative material	Mark
1 (c)	PLAN Methods	Apparatus diagram showing (insulated) container and thermometer. <i>Non-insulated beaker is acceptable. (Do not give this mark if there is a Bunsen or a water bath)</i>	1
	ACE Evaluation	Give one mark for any two of the following; 1. solid absorbing water vapour, 2. heat loss from apparatus, <i>(accept open cup/calorimeter)</i> <i>(conduction, convection and radiation are treated as separate errors)</i> 3. loss of material – <i>solution overflows or spray,</i> 4. inaccurate temperature measurement, 5. small temperature rise. <i>Do not give this mark for reference to laboratory temperature or draughts in the laboratory.</i>	1
	PLAN Methods	Give one mark for any two of the following - <u>if linked to the source of error above</u> ; 1. keep weighed solid in closed container or use as soon as weighed <i>(not kept under oil or in a vacuum)</i> 2. practical improvement to insulation, 3. larger container or smaller quantities used, <i>(accept use of lid for minimising spray)</i> 4. more accurately <u>calibrated</u> thermometer, 5. use larger mass of the hydroxide or smaller volume of water. <i>(Give one of these two marks for one error and step to minimise the error)</i>	1
1 (d)	PLAN Methods	Identify the corrosive nature of the solid/aqueous hydroxides.	1
		If corrosive is identified as the hazard give this mark for using gloves or	1
		If solution boils over or sprays out but is not described as corrosive give this mark for using two of gloves, lab coat, eye protection, (face) mask	

1 (e)	PLAN Methods	<p>1. weighs a <u>stated mass</u> of <u>named hydroxide</u>. mass to be between 0.05 mol and 0.25 mol (See appendix) and candidate describes the weighing of the solid (<i>two possible methods</i>) (i) empty bottle/empty (plastic) cup; and bottle + solid/(plastic) cup + solid (ii) bottle + solid and bottle + residual solid</p> <p>2. measures between 50 cm³ and 200 cm³ of water and describes the measurement of the volume (measuring cylinder, burette, pipette) (<i>apparatus for measuring the water and the volume used may be shown in the diagram</i>) (<i>A larger or smaller volume of water can be accepted if it is related to a specified capacity container.</i> <i>e.g. 400 cm³ water in 500 cm³ beaker 30 cm³ water in 50 cm³ beaker</i>)</p> <p>3. Initial and <u>highest</u> temperatures recorded</p> <p>4. Step by step procedure described Minimum steps required: Weigh solid, specified/measured volume of water and measured temperature rise</p>	<p>1</p> <p>1</p> <p>1</p> <p>1</p>
1 (f)	PLAN Methods	<p>Table showing metal hydroxides two weighings - unless tare specified, initial and final temperatures. Ignore units. <i>Do not give this mark if candidate lists metals for the experiment rather than the metal hydroxides unless the column is headed "metal hydroxide" / "hydroxide"</i> <i>or</i> <i>metals have been penalised in (e).</i></p> <p><i>If weighings are missing in (e) the mark can be given in (f) if the mass of metal hydroxide is tabulated.</i> <i>If temperature readings are missing in (e) the mark can be given in (f) if ΔT is tabulated.</i></p>	1

1 (g)	PLAN Methods	Shows how enthalpy change of solution is calculated for one hydroxide using $\frac{mc\Delta T}{\text{moles}}$ <i>Be certain that m refers to liquid and not solid or liquid + solid</i> To gain this mark there must be an expression for converting mass of metal hydroxide to moles, including the correct numerical value for the appropriate M_r . <i>This calculation or numerical evidence for M_r may be found in earlier work – (e) or (f)</i>	1
Question 1 Total			16

Question 1 (e)

metal hydroxide	M_r	mass of metal hydroxide / g				
		0.05 mol	0.10 mol	0.15 mol	0.20 mol	0.25 mol
LiOH	23.9	1.195	2.39	3.585	4.78	5.975
NaOH	40.0	2.00	4.00	6.00	8.00	10.00
KOH	56.1	2.805	5.61	8.415	11.22	14.025
RbOH	102.5	5.125	10.25	15.375	20.50	25.625
CsOH	150.0	7.50	15.00	22.50	30.00	37.50

Topic Chem 23 **Thermometric Q# 82/** ALvI Chemistry/2011/w/TZ 1/ Paper 5/Q# 1/www.SmashingScience.org

1 (a)	PLAN Problem	Predicts that the solubility increases (with temperature). If gave "decreasing" then ecf into sketch and do not mark explanation. [1]
		KNO ₃ needs energy to dissolve OR supplying heat or energy or increasing temperature will promote the endothermic change/ reaction. [1]
		Any graph showing an increasing solubility with temperature (curve or straight line) that reflects the prediction. Do not accept a concave curve that becomes vertical. Accept a convex curve (accept with a max or an end decline). There can be a plateau in solubility. Have solubility on the y axis and temperature on the x axis. Ignore units unless the unit is the label. If gave "decreasing" above then can mark sketch as stand alone [1]
(b)	PLAN Problem	(i) Temperature as the independent variable. [1]
		(ii) Solubility as the dependent variable. Has to be a double quantity, not just mass or amount of solute. [1] Ecf "concentration" if given as y-axis in sketch.

(c)	PLAN Methods	<p>There are four different approaches, all of which share the first five marking points.</p> <p>Use 7 number labelled ticks and crosses for these points.</p> <p>(i) At least 5 experiments. [1]</p> <p>(ii) Uses a range of at least 40°C. [1]</p> <p>(iii) Pilot run to choose relative amounts of materials. [1]</p> <p>(iv) Mass by balance. Water by measuring cylinder/pipette/ burette or mass of water by balance. [1]</p> <p>(v) stirs [1]</p> <p>Alternate 1</p> <p>(vi) Heat mixture to dissolve all the solute. [1]</p> <p>(vii) Cool and measure the temperature at which first crystals appear. [1]</p> <p>OR Alternate 2</p> <p>(vi) Heats mixture to a particular temperature.</p> <p>(vii) Filters the solution (not cooled or decanted) and weighs the residue.</p> <p>OR Alternate 3</p> <p>(vi) Heats mixture to a particular temperature.</p> <p>(vii) filters the solution (not cooled or decanted) and evaporates the filtrate and weighs solid.</p> <p>OR Alternate 4</p> <p>(vi) Heats mixture to dissolve the solute.</p> <p>(vii) Records temperature at which the solute dissolves.</p>	
(d)	PLAN Methods	<p>Reference to 'hot' apparatus, not Bunsen or water with</p> <p>Handle with tongs/heat resistant gloves/cool before handling</p>	[1]

(e)	PLAN Methods	1(c)(i) & (ii) could award here. Mass of solid dissolved; volume/mass of water; solubility; temperature (solution) and units. Only accept a final temperature if it relates to the temperature of solution. All five correct 2 marks; Three or four correct (one/two errors) 1 mark; Two or less correct (more than two errors) zero.	[2]
	Total		[15]

Topic Chem 23 **Thermometric Q# 83**/ ALvl Chemistry/2013/w/TZ 1/ Paper 5/Q# 1/www.SmashingScience.org

1 (a) (i)	(The temperature would) decrease The lattice enthalpy is more negative/exothermic than the (sum of the) enthalpies/energies of hydration.	1 1
(ii)	<p>OR</p> <p>OR ecf from 1(a)(i)</p>	2

(b) (i)	concentration/concentration change	
(ii)	temperature change/decrease in temperature (allow ecf on (a)(i))	1
(c)	Diagram shows a container labelled with its capacity (between 25 cm ³ and 250 cm ³) and with the thermometer in a solution.	1
	The apparatus is insulated and has a lid.	1
	Thermometer range must include 25 °C and with a precision of between 0.1°C and 0.5°C.	1
(d)	A minimum of 5 workable experiments using masses or concentrations.	1
	Measures initial and final temperatures.	1
	Measures a volume of water AND the volume of water will fit into container labelled in (c).	1
	States a mass which is the maximum for a volume of water stated.	1
(e)	Ammonium nitrate may cause a fire/explosion so must not be ground up OR dilute to less than 0.5 mol dm ⁻³ before disposal.	1
(f)	Columns must include units: Mass of ammonium nitrate used / any mass unit Volume / mass of water used / any volume or mass units Initial temperature / °C Final temperature / °C Temperature fall / change in temperature / °C Concentration of ammonium nitrate / any concentration units	
	Four columns correct Five or six columns correct	1 1
		[Total: 15]

SMASHING!!!

1(a)	It is not possible to measure a temperature when heating.	1
1(b)(i)	Mass of $\text{KHCO}_3 = 2.503 \text{ g}$ AND Mass of $\text{K}_2\text{CO}_3 = 3.455 \text{ g}$	1
1(b)(ii)	$= \frac{2 \times 0.0005 \times 100}{2.503} = 0.04(00)\%$ Correct working must be shown	1
1(c)(i)	M1 3.5°C for KHCO_3 and 1.5°C for K_2CO_3 in results table AND $q = 50 \times 4.18 \times 3.5 = 731.5 \text{ (J)}$ M2 $\Delta H_1 = \text{M1} / (0.0250 \times 1000) = + 29.26 \text{ kJ mol}^{-1}$	2
1(c)(ii)	M1 $q = \text{K}_2\text{CO}_3 = 50 \times 4.18 \times 1.5 = 313.5 \text{ (J)}$ M2 $\Delta H_2 = -\frac{\text{M1}}{0.025 \times 1000} = -12.54 \text{ kJ mol}^{-1}$	2
1(d)	M1 $2 \times 1(c)(i) = 2 \times 29.26 = 58.52 \text{ kJ mol}^{-1}$ M2 $\text{M1} - 1(c)(ii) = +58.52 - (-12.54) = +71.06 \text{ kJ mol}^{-1}$	2
1(e)	Any two from: <ul style="list-style-type: none"> Heat loss OR heat gain (to / from surroundings) Amount of solid not exactly 0.0250 moles Experiment not carried out under standard conditions. 	2
1(f)	Add a lid to the polystyrene cup.	1
1(g)	Burette.	1
1(h)	Wear chemically resistant gloves AND Reagent(s) are irritant(s).	1

Miscellaneous MS

2(a)(i)	points plotted correctly from table	1
	line through origin	1
2(a)(ii)	point at 0.045 g cm^{-3}	1
2(a)(iii)	two sets of coordinates shown.	1
	gradient correctly calculated expected value = $66-67(^\circ)$ value must be to 2 dp	1
2(b)(i)	$0.0750 \times 250 = 18.75 \text{ (g)}$	1
2(b)(ii)	dissolve the sucrose / mass of sucrose given in 2(b)(i) / weighed mass in a stated volume of (distilled) water, less than 250 cm^3 , or if not stated but then later made up to 250 cm^3 / up to the mark	1
	transfer solution to (a 250 cm^3) volumetric flask AND Make up the solution to the mark / flask volume with (distilled) water	1

2(c)(i)	$\left(\frac{0.0350}{0.0750} \times 15.00 = 7.00 \text{ cm}^3\right)$ Volume of standard solution = 7.00 (cm ³) Volume of distilled water = 8.00 (cm ³)	1
2(c)(ii)	burette / graduated pipette	1
2(c)(iii)	solution was more dilute than expected	1
2(d)	3.75 correctly read off graph (0.056–0.057)(g cm ⁻³) or correctly calculated from 3.75 = 2(a)(iii) × concentration	1
	conc of sucrose = (56–57)(g dm ⁻³) or multiplying a concentration by 1000 correctly	1
	conc of sucrose = (0.164–0.167)(mol dm ⁻³) or dividing a concentration by M _r / (342) correctly	1
2(e)	wash out with small volume of solution of concentration to be used	1
2(f)	predicted value: (+)10.10 / 10.1 or twice value at 0.075 taken from graph	1
	explanation: (The plane polarised light encounters) more (twice) molecules / moles / amount of sucrose	1
2(g)	To calibrate the instrument / to set the polarimeter to 0 degrees	1
	Total:	18

Topic Chem 28 **Miscellaneous Q# 88/** ALVI Chemistry/2017/m/TZ 2/ Paper 5/Q# 2/www.SmashingScience.org

2(a)(i)	M1 mol of Fe(NO ₃) ₃ ·9H ₂ O needed = 0.05 × 100/1000 = 0.005(00) mol	1
	M2 0.0005 × 403.8 = 2.02 g	1
2(a)(ii)	M1 <i>dissolving of solid / making of a solution</i> dissolve (2.02 g / answer to 2(a)(i) of) hydrated salt in (a container with) distilled water / less than 100 cm ³ of water	1
	M2 <i>making it into a standard solution</i> (transfer / add to) a (100 cm ³) volumetric flask; make to mark (with (distilled) water) (and shake)	1
2(b)(i)	M1 all points plotted	1
	M2 two lines which are extrapolated to meet	1
2(b)(ii)	correct reading of volume of Fe ³⁺ and volume of 2-hydroxybenzoate ions from graph combined to make 10.0 cm ³ (expected values: Fe ³⁺ = 3.3 cm ³ ; 2-hydroxybenzoate = 6.7 cm ³)	1
2(b)(iii)	2	1
2(b)(iv)	[Fe(H ₂ O) ₂ (HO–C ₆ H ₄ –CO ₂) ₂] ⁺	1
2(b)(v)	burette(s)	1
2(c)	23±1%	1
2(d)	dm ³ cm ⁻¹ mol ⁻¹	1

2 Assessment of Planning Skills**Numbered sequence and Table of Results**

Give **one mark** for each of the following points.

They may be found in the text on page 4 or in the table of results on page 5.

Record the **letter** of the point being awarded close to the scoring point in the script and tick, ✓, the box in the margin to show the particular point has been considered.

- a weighing a suitable container – **only one of the following** test-tube, boiling-tube, crucible, evaporating dish/basin
- b weighing container + sample - **Not weighing solid alone or into the container**
- c heating and re-weighing after heating
- d any evidence of re-heating and weighing again
- e (heating) to constant mass (stated or described)

5

Give **one mark** for each of the following points.

They may be found in the text on page 4 or in the table of results on page 5.

- f calculating the mass of water lost in the experiment
- g calculating moles of water/anhydrous sodium carbonate using 18/106 correctly
- h calculating moles of water per mole of anhydrous sodium carbonate

i % water lost on standing = $\frac{(10 - \text{moles of water in (h)})}{10} \times 100$

or = $100 - \left(\frac{\text{moles of water in (h)}}{10} \times 100 \right)$

OR

- f calculating the mass of water lost in the experiment
- g calculating the mass of $\text{Na}_2\text{CO}_3 \cdot 10\text{H}_2\text{O}$ that would give the mass of anhydrous solid left at the end of the experiment.

$$(\text{mass of } \text{Na}_2\text{CO}_3 \cdot 10\text{H}_2\text{O} = \text{mass of anhydrous } \text{Na}_2\text{CO}_3 \times \frac{286}{106})$$

- h Calculating the mass of water in the mass of $\text{Na}_2\text{CO}_3 \cdot 10\text{H}_2\text{O}$ calculated in (g).
(mass in (g) - mass of anhydrous sodium carbonate)

i % water lost on standing = $\frac{\text{mass of water in (h)} - \text{mass of water lost in (f)}}{\text{mass of water calculated in (h)}} \times 100$

OR



- f calculating the mass of water lost in the experiment
- g Calculating, from practical results, the % of water in $\text{Na}_2\text{CO}_3 \cdot x\text{H}_2\text{O}$ and calculating, from formula, the % of water in $\text{Na}_2\text{CO}_3 \cdot 10\text{H}_2\text{O}$.
- h Calculating moles of water per mole of anhydrous sodium carbonate
- $$\left(\frac{\frac{\% \text{ water}}{18}}{\frac{\% \text{ anhydrous sodium carbonate}}{106}} \right) \text{ for } \text{Na}_2\text{CO}_3 \cdot x\text{H}_2\text{O}.$$
- i % water lost on standing = $\frac{(10 - \text{moles in (h)})}{10} \times 100$

OR

- f calculating the mass of water lost in the experiment
- g Calculating the moles of anhydrous Na_2CO_3 remaining. $\left(\frac{\text{mass of } \text{Na}_2\text{CO}_3}{106} \right)$ and
- $$M_r \text{ for } \text{Na}_2\text{CO}_3 \cdot x\text{H}_2\text{O} = \left(\frac{\text{mass of } \text{Na}_2\text{CO}_3 \cdot x\text{H}_2\text{O}}{\text{moles of anhydrous } \text{Na}_2\text{CO}_3} \right)$$
- h Moles of water lost = $\left(\frac{286 - M_r \text{ calculated in (g)}}{18} \right)$
- i % water lost on standing = $\frac{(\text{moles of water in (h)})}{10} \times 100$

Other variations of the calculation may be encountered – try to fit the method to the steps in (g), (h), (i) above.

4

Total for Question 2 is 9

Total for Paper 30.

Turn over for Examples

In all these calculations assume that 10.0g of $\text{Na}_2\text{CO}_3 \cdot x\text{H}_2\text{O}$ is heated and produces 5.0g of anhydrous Na_2CO_3 .

Method 1

$$\frac{5.0}{106.0} = 0.0472 \text{ moles of anhydrous sodium carbonate, } \frac{5.00}{18.0} = 0.2778 \text{ moles of water}$$

$$\frac{0.2778}{0.0472} = 5.89 \text{ moles of water / mole of sodium carbonate}$$

$$\% \text{ water lost on standing} = \frac{10 - 5.89}{10} \times 100 = 41.1\%$$

Method 2

5.0 g of Na_2CO_3 left after heating

$$\text{This came from } \frac{286}{106} \times 5.0 = 13.49 \text{ g of } \text{Na}_2\text{CO}_3 \cdot 10\text{H}_2\text{O}$$

$$\text{Mass of water} = (13.49 - 5.0) = 8.49 \text{ g}$$

$$\% \text{ water lost on standing} = \frac{(8.49 - 5.00)}{8.49} \times 100 = 41.11\%$$

Method 3

$$\% \text{ water in } \text{Na}_2\text{CO}_3 \cdot x\text{H}_2\text{O} = \frac{5.0}{10.0} = 50\%$$

$$\% \text{ water in } \text{Na}_2\text{CO}_3 \cdot 10\text{H}_2\text{O} = \frac{180.0}{286.0} = 62.9\%$$

Moles of water/mole of sodium carbonate

$$\text{In } \text{Na}_2\text{CO}_3 \cdot x\text{H}_2\text{O} = \frac{\frac{50}{18}}{\frac{50}{106}} = 5.89$$

$$\% \text{ Water lost on standing} = \frac{(10 - 5.89)}{10} \times 100 = 41.1\%$$

Method 4

$$\text{Moles of } \text{Na}_2\text{CO}_3 \text{ and hence } \text{Na}_2\text{CO}_3 \cdot x\text{H}_2\text{O} = \frac{5.0}{106} = 0.0472 \text{ moles}$$

$$M_r \text{ of } \text{Na}_2\text{CO}_3 \cdot x\text{H}_2\text{O} = \frac{10.0}{0.0472} = 212$$

$$\text{Moles of water lost on standing} = \frac{286 - 212}{18} = 4.11 \text{ moles}$$

$$\% \text{ of water lost on standing} = \frac{4.11}{10} \times 100 = 41.1\%$$



ASSESSMENT OF PLANNING SKILLS

Plan

Give one mark for each of the following points.

Identify the method below that gives the best match - there may be cross-over.

(Record the letter of the point awarded in the text where given and tick the appropriate box in the margin)

Method	A Heat/Mass	B Heat/ Volume	C Acid/ Volume	D Acid/ Mass	E CuCO ₃ Back- Titre	F CO ₂ Back- Titre	G CuO Back- Titre	H Residue method	I CuCO ₃ / CuO Titration
a	Weighs sample	Weighs sample	Weighs sample	Weighs sample and acid	Weighs sample	Weighs sample	Weighs sample	Weighs sample	Weighs sample
b	Heat	Heat	Placed in acid	Placed in acid	Known moles of acid measured	CO ₂ produced in suitable way	CO ₂ produced	Adds excess acid	Makes solution in a volumetric flask
c	Reweigh	CO ₂ collected	CO ₂ collected	Reweigh	CuCO ₃ dissolved in excess acid	CO ₂ dissolved in excess alkali	CuO dissolved in excess acid	Filter/dry residue	Titrate with standard acid
d	Heat to constant mass	Volume of gas measured	Volume of gas measured	Mass of CO ₂ calculated	Excess of acid titrated	Excess of alkali titrated	Excess of acid titrated	Weighs residue	

4



Table of Results

Give three marks if table(s) show all measurements necessary

Deduct one mark for each measurement missing. (No negative marks)

The candidate must give all necessary readings: each relevant unit must be seen at least once.

Examiners must be satisfied that all practical readings needed for the candidate's method have been recorded.

Weighings must include:

Mass of empty container

Mass of container + solid

(Mass of container + residual solid) where appropriate etc.

Collection of gas must include:

An initial volume of gas

A final volume of gas

Titration results must include:

Initial burette readings

Final burette readings

Titre volume

3

Processing of Results

Give one mark for each of the following points. (Tick the appropriate box in the margin)

Mathematical expressions (using algebra or specimen values) must be included in the processing of results. Use must be made of the A_r values given in the paper and the GMV where appropriate.

Method	Mass/Volume methods	Back-Titre methods	Residue methods	CuCO ₃ /CuO titre
e	Volume of mass of CO ₂ converted to moles	Initial moles of acid/alkali – excess moles of acid/alkali gives moles of CO ₂ /CuO/CuCO ₃	Find mass of CuCO ₃ by subtraction	Moles of acid converted to moles of CuCO ₃
f	Moles of CO ₂ converted to moles and mass of CuCO ₃	Moles converted to mass of CuCO ₃	% of CuCO ₃ calculated	Moles of CuCO ₃ converted to mass of CuCO ₃
g	% of CuCO ₃ calculated	% of CuCO ₃ calculated		% of CuCO ₃ calculated

Plan Marks

Marks for the Plan (a-d) may be awarded from the Table(s) of Results or from the Processing of Results

Processing of Results Marks

Marks in the final section (e-g) may be found in and awarded from the Planning Section

Marks for the Table of Results

The three marks in this section can only be awarded in the Table of Results Section

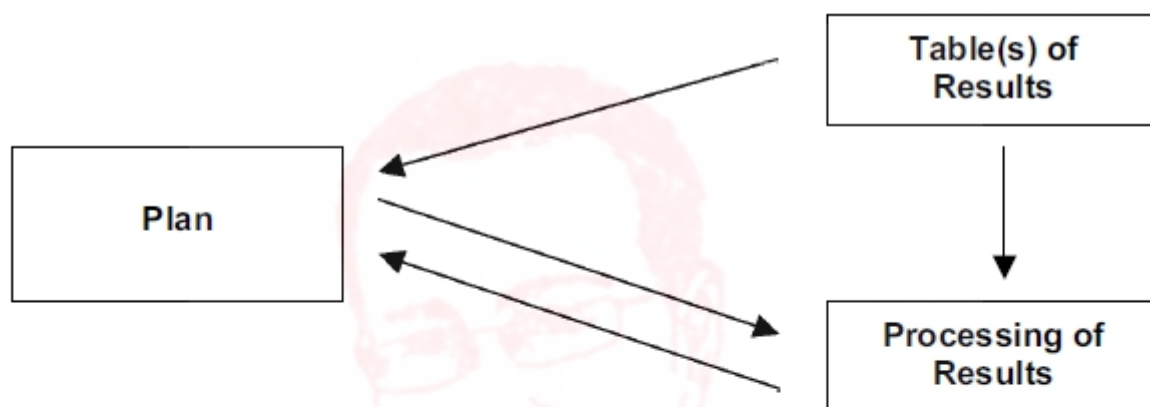

Total for Question 2

10

Total for Paper

30

- 1 (b) Check, and correct if necessary, the mass of **FB 2** used.
Give one mark if the mass has been correctly calculated. [1]

If either weighing in Table 1.1 is not recorded to 2 decimal places or better deduct one mark from the accuracy mark below.

- (c) Check, and correct if necessary, the mass of carbon dioxide evolved.
(mass of flask + acid) + mass of **FB 2** - (mass of flask + solution after reaction)
Give one mark if the mass has been correctly calculated. [1]

ACCURACY - CANDIDATE SCRIPTS

Calculate the ratio $\frac{\text{mass of FB 2}}{\text{mass of carbon dioxide}}$ correct to 2 decimal places.

Record the candidate's ratio and the Supervisor's ratio, ringed, below Table 1.1.

Calculate the difference between the Supervisor's ratio and the candidate's ratio.
Award accuracy marks as follows:

Mark	Difference
3	Up to 0.10
2	0.10+ to 0.20
1	0.20+ to 0.50
0	Greater than 0.50

[3]

The theoretical ratio is 2.41 but some CO₂ dissolves in the acid so values between 2.65 and 2.70 are more likely to be recorded.

If a very large mass of carbon dioxide is recorded, check the 'hundreds' digit in the masses recorded and correct any error to provide an accuracy mark.

- (d) Give one mark for $\frac{\text{candidate's mass of carbon dioxide}}{44}$ [1]
- (e) Give one mark for $\frac{\text{candidate's mass of FB 2}}{\text{answer to (d)}}$ [1]
- (f) Give one mark for $\frac{[\text{answer to (e)} - 60]}{2}$ [1]

Do NOT give the mark in (f) if a unit has been given in the final answer to (e) or (f).
Ignore reference to atomic mass units/amu.

[Total: 8]



Question	Sections	Statement	Indicative material	Mark
2 (a)	ACE Data	D1	Labels all additional columns used, including units (e.g. /g or (g)) and an appropriate equation: the mass of basic copper(II) carbonate (B–A) the mass of copper(II) oxide (C–A) the mass lost in the expt (B–C) (or from additional columns)	1
		D2	Correct subtractions for columns containing plotted data. (ignore any columns which list the number of moles) See appendix 1 (Allow 2 errors) <i>All values must be correct to 2 decimal places</i>	1
2 (b)	ACE Data	D3	Plots any two of mass/moles of copper(II) oxide; mass of basic copper(II) carbonate; mass lost in the experiment with correct labels and units. (If unit error is the same as in 2(a) do not penalise again) (<i>Accept equations as acceptable labels</i>)	1
		D3	Suitable scales selected – data to be plotted over more than half of each axis	1
		D3	All 10 points plotted and a straight-line passing through the origin and close to the majority of points.	1
2 (c)	ACE Evaluation	E1	Identifies the most significant anomalous point and its coordinates from the graph drawn by the candidate not from the table. <i>If points have been plotted correctly the point identified should be for student 3: 2.22 g carbonate / 1.13 g (0.0142 mol) CuO / 1.09 g mass loss, otherwise the most anomalous point is the one furthest from the graph in a perpendicular direction</i>	1
		E2	Suggests an appropriate reason for the anomalous point. See Appendix 2 (i) if lower than expected mass of CuO, (<i>higher than expected plotted loss of mass</i>) Solid blown out of tube (by not heating gently) Do not allow this mark for spillage. (ii) if higher than expected mass of CuO, (lower than expected plotted loss of mass) Incomplete decomposition	1

2 (d)	ACE Evaluation	E2	Mark consequentially – see Appendix 2 If points have been correctly plotted they should indicate (<i>insufficient loss in mass or mass of copper oxide too high</i>) caused by incomplete decomposition	1
2 (e)	ACE Conclusions	C3	Mark consequentially – see Appendix 2 (this may involve a simple ecf from (d)) (i) For a mass of copper oxide that is too high - refers to heating to constant mass (allow any practical technique which would yield constant mass if carried out e.g. more heat; spreading out the solid; heat for a longer time etc.) (ii) For a mass of copper oxide that is too low - refers to heating more gently	1
2 (f)	ACE Data	D3	Construction (lines) on graph and values read from the graph (with units)	1
		D2	Two of the following expressions used in a calculation: (221 + 18x); 44 + 18(x + 1); 159 (or 2 x 79.5)	1
		D2	The value of x correctly evaluated <i>The expected value of x is approximately 0.5</i>	1
2 (g)	ACE Conclusions	C1	Refers to one of the following as supporting evidence: straight line, line through origin, few points off the line, Any reference to direct proportionality. If the plotting is so poor that a reverse comment might be appropriate here do not reward	1
2 (h)	ACE Conclusions	C3	Realises that (i) CO ₂ gas or CO ₂ and gaseous H ₂ O could be (collected) and its volume (measured) (not amount) (ii) H ₂ O can be condensed and weighed, (iii) CO ₂ and/or H ₂ O can be absorbed and weighed	1
2 (i)	ACE Evaluation	E5	Candidate refers to or calculates a reduction in the % error if using a balance weighing to 3 dp.	1
Qn 2	Total			15

Qn 2 (b)

student	mass of empty boiling-tube / g	mass of boiling-tube and basic carbonate before heating / g	mass of boiling-tube and residue after heating / g	mass of basic carbonate before heating / g	mass of residue / g	mass of material lost on heating / g
1	10.32	11.19	10.92	0.87	<u>0.60</u>	0.27
2	10.05	11.56	11.09	1.51	1.04	0.47
3	10.11	12.33	11.24	2.22	1.13	1.09
4	9.94	12.39	11.62	2.45	1.68	0.77
5	9.99	13.73	12.56	3.74	2.57	1.17
6	10.23	14.68	13.28	4.45	3.05	<u>1.40</u>
7	10.01	15.19	13.56	5.18	3.55	1.63
8	9.87	15.80	13.97	5.93	<u>4.10</u>	1.83
9	9.96	16.62	14.66	6.66	<u>4.70</u>	1.96
10	9.84	17.83	15.46	7.99	5.62	2.37

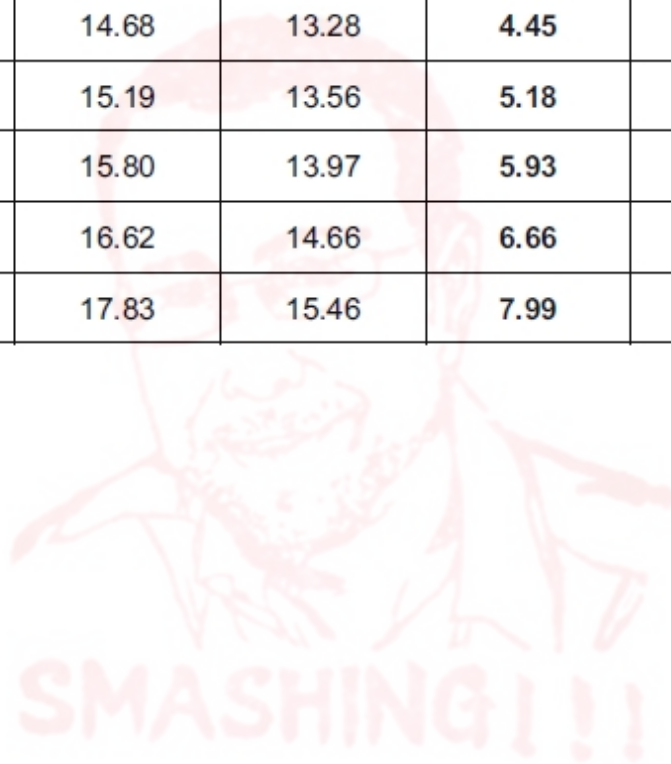

x represents copper oxide/residue blown out of the tube

* represents insufficient decomposition

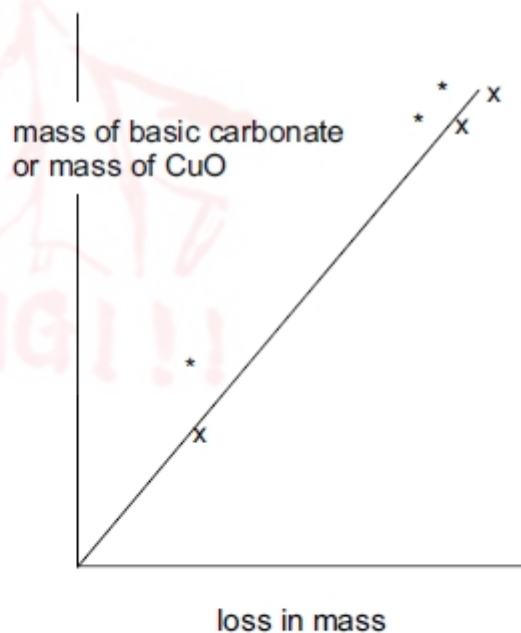
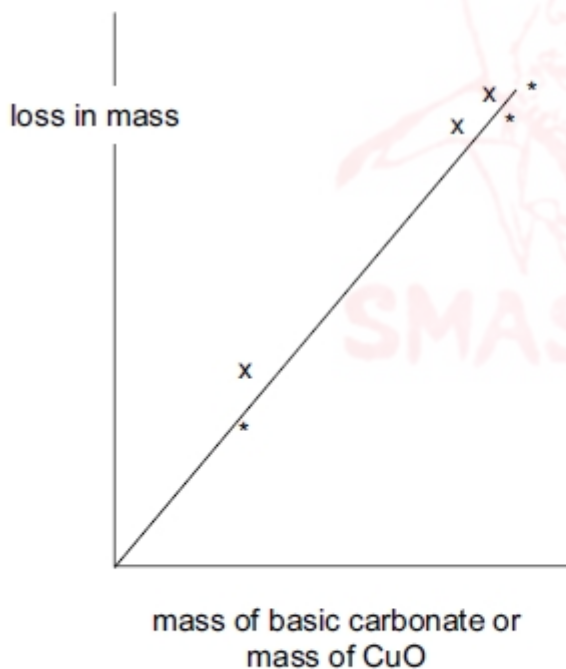
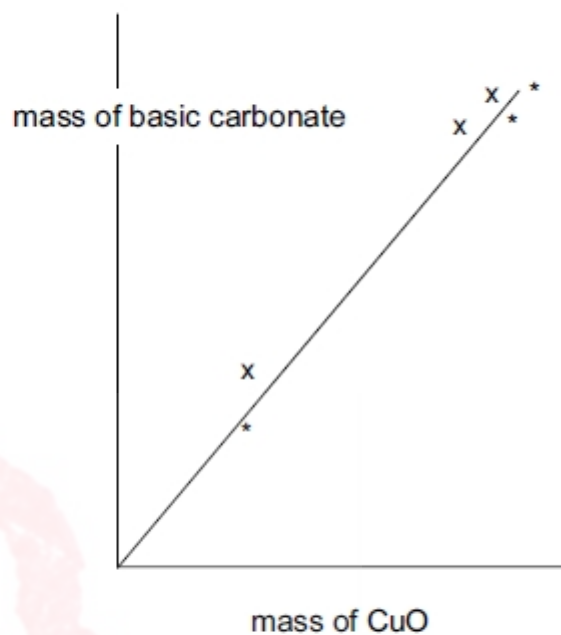
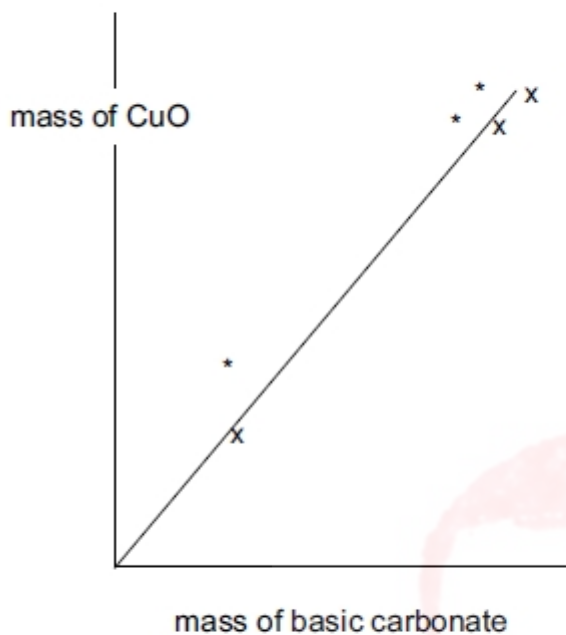

If labelled axes are reversed, points will be on the opposite side of the line drawn.



2 (a)	ACE Data	Mass of zinc <u>used</u> , B-D, / g and full column.	[1]
		Mass of iodine, C-B, / g and full column.	[1]
		Check first 3 subtractions correct in the column labelled iodine. These must also be to 2dp. All 3 must be totally correct. ECF incorrect equation in calculation only.	[1]
(b)	ACE Data ACE Data	Correctly converts the first three masses of zinc to moles of zinc. (to 2 s.f.)	[1]
		Correctly converts the first three masses of iodine to moles of iodine. (to 2 s.f.)	[1]
		For these two marks, allow ecf from incorrect masses in (a). This ecf refers to the masses the candidate believes to be Zn and/or I. (Allow 1 computational/s.f error for the first 3 values in each column.) So 1 error is allowed in these 6 values. If an incorrect A, has been used to calculate moles in all 3 values in one column then count this as just 1 computational error, not 3. For example 254 being used for iodine. A similar error in the Zn column would also count as 1 error only.	[1]
		Has calculated the ratio of I:Zn (to 2 dp.) (do not allow the inverse) (this can be done by simple visual checking) (e.g. 2.08 or 2.08:1). No ecf for calculations that have used < 2 sf in moles.	[1]
		Experiments 3 and 8 calculations correct (to 2 dp.) No ecf for calculations that have used < 2sf in moles In the 3 rd and 4 th marks ecf can operate in the ratio calculation from incorrect values of moles but 2 dp required. If the calculations are evaluated to more than 2 s.f. they should approximate to the 2. s.f. answers. If a value is quoted to 3 sf then allow +/- 1 in the 3 rd figure.	[1]
(c)	ACE Evaluation	Both experiments 3 and 8 only. (other values are neutral if they are there as a consequence of errors in (b) or (a).) These must have some numerical justification in (b).	[1]
(d)	ACE Evaluation ACE Data	Suggests taking an average / plotting a graph.	[1]
		Leaving out the anomalies (when calculating an average) / calculate the gradient/measure the slope.	[1]
(e)	ACE Evaluation	(If experimental ratio of I: Zn is too high (Expt 3)) zinc has been oxidised during drying/ zinc not dried enough/ reaction is incomplete/ not all ZnI ₂ washed away.	[1]
		If experimental ratio of I: Zn is too low (Expt 8) zinc has been blown out of the tube; or Zn lost on pouring out liquid. The reasoning must relate clearly to the correct anomaly. Allow correct reason for an anomaly (other than 3 or 8) stated in (c) provided evidenced in data in (b).	[1]

(f)	ACE Conclusions	Must refer in some way to the general agreement of the calculated/stated ratio being approximately 2 or 1:2 (in (b) or (d)). May have something written below the table in (b). OR The slope of the graph is approximately 2. OR The moles/atoms/ions of iodine is about double that of zinc. Not references to molecules/mass/weight/I ₂	[1]
(g)	ACE Conclusions	Identifies a single point of weakness in method. Possibly: Small masses weighed / large % error in mass. Not if large % error is related to balance dp or accuracy.	[1]
(h)	ACE Conclusion	Suggests titration of iodine with (sodium) thiosulfate.	[1]
Qn 2	Total		[15]

Topic Chem 2 **Gravimetric Q# 94/** ALvl Chemistry/2010/s/TZ 1/ Paper 5/Q# 3/www.SmashingScience.org

3	(a)	ACE Data	Correctly computes (to a minimum of 2 decimal places) the table values for student 1, student 4 and student 7. <i>See appendix</i>	[1]
	(b)	ACE Data	Correctly reads from the graph (to within ½ small square) the mass of magnesium and corresponding mass of MgO for any point on the printed line.	[1]
	(c)	ACE Data	Shows by calculation that the coordinates do fit the formula of MgO. Evidence of two mole calculations needed. These could be the calculation of two mole values or the calculation of a theoretical mass from moles. A mole ratio that fits the formula of MgO OR the comparison of a theoretical mass with that measured from the plot, OR calculation of an M _r that fits MgO. Accept 1sf+ in mole values. Candidate may find any of the following ratios: Mg:O; Mg:MgO; MgO:O	[1]
	(d)	ACE Evaluation	(The mass of MgO is too low for the mass of magnesium taken). There needs to be a reason as to why the mass is low. Suggests that there has been loss of magnesium oxide as smoke or some has escaped with the lid off. Do not accept just "MgO too low or lost or spilled" OR Not all of the Mg has reacted.	[1]
	(e)	ACE Evaluation	Suggests the crucible lid has been omitted when weighing the magnesium oxide, OR different lid. Not loss of oxide since end mass < start mass.	[1]
	(f)	ACE Evaluation	Magnesium must have reacted with nitrogen. Accept forms magnesium nitride.	[1]
		Total		[6]

3 (a)

student	mass of crucible and lid / g	mass of crucible and lid + magnesium / g	mass of crucible and lid + magnesium oxide / g	mass of magnesium / g	mass of magnesium oxide / g
1	25.37	26.62	27.50	1.25	2.13
2	25.18	27.01	28.19	1.83	3.01
3	25.44	27.73	29.19	2.29	3.75
4	25.26	27.71	24.96	2.45	-0.30
5	25.39	28.11	29.84	2.72	4.45
6	25.04	27.89	28.54	2.85	3.50
7	25.13	28.08	29.93	2.95	<u>4.80</u>

Topic Chem 2 **Gravimetric Q# 95/** ALvl Chemistry/2013/s/TZ 1/ Paper 5/Q# 2/www.SmashingScience.org

2 (a)	151.9 AND 18.0	1																																																
(b)	Columns are headed with a label, an expression and units as below. Mol of FeSO_4 AND mol of H_2O are correct to 3 sig. figs. ECF incorrect M_r . ECF the use of incorrect expressions into data.	1 1																																																
	<table border="1"> <thead> <tr> <th>D</th> <th>E</th> <th>F</th> <th>G</th> </tr> </thead> <tbody> <tr> <td>FeSO_4 (C - A) / g</td> <td>H_2O B - C / g</td> <td>FeSO_4 (C - A) / 151.9 OR D / 151.9 mol OR mole</td> <td>H_2O (B - C) / 18 OR E / 18 mol OR mole</td> </tr> <tr> <td>1.00</td> <td>0.83</td> <td>0.00658</td> <td>0.0461</td> </tr> <tr> <td>1.31</td> <td>1.00</td> <td>0.00862</td> <td>0.0556</td> </tr> <tr> <td>1.30</td> <td>1.08</td> <td>0.00856</td> <td>0.0600</td> </tr> <tr> <td>1.39</td> <td>1.16</td> <td>0.00915</td> <td>0.0644</td> </tr> <tr> <td>1.50</td> <td>1.24</td> <td>0.00987</td> <td>0.0689</td> </tr> <tr> <td>1.63</td> <td>1.35</td> <td>0.0107</td> <td>0.0750</td> </tr> <tr> <td>1.78</td> <td>1.48</td> <td>0.0117</td> <td>0.0822</td> </tr> <tr> <td>1.84</td> <td>1.53</td> <td>0.0121</td> <td>0.0850</td> </tr> <tr> <td>1.95</td> <td>1.62</td> <td>0.0128</td> <td>0.0900</td> </tr> <tr> <td>2.03</td> <td>1.76</td> <td>0.0134</td> <td>0.0978</td> </tr> </tbody> </table>	D	E	F	G	FeSO_4 (C - A) / g	H_2O B - C / g	FeSO_4 (C - A) / 151.9 OR D / 151.9 mol OR mole	H_2O (B - C) / 18 OR E / 18 mol OR mole	1.00	0.83	0.00658	0.0461	1.31	1.00	0.00862	0.0556	1.30	1.08	0.00856	0.0600	1.39	1.16	0.00915	0.0644	1.50	1.24	0.00987	0.0689	1.63	1.35	0.0107	0.0750	1.78	1.48	0.0117	0.0822	1.84	1.53	0.0121	0.0850	1.95	1.62	0.0128	0.0900	2.03	1.76	0.0134	0.0978	
D	E	F	G																																															
FeSO_4 (C - A) / g	H_2O B - C / g	FeSO_4 (C - A) / 151.9 OR D / 151.9 mol OR mole	H_2O (B - C) / 18 OR E / 18 mol OR mole																																															
1.00	0.83	0.00658	0.0461																																															
1.31	1.00	0.00862	0.0556																																															
1.30	1.08	0.00856	0.0600																																															
1.39	1.16	0.00915	0.0644																																															
1.50	1.24	0.00987	0.0689																																															
1.63	1.35	0.0107	0.0750																																															
1.78	1.48	0.0117	0.0822																																															
1.84	1.53	0.0121	0.0850																																															
1.95	1.62	0.0128	0.0900																																															
2.03	1.76	0.0134	0.0978																																															

(c)	x-axis labelled 'mol of FeSO ₄ ' and y-axis 'mol H ₂ O' AND plotted points cover at least half the grid in both directions.	1
	Allow a correct letter from the table as a label.	
	All 10 points plotted correctly.	1
	Best fit straight line drawn.	1
(d)	Points 2 and 10 circled. (The circled points must be unambiguously referred to in the reasons.)	1
	Point 2 (mass of crucible 15.10) Not all the water had been driven off the iron sulfate crystals OR anhydrous FeSO ₄ absorbed some water OR has an impurity that does not decompose.	1
	Allow water loss is low(er) (than expected).	
	Point 10 (mass of crucible = 15.01) The anhydrous FeSO ₄ had decomposed OR prior to heating the crucible/original sample was wet and water removed on heating OR contained an impurity which decomposed/was removed on heating.	1
	Allow some mass lost (spits out) on heating.	
(e)	Appropriately drawn lines on the graph.	1
	Correctly read values from the graph.	1
	(Figures from the table allowed if no construction lines drawn providing graph drawn does actually go through the points used.)	
	Correctly calculated value of the slope given to 2 or more sig. figs up to calculator value and using the candidate's figures AND no units given.	1
(f)	Most of the points are on the line OR only a few points are not on the line OR there are only a few anomalies.	1
(g) (i)	FeSO ₄ .7H ₂ O (ecf on slope in (e))	1
(ii)	The gradient/slope is the ratio of (moles) of H ₂ O:FeSO ₄ (is 7 or 7:1).	1
		[Total: 15]

ASSESSMENT OF PLANNING SKILLS.

- (a) Give **one mark** if the apparatus is suitable for: heating and reducing the copper oxide in a stream of hydrogen gas.

Give **one mark** for "real apparatus" that:
is capable of being disconnected to weigh oxide/copper and water (*Ignore any chemical included to absorb condensate*);
shows how the steam is condensed to water.

Give **one mark** for a suitable means of burning excess hydrogen at the end of the apparatus. [3]

- (b) Give **one mark** for any of the following:

(i) flushing the apparatus with an inert gas,

(ii) passing hydrogen through the apparatus to flush out air,

(iii) testing small portions of mixture (e.g. in a test-tube) before igniting excess.

(iv) remove air from the apparatus – **by some practical method, e.g. evacuation** [1]

- (c) Give **one mark** for preventing copper from re-oxidising / keeping air away from the hot copper or equivalent. [1]

- (d) Give **one mark** for reference to reheating/reweighing or heating to constant mass. [1]

- (e) Give **one mark** for a calculation to obtain appropriate moles of CuO and Cu₂O, water, copper.

Give **one mark** for relating the calculated moles to quantities in the equation. [2]

[Total: 8]

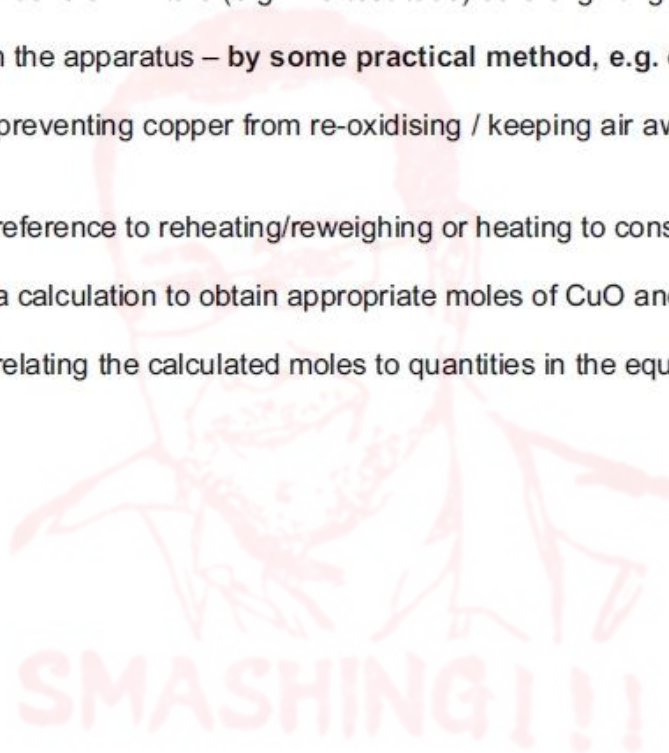

Question	Sections	Indicative material	Mark
2 (a)	ACE Data	<p>Correct headings for two or three of the following columns: mass of mercury chloride (B–A) mass of mercury (C–A) mass of chlorine (B–C) <i>Mass of chlorine can be obtained from mass of mercury chloride and mass of mercury (D–E or vice versa)</i> The correct equation must be included but units are not necessary in these columns</p>	[1]
		<p>Correct subtractions for all values (Allow 1 error only) <i>Each subtraction recorded to 1 decimal place (zero omitted in the 2nd decimal place is a separate error)</i></p>	[1]
(b)	ACE Data	<p>Plots, with correct labels – (not (D, E, F etc)) and units: mass of mercury against mass of mercury chloride or mass of chlorine against mass of mercury chloride <i>mass of mercury chloride must be on x axis (as independent variable)</i> or mass of mercury against mass of chlorine (either axes) <i>Candidate may convert masses to moles and plot the latter</i></p> <p>Suitable scales selected – data to be plotted over more than half of each axis</p> <p>Candidate plots all 8 points</p> <p>Candidate draws a straight line <u>which passes through (0,0) or would pass through (0,0) if extrapolated</u> and has a maximum number of points close to or on the line</p>	[1]
			[1]
			[1]
			[4]

Question	Sections	Indicative material	Mark	
(c)	ACE Evaluation	<p>Identifies any point(s) that do not lie on the line drawn Do not give this mark unless experiment 4 is one of the points identified If there are more points on the same side of the graph as (correctly plotted) data for experiment 4 the mass of Hg is too low Award marks as follows: (i) Refers to loss of mercury or <u>if mass of chlorine</u> has been plotted on one axis refers to too high a mass of chlorine [1] (ii) Reference to experimental method – describes mercury being poured away or reaction not going to completion [1] OR If there are more points on the <u>opposite</u> side of the graph as (correctly plotted) data for experiment 4 the mass of Hg is too high Award marks as follows: (i) Refers to mass of mercury being greater than expected/it should be or <u>if mass of chlorine</u> has been plotted on one axis refers to too low a mass of chlorine (ii) Reference to experimental method – describes mercury not being adequately dried (water or propanone) [1] If there are equal numbers of points on either side of the line <u>only award marks if the explanation is linked to relative position of the points and the line.</u> [1]</p>	[1]	[3]
(d)	ACE Evaluation	Refers to balance error or % error being less significant if larger masses are weighed	[1]	[1]
(e)	ACE Data	<p>Two construction lines <u>to graph</u> or one construction line <u>to graph</u> are seen on the graph and values of a pair of points or a single point are <u>correctly read</u> from the graph The points read from the graph should be used in some form of calculation e.g. calculating a gradient.</p> <p>Correctly calculates (using the candidate's figures from the graph) the value of x in HgCl_x and gives the formula with an integral value of x in the final answer <i>Where a candidate obtains a ratio of Hg:Cl of 1:1.5 accept Hg_2Cl_3 or Cl rounded up or down to 1 or 2 as appropriate.</i></p>	[1]	[2]

Question	Sections	Indicative material	Mark	
(f)	ACE Conclusions	Supporting evidence must be given <u>from and fit the data plotted</u> Suitable experimental method: Refers to a straight line, (passing through the origin), with few points off the line or Experimental method not suitable: Reverse argument to above or Suitable experimental method: Experimental data gives a value of x that is very close to an integer or Experimental method not suitable: Experimental data does not give an integral value of x	[1] [1]	[2]
(g)	ACE Conclusions	Soluble silver salt named e.g. silver nitrate/ AgNO ₃ <i>Accept Ag⁺(aq), solution containing Ag⁺ or solution containing silver(I)</i> <i>Do <u>not</u> accept Ag⁺ or silver</i> or Soluble lead(II) salt named e.g. lead nitrate/ Pb(NO ₃) ₂ <i>Accept Pb²⁺(aq), solution containing Pb²⁺ or solution containing lead(II)</i> <i>Do <u>not</u> accept Pb²⁺ or lead</i> <i>If formula or cation is given it must be correct</i> <i>Ignore any potential reaction of an anion in the reagent with Hg²⁺</i>	[1]	[1]
			[Total: 15]	

SMASHING!!!

Appendix

Data for Question 2

	A	B	C	D	E	F
expt	mass of beaker /g	mass of beaker + mercury chloride /g	mass of beaker + mercury /g	mass of mercury chloride /g	mass of mercury /g	mass of chlorine /g
				(B-A)	(C-A)	(B-C) (D-E)
1	54.87	55.52	55.30	0.65	0.43	0.22
2	54.64	55.88	55.59	1.24	0.95	0.29
3	56.70	58.38	57.94	1.68	1.24	0.44
4	51.03	53.34	52.53	2.31	1.50	0.81
5	55.33	58.74	57.84	3.41	2.51	0.90
6	53.05	57.20	56.10	4.15	3.05	1.10
7	53.92	58.57	57.17	4.65	3.25	1.40
8	55.26	61.09	59.57	5.83	4.31	1.52

Zero required as second decimal place. Treat each error as a separate error

Candidate plots the following masses:

y axis	x axis	equation
mercury	mercury chloride	slope x (201 + 35.5x) = 201
mercury chloride	mercury	slope x 201 = (201 + 35.5x)
chlorine	mercury chloride	slope x (201 + 35.5x) = 35.5x
mercury chloride	chlorine	slope x 35.5x = (201 + 35.5x)
mercury	chlorine	slope x 35.5x = 201
chlorine	mercury	slope x 201 = 35.5x



1 (a)	PLAN Problem	PbO 1:1, Pb ₃ O ₄ 1:1.33, PbO ₂ 1:2 All three correct two marks. Two correct one mark.	[2]
(b)	PLAN Problem	Correctly labelled axes and three straight lines drawn converging at the origin. Correct order of the lines. If 'O' is on the y-axis, order on axes is PbO ₂ (steepest gradient), Pb ₃ O ₄ , PbO. Allow 'Pb' on y-axis, order reversed.	[2]
(c)	PLAN Problem	(i) lead (allow lead oxide or oxide) AND (ii) oxygen (allow O ₂ OR lead)	[1]
(d)	PLAN Method	Diagram shows a heated piece of apparatus containing some lead oxide with hydrogen passing over it with inlet and outlet shown. Diagram shows apparatus to generate hydrogen using Mg/Al/Zn/Fe AND any dilute acid (labelled) OR group 1 metal/alcohol OR Ca with water or dilute acid. Shows excess hydrogen being burned OR led away from apparatus/collected.	[1] [1] [1]
(e)	PLAN Method	Chooses mass (M) of lead oxide between 1 g and 25g. Re-heats to constant mass. Calculates a volume of hydrogen sufficient to reduce the oxide. (mark is for the method, units are required.) Suggests calculating the moles of Pb and O/mole ratio of Pb to O.	[1] [1] [1] [1]
(f)	Plan Method	Hydrogen is explosive in air, so expel air from the apparatus before lighting flame to burn hydrogen OR lead/lead oxide is harmful/toxic, so wear a mask/use a fume cupboard to prevent inhalation of hydrogen/lead/lead oxide OR acids are corrosive/irritant, use chemically resistant gloves OR reduction tube is hot, allow to cool before handling/use heat resistant gloves/tongs.	[1]
(g)	PLAN Method	Columns are: mass/weight of the oxide; mass/weight of lead; mass/weight of oxygen; (mass units needed for these three) moles of lead; moles of oxygen; (no units). If five/four are fully correct, 2 marks, if only three/two are correct, 1 mark.	[2]
	Total		[15]

- (a) Give one mark for correct stoichiometry and state symbols for malachite.



Give one mark for correct stoichiometry for azurite.



[2]

- (b) Reward the following points (which are shown in the correct order):

a	Weigh the empty tube but not for taring the tube <i>Do not give this mark if for example an evaporating basin has been weighed and used for heating the sample</i>
b	Weigh the (tube) + mineral or Tared (tube) + mineral weighed or Known amount of mineral taken
c	Heat the mineral <i>Do not allow heating using a water-bath</i>
d	Cool and reweigh
e	(Continue heating and weighing) to constant mass (Reheating/reweighing twice can be accepted as heating to constant mass)

Deduct one mark from these potential five marks (no negative marks) for any of the following:

- (i) *the points are not awarded in a correct practical sequence or*
 (ii) *an unnecessary step (e.g. making a solution) has been introduced or*
 (iii) *apparatus has been used at this stage to collect/measure/test the gas(es) given off.*

[5]

- (c) (i) point (f) Give one mark if:
 the correct M_r for Malachite is seen = **221.0** and
 a calculation determines moles or masses of malachite and copper oxide
or
 the correct M_r for Azurite is seen = **344.5** and
 a calculation determines moles or masses of azurite and copper oxide

- (ii) point (g) Give one mark if:
 the equivalent M_r and calculation is seen for the other mineral and
 the moles or masses **compared and linked to the equations** to show the identity of
 the mineral

[2]

Both marks can be obtained from calculations that start with equal masses of malachite and azurite and show that azurite gives less CuO.

Accept $\frac{\text{mass of mineral}}{221}$ etc where the candidate has "invented" exemplar masses even if the values calculated do not illustrate the ratios from the equation.

Award point (g) if the correct process has been followed but an incorrect M_r has been used.

Do **NOT** give credit for M_r of azurite = 422 Formula of azurite read as $2(\text{CuCO}_3 \cdot \text{Cu}(\text{OH})_2)$

(d) Give one mark for any of the following:

- (i) measuring the volume of carbon dioxide evolved
- (ii) measuring mass of carbon dioxide and water vapour absorbed by soda-lime
- (iii) measuring mass of water absorbed by anhydrous calcium chloride, concentrated sulphuric acid or silica gel
- (iv) condensing water vapour and weighing the water collected

[1]

[Total for Question 2 10]

Topic Chem 27 **Gravimetric Q# 102/** ALVI Chemistry/2011/s/TZ 1/ Paper 5/Q# 2/www.SmashingScience.org

2 (a)	ACE Data	Both M_r s calculated correctly 85, 69, ignore units. May be seen in table.	[1]
(b)	ACE Data	Moles of NaNO_3 , B-A/ M_r , and full columns. Ignore units and moles of NaNO_2 , C-A/ M_r and full columns. Ignore units.	[1]
		All data correct and to 2 sig figs ECF incorrect M_r . Allow 2 arithmetic or sig fig errors. No ECF of incorrect formula. If no score, allow 1 for 1 full heading and 1 column correct in any combination.	[1]
(c)	ACE Data	Labelled axes (name and moles needed somewhere, nitrate to be the x-axis). Accept column label if its heading fully correct. Appropriate scaling (origin not necessary).	[1]
		Correctly plotted points. All 10 points need plotting. (Check points 1, 4, 7 & 10 and any that appear incorrect).	[1]
		Line of best fit which must go through 0,0.	[1]
(d)	ACE Evaluation	Give one mark if the two anomalous points furthest from the line (one on each side) are identified. Allow only one anomaly if there is only one or all the anomalies are on the same side. Allow extra anomalies due to misplotting. For credit, the anomalies must include the most anomalous. In plotting the points, it is possible that some points will be a little way from the correctly drawn line. These in many cases are likely not to be 'ringed'. Examiner judgement will be required in determining whether or not a point should be 'ringed'. If 5 or more points are 'ringed' do not award this mark but allow any subsequent correct discussion.	[1]
		Point 4 incomplete decomposition/not heated for long enough/not hot enough.	[1]

		One mark for two correct reasons not related to the points.	
(e)	ACE Data	Construction lines on graph. If line into origin and 0,0 used only 1 line necessary.	[1]
	ACE Conclusions	Takes intercept readings from the graph.	[1]
		Calculates the slope (independent mark). Do not accept calculations that give negative differences in x or y values.	[1]
(f)	ACE Conclusions	For stating that the slope supports the equation. ECF applies from incorrect gradient.	[1]
		For using the slope (1) and deducing a ratio (1:1). The mole relationship must be present. ECF incorrect ratio provided related to the above gradient.	[1]
	Total		[14]

Thermometric titration MS

Topic Chem 2 Thermometric titration MS Q# 103/ ALvl Chemistry/2005/s/TZ 1/ Paper 5/Q# 2/www.SmashingScience.org

2 (a) ACCURACY - CANDIDATE SCRIPTS

- (i) On the candidate's script circle the volume in Table 2.1 that produced the highest temperature for the Supervisor and the highest temperature recorded by the candidate.

Compare the volume of acid giving maximum temperature as recorded by the candidate and by the Supervisor.

Award a maximum of 2 accuracy marks as follows:

Mark		Where a candidate has the same temperature for consecutive volumes, use the first value. The expected maximum 30 or 33 cm ³
2	Max temp at same volume of FB 3 as Supervisor	
1	Max temp at Supervisor's volume of FB 3 \pm 3 cm ³	
0	Max temp at Supervisor's volume of FB 3 \pm more than 3 cm ³	

[2]

- (ii) On the candidate's script check, and correct where necessary the Δt value for the maximum temperature recorded.

Record the Supervisor's Δt value, ringed, against the table and calculate the difference in the Δt values between Supervisor and candidate.

Award accuracy marks as follows:

Mark	Difference in $\Delta t/^{\circ}\text{C}$	<i>Reduce this accuracy mark by one mark if any thermometer reading lacks a decimal place. Record (actual accuracy mark - 1) under Table 2.1 and the net accuracy mark in the mark column.</i>
3	up to 0.50	
2	0.50+ to 1.0	
1	1.0 to 1.5	
0	greater than 1.5	

[3]



In some Centres the Erratum slip was not received and the solutions prepared did not give a maximum temperature rise - the temperature continued to rise after each addition of acid.

If the Supervisor and the majority of candidates in a Centre have no maximum temperature rise award the first Accuracy marks (2 marks) as follows:

Calculate the difference in Δt values for Supervisor and candidate after the addition of 24.00 cm³ of FB 4. Record the Supervisor's value in a ring against the table in the usual way.

Give: 2 marks for a difference up to 0.5 °C
1 mark for a difference of 0.5+ °C to 1.0 °C
0 marks for a difference > 1.0 °C

Award the second Accuracy marks (3 marks) as before, comparing the Δt values at maximum temperature rise for candidate and Supervisor.

See later for changes to the mark scheme for the remainder of the question.

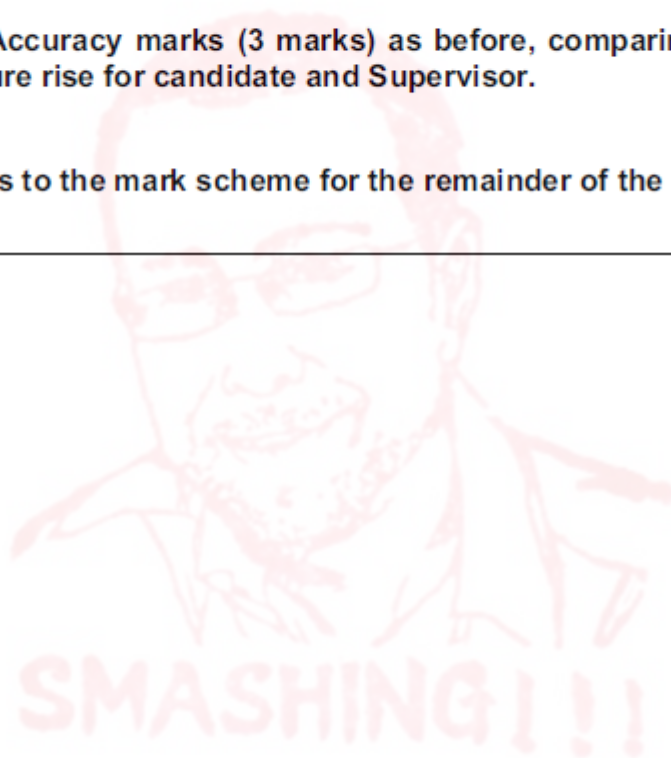

Graph

- (b) Give **one mark** if Δt is plotted on the y-axis, the volume of **FB 4** on the x-axis; the axes have been labelled (including unit) and sensible linear scales have been selected.

Give **one mark** if the candidate's Δt value at the maximum temperature recorded, and the Δt value for the volumes immediately before and after it have been plotted correctly. If two of these values are identical check the plotting of the next value away from the maximum that gives three different values of Δt .

The centre of the plotted point should be within $\frac{1}{2}$ small square on either axis.

If any of the three points above have not been plotted, check the nearest appropriate point in its place.

Give **one mark** if two distinct, appropriate **smooth** curves (lines) have been drawn, one showing the temperature rising and the other the temperature falling. The lines must intersect.

Do **not** give this mark if lines join all plotted points or the curves are rounded to meet at a particular volume at the maximum Δt value.

[3]

- (c) Give **one mark** for reading the end-point from the graph (within $\frac{1}{2}$ small square on either axis). This mark can be given from a rounded maximum or from the mid-point of a plateau.

This mark is not available where the candidate has recorded and plotted stepwise Δt values for each addition of acid.

[1]

- (d) Give **one mark** for
$$\frac{50}{\text{candidate's end - point from (c)}} \times 1.5$$
 or equivalent two stage calculation

[1]

- (e) Give **one mark** for 3.0 - answer to (d)

[1]

- (f) Give **one mark** for
$$\frac{42.40}{\text{answer to (e)}} \times 2 \quad \text{or} \quad \left(\frac{42.40}{\text{answer to (e)}} \right)$$

and

$$A_r = \frac{[\text{answer above} - 60]}{2}$$

Ignore units in this calculation

[1]

Where the Erratum slip had not been received and the Supervisor and majority of candidates at a Centre did not obtain a maximum temperature - the temperature continuing to rise after each addition of acid - mark the remainder of the question as below.

Graph

Give **one mark** if Δt is plotted on the y-axis, the volume of **FB 4** on the x-axis; the axes have been labelled (including unit) and sensible linear scales have been selected.

Give **one mark** if the candidate's value for Δt at 12 cm^3 , 18 cm^3 and 24 cm^3 have been plotted correctly. The centre of the plotted point should be within $\frac{1}{2}$ small square on each axis.

Give **one mark** for a smooth curve showing a good fit to the plotted points. [3]

(c) This mark is not available. [0]

(d) Give one mark for $\frac{50}{\text{candidate's end - point from (c)}} \times 1.5$

or equivalent two stage calculation. [1]

(e) Give one mark for 3.0 - answer to (d) [1]

(f) Give one mark for $\frac{42.40}{\text{answer to (e)}} \times 2$ or $\left(\frac{42.40}{2} \right)$

AND

Give one additional mark for $A_r = \frac{[\text{answer above} - 60]}{2}$ [2]

[Total: 12]

SMASHING!!!

1 (a)	PLAN Methods PLAN Problem	Selects a volume of 3 mol dm^{-3} NaOH between 10 and 80 cm^3 .	[1]
		Calculates the volume of 2 mol dm^{-3} H_2SO_4 that reacts with the volume of NaOH given. Ignore decimal places or significant figures. (ecf from (a) and accept 0.75x).	[1]
		Sketches a graph showing increasing temperature, reaching a maximum, then decreasing (or staying on plateau). AND indicating the neutralisation point at the maximum or the volume calculated above, Accept straight lines or curves with a maximum.	[1]
(b)	PLAN Problem	(i) volume of acid.	[1]
		(ii) temperature / temperature increase / temperature change.	[1]
		(iii) heat loss (given as being controlled) / use of same cup / apparatus. or same initial temperatures of both start solutions.	[1]
(c)	PLAN Methods	Burette / pipette to add acid.	[1]
(d)	PLAN Methods	The acid is added in successive volume portions (not dropwise). or adding the calculated acid volume in (a) slowly or gradually.	[1]
(e)	PLAN Methods	Risks or hazards identified (i) <u>apparatus</u> unstable (chemical spills on persons) or getting very hot / high heat / burns. Do not accept just temperature increase. Melting plastic is neutral. Do not accept irritant / harmful or itching or damage to clothing. (ii) NaOH is corrosive / burns / damage to skin. BOTH needed for mark. Do not accept burns twice.	[1]
(f)	PLAN Methods	Mark here is dependent on correct responses in (e). BOTH needed for mark. (i) plastic cup put in beaker / clamp for stability or appropriate handling of hot plastic cup. (ii) two of: gloves, face shield / goggles or lab coat in handling corrosive liquid. <i>Where only 1 risk and the associated way of minimising that risk are given – award one mark maximum for (e) and (f)</i>	[1]

(g)	PLAN Methods	EITHER A column for volume of acid added (in portions) with units and provision for an initial temperature at 0 cm ³ acid, or a separate statement of initial temperature or a separate column of initial temperature.	[1]
		WITH Columns for temperature and temperature change, both with units.	[1]
		OR Table indicates in some way multiple repeats of the same experiment. Must have a statement or column of acid volume.	OR [1]
		WITH Column for initial temperature, final temperature and temperature change, all with units. Only penalise unit error once.	[1]
(h)	PLAN Methods	$(\text{vol/mass NaOH} + \text{vol/mass H}_2\text{SO}_4) \times 4.3 \times \Delta T$ Added numerical values from (a) are required. Units not required. Conversion to kJ may be here.	[1]
(i)	PLAN Methods	Divides answer to (h) by moles of NaOH or water. Use of "n" or "moles" allowed if related to NaOH / H ₂ O	[1]
		Allow moles of H ₂ SO ₄ only if 2 × moles H ₂ SO ₄ used or 2 × value of moles H ₂ SO ₄ from part (a). Converts J to kJ in (h) or (i) AND gives –ve sign for an exothermic reaction. If values are used, calculations must be correct.	[1]
	Total		[15]

Topic Chem 7 **Thermometric titration Q# 105/** ALVI Chemistry/2005/w/TZ 1/ Paper 5/Q# 2/www.SmashingScience.org
2 Assessment of planning skills

(a) Outline Plan

Give **one mark** for mixing two pairs of solutions.
Do **not** give this mark if all three pairs have been mixed. [1]

Give **one mark** for stating that an acid/alkali pair will have a (large) temperature rise but an acid/acid pair will have no (or minimal) temperature change. [1]

Results

Give **one mark** for a suitable tabulation of results including units. [1]

Give **one mark** if one (or two) pair(s) show a significant temperature rise and one pair has virtually no temperature change

and

FB 5 is identified as the solution containing sodium hydroxide. [1]

(b) Give **one mark** for using twice the volume of sodium hydroxide compared to sulphuric acid. [1]

Give **one mark** for predicting that the temperature rise will be twice as great when 1.0 mol dm^{-3} sulphuric acid is used. [1]

Results

Give **one mark** for suitable tabulation of results.

Do **not** penalise absence of units if already penalised in (a).

Give **one mark** if initial temperatures are recorded for each solution.

Give **one mark** if one pair has approximately twice the temperature rise of the other pair. [3]

Identity

Give **one mark** if the solutions are correctly identified.

FB 3 is $0.05 \text{ mol dm}^{-3} \text{ H}_2\text{SO}_4$

FB 4 is $1.00 \text{ mol dm}^{-3} \text{ H}_2\text{SO}_4$

FB 5 is $1.00 \text{ mol dm}^{-3} \text{ NaOH}$

[Total for Question 2: 10 marks]

[Total for Paper: 30 marks]

Topic Chem 7 **Thermometric titration Q# 106/** ALVI Chemistry/2006/w/TZ 1/ Paper 5/Q# 1/www.SmashingScience.org

1 Give **one mark** if the temperature of solutions **FB 1** and **FB 2** and all maximum temperatures are recorded to one decimal place.
Withhold this mark if temperatures are recorded to 2 decimal places.

Give **one mark** if the average temperature, correct to 1 decimal place, has been calculated for **FB 1** and **FB 2** (*do not penalise decimal places twice*)
and the temperature rise for 0.07 mole (or 0.04 mole if appropriate) has been correctly calculated.

[2]

Accuracy

Record the Supervisor's standard, ringed, below the temperature rise box for experiment 2 (or experiment 5 if more appropriate).

Compare the candidate's temperature rise (corrected if necessary) for experiment 2 (or experiment 5 if more appropriate) with that obtained by the Supervisor.

Award marks as follows:

difference in $\Delta T / ^\circ\text{C}$	mark
0 to 0.5	4
0.5+ to 1.0	3
1.0+ to 2.0	2
2.0+ to 3.0	1
Greater than 3.0	0

[4]

- (a) Check the plotting of points for **0.08, 0.07, 0.04 and 0.03** mole of sodium hydroxide.
Give **two marks** if all four points have been correctly plotted.
Deduct one mark (no negative marks) for each point that has been incorrectly plotted.

Points that are on a vertical line of the grid (moles of NaOH) must be placed on the line – check the position of the centre of the cross or dot.

(Penalise an error in the precision of placing an otherwise correct point only once)
*If uncertain about the position of the centre of a cross or dot check the other plotted points.
Apply the penalty if there are two or more uncertainties*

points on the y-axis (ΔT) should be plotted in the correct small square and within $\frac{1}{2}$ small square of the position determined by the Examiner.

Also **deduct** from these two plotting marks (no negative marks) **one mark** for each of the following graphical errors:

- (i) moles of NaOH plotted on y-axis and ΔT plotted on the x-axis
- (ii) measured temperature (T) plotted instead of ΔT
- (iii) points are plotted in less than 4 large squares on either axis or
an inappropriate scale has been selected.

[2]

- (b) Give **one mark** if two straight lines have been drawn through the points and intersect.
Accept two straight lines that meet (and stop) providing there is no free-hand drawing where the lines meet.

Do not give this mark if curves have been drawn.

If solutions have been carefully prepared there should be 3 points on each straight line with an end point between 0.05 and 0.06 mole of sodium hydroxide.

[1]

- (c) Give **one mark** for correctly reading (correct to $\frac{1}{2}$ small square) the moles of sodium hydroxide at the end-point from the graph.

Accept a value from the intersection of
any two straight lines **or**
curves **or**
the maximum of the graph if the two lines have been rounded.

[1]

(d) Give one mark for correctly calculating the volume of sulphuric acid at the end-point:

Reacting Quantities	
moles of NaOH	volume of H ₂ SO ₄ / cm ³
0.08	10
0.07	15
0.06	20
0.05	25
0.04	30
0.03	35

[1]

Three ways of calculating the volume of H₂SO₄

(i) Volume of H₂SO₄ = 50 - $\frac{40}{0.08}$ x moles NaOH from graph

(ii) by inspection:

moles NaOH	0.050	0.052	0.054	0.056	0.058	0.060
Volume H ₂ SO ₄ /cm ³	25.00	24.00	23.00	22.00	21.00	20.00

(iii) calculates the volume of sodium hydroxide

$\frac{2.0 \times \text{volume}}{1000}$ = moles NaOH from graph, then calculates volume of H₂SO₄

volume of H₂SO₄ = 50 - volume of NaOH

(e) Give one mark for ans (c) x $\frac{1}{2}$

[1]

(f) Give one mark for ans (e) x $\frac{1000}{\text{ans (d)}}$

[1]

Enthalpy change

check and correct if necessary the subtractions in Table 1.3

calculate $\frac{\text{rise in temperature}}{\text{mass of FB 3}}$ correct to 1 decimal place

record the candidate's value alongside the Supervisor's value.

calculate, and record, the difference between the Supervisor and candidate.

Award accuracy marks as follows:

difference to Supervisor	mark
Up to 0.2	4
0.2+ to 0.4	3
0.4+ to 0.6	2
0.6+ to 1.0	1
Greater than 1.0	0

Deduct one mark from those awarded for accuracy (no negative marks) for each of the following:

- (i) in Table 1.3, any mass measurement has not been recorded to at least two decimal places.
(This does not apply to a calculated mass of FB 3.)
- (ii) there is a subtraction error in Table 1.3

[4]

- (g) Give one mark for $50 \times 4.3 \times (\text{candidate's temperature rise from Table 1.3})$ or $50 \times 4.3 \times (\text{candidate's temperature rise from Table 1.3}) \times \frac{1}{1000}$

[1]

- (h) Give one mark for either of these expressions:

(i) Moles of sodium hydroxide = $\frac{\text{mass from Table 1.3}}{40}$

(ii) Moles of sulphuric acid = $\frac{50}{1000} \times \text{concentration calculated in (f)}$ OR

Moles of sulphuric acid = $\frac{50}{1000} \times 1.5$

Give one further mark for both expressions and correct statement of the reagent in excess.

If (2 x moles of H_2SO_4) > moles of NaOH then H_2SO_4 is in excess.

If (2 x moles of H_2SO_4) < moles of NaOH then NaOH is in excess.

[2]



(i) Give one mark for the following:

If sulphuric acid is stated as in excess in (h),

$$\frac{\text{ans (g)}}{\text{moles of NaOH from (h)}} \times \frac{1}{1000}$$

If sodium hydroxide is in excess in (h),

$$\frac{\text{ans (g)}}{\text{moles of H}_2\text{SO}_4 \text{ from (h)}} \times \frac{1}{1000} \times \frac{1}{2}$$

Do not give this mark unless the numerical value is correctly in kJ.

Give one mark if a negative (-ve) sign is shown. *This is an independent mark.*

[2]

There are 22 marking points in question 1.

Record the marks awarded and cancel any marks in excess of 20, recording 20 Max.

[Total for Question 1 20 marks]

Topic Chem 7 **Thermometric titration Q# 107/** ALVI Chemistry/2015/w/TZ 1/ Paper 5/Q# 2/www.SmashingScience.org

2 (a)

Temperature rise / °C	barium hydroxide added / mol
1.2	0.00292
2.4	0.00585
3.7	0.00877
4.7	0.0117
7.3	0.0175
9.7	0.0234
10.4	0.0292
10.4	0.0351
10.4	0.0468

Values in temperature column correct and to 1 decimal place
Values in barium hydroxide column are correct and to 3 sig figs

[1]
[1]

(b) (i)	All points plotted correctly	[1]
(ii)	Two best-fit straight lines drawn and then levelling to a horizontal line	[1]
	The value on the x-axis is read correctly	[1]
(c)	The concentration of the acid is calculated as: $(2 \times \text{mol of Ba(OH)}_2) \times 1000 / 60$	[2]
(d)	Exothermic reaction	[1]
	After hydrochloric acid is neutralised/ fully reacted OR barium hydroxide is in excess the temperature (rise) is constant	[1]
(e) (i)	Loss of heat (to the surroundings)	[1]
	Greater temperature gradient OR the reaction is slower OR (rate of) heat loss is greater	[1]
(ii)	Give polystyrene cup a lid or cover/ use a finer powder	[1]
(f)	Line rises less steeply and intersects second line at a lower temperature rise	[1]
	Maximum is reached at the same mol of barium hydroxide as the experiment with hydrochloric acid	[1]
	Some of the heat that would have been released is used to ionise the ethanoic acid	[1]
Qn2		[Total: 15]

Important values, constants, and standards & The Periodic Table

Important values, constants and standards

molar gas constant	$R = 8.31 \text{ J K}^{-1} \text{ mol}^{-1}$
Faraday constant	$F = 9.65 \times 10^4 \text{ C mol}^{-1}$
Avogadro constant	$L = 6.022 \times 10^{23} \text{ mol}^{-1}$
electronic charge	$e = -1.60 \times 10^{-19} \text{ C}$
molar volume of gas	$V_m = 22.4 \text{ dm}^3 \text{ mol}^{-1}$ at s.t.p. (101 kPa and 273 K) $V_m = 24.0 \text{ dm}^3 \text{ mol}^{-1}$ at room conditions
ionic product of water	$K_w = 1.00 \times 10^{-14} \text{ mol}^2 \text{ dm}^{-6}$ (at 298 K (25°C))
specific heat capacity of water	$c = 4.18 \text{ kJ kg}^{-1} \text{ K}^{-1}$ (4.18 $\text{J g}^{-1} \text{ K}^{-1}$)

